

# bover

barcelona lights

Price list 2020

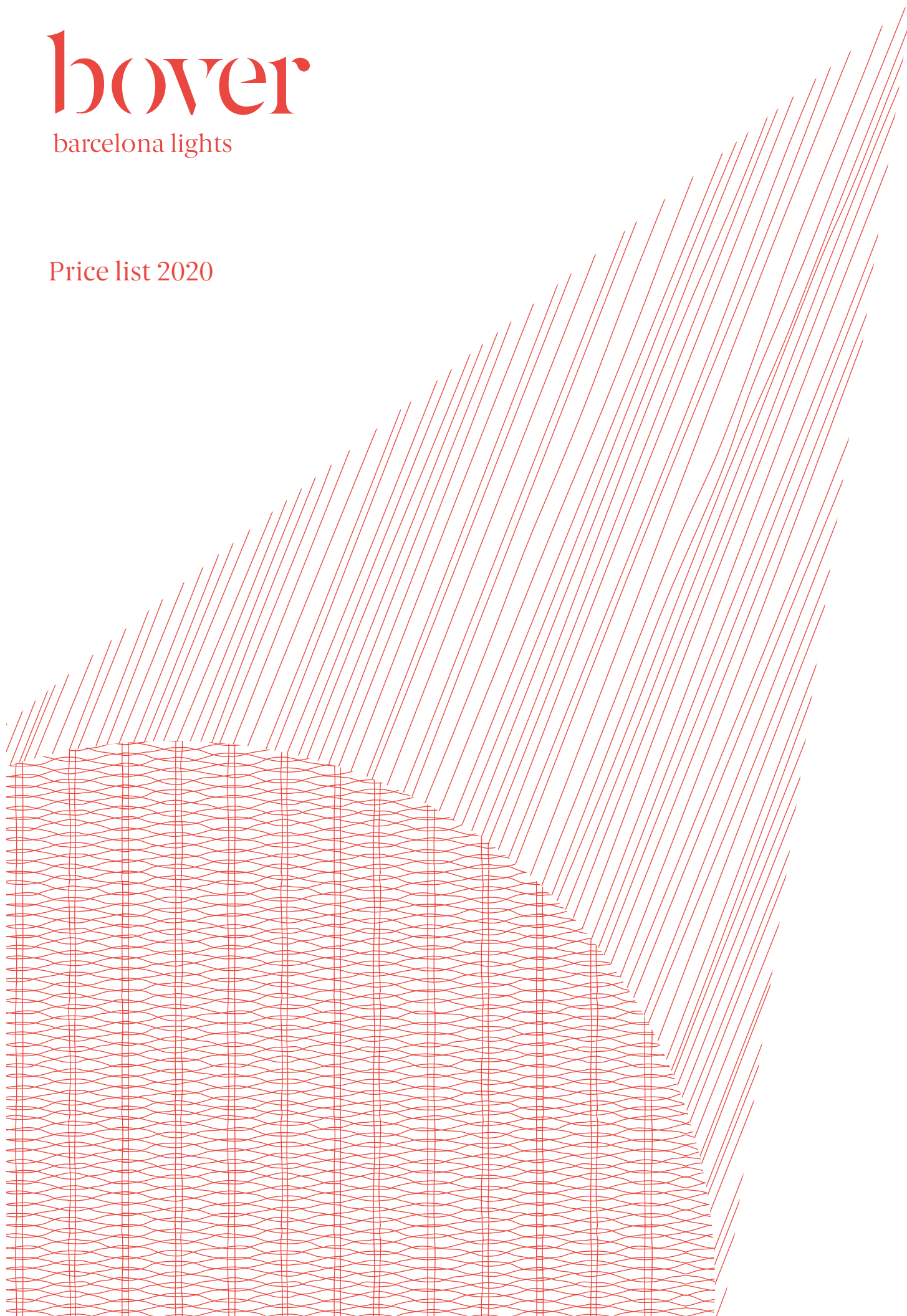



# hoyer

barcelona lights

*Price List 2020*  
Tarifa 2020

*Vat not included*  
Iva no incluido





# Índice / Index

## Exterior / Outdoor

Alba	6
Amphora	8
Atticus	12
Cornet	23
Elipse	68
Fora	78
Garota	84
Lineana	98
Marietta	102
Maxi	106
Moai	118
Sisal	155
Syra	180
Tria	193

## Interior / Indoor

### Apliques / Wall lamps

Alba	4
BCN	15
Beddy	17
Carlota	21
Drip/Drop	42
Flexo	76
Flexo Lexa	77
Lexa	95
Lexa FL	96
Liban	97
Nón Lá	131
Oval	139
Spock	177
Tria	187
Twall LED	195
Wall Street	203

### Suspensión / Pendant lamps

Danona	27
Dome	31
Domita	35
Drip/Drop	45
Drip/Drop Linear	59
Elea	64
Elipse	66
Hardy	94
Mar	101
Maxi	104
Mediterrània	108
Mei	110
Mod	123
Mos	126
Nón Lá	134
Oliver	138
Oval	142
Penta	145
Siam	153
Skybell	156
Slend	171
Syra	179
Tibeta	183
Urban	200

### Plafones / Ceiling lamps

Drip/Drop Linear	56
Elea	62
Mod	120
Oliver	137
Plafonet	146
Siam	149
Urban	196

### Mesa / Table lamps

Danona	28
Domita	41
Drip/Drop	52
Ema	74
Muf	129
Nón Lá	136
Oval	143
Spock	178
Tanit	182

### Pie / Floor lamps

Danona	30
Drip/Drop	55
Ema	75
Maxi	103

### Recambios y Accesorios

<i>Spare Parts &amp; Accessories</i>	207
--------------------------------------	-----

### Reguladores Triac

<i>Triac Dimmers</i>	212
----------------------	-----

### Especificaciones técnicas y condiciones de venta

<i>Technical Specifications &amp; Sales Conditions</i>	218
--	-----

# Alba 60

Diseño / Design:  
Rubén Saldaña / 2014

Tipología: Aplique  
Typology: Wall lamp

Ambiente: Interior  
Environment: Indoor

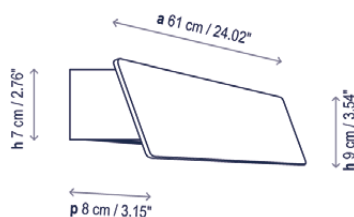

## Descripción técnica / Technical description:

Peso Neto: 3,16 kg  
Net Weight: 3,16 kg

1 Caja/Box | 18 x 80 x 15 cm | 0,0216 m<sup>3</sup>  
Peso bruto / Gross Weight: 3,85 kg

Materiales: Aluminio, Hierro, Madera  
Acabado Roble

Materials: Aluminum, Iron, Wood finish oak

Difusor inferior: Policarbonato  
Lower diffuser: Polycarbonate

Interruptor disponible bajo pedido  
Available switch upon request

Caja soporte: 58,7 x 7 cm  
Surface back box: 23.11" x 2.76"

Personalizable  
Customizable

Certificaciones  
Certifications

## Descripción lámpara / Lamps description:

230V 50Hz | IP-20 | 1-10V | 11,5 W LED / CRI: 90 / 2700<sup>o</sup>K  
1060 lm fuente de luz / light source

Ref	Acabados / Finishing	Ean13	Euros
2270101165	Regulable 1-10v - LED Blanco Dimmable 1-10v - LED White	8435493723426	340,00
2270101163	Regulable 1-10v - LED Blanco - Madera Roble Dimmable 1-10v - LED White - Oak Wood	8435493724065	380,00

## Familia / Family: Alba

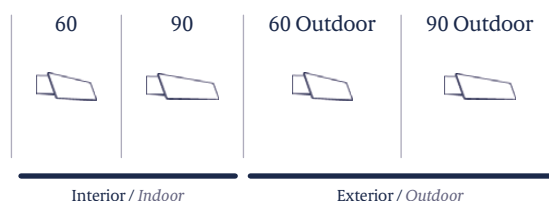

# Alba 90

Diseño / Design:  
Rubén Saldaña / 2014

Tipología: Aplique  
Typology: Wall lamp

Ambiente: Interior  
Environment: Indoor

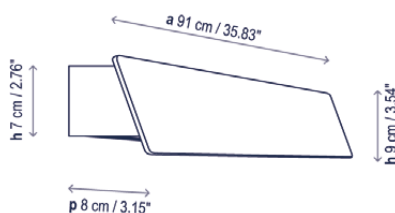

## Descripción técnica / Technical description:

Peso Neto: 4,56 kg  
Net Weight: 4,56 kg

1 Caja/Box | 18 x 19 x 117 cm | 0,04 m<sup>3</sup>  
Peso bruto / Gross Weight: 5,47 kg

Materiales: Aluminio, Hierro, Madera  
Acabado Roble

Materials: Aluminum, Iron, Wood finish oak

Difusor inferior: Policarbonato  
Lower diffuser: Polycarbonate

Interruptor disponible bajo pedido  
Available switch upon request

Caja soporte: 88,7 x 7 cm  
Surface back box: 34.92" x 2.76"

Personalizable  
Customizable

Certificaciones  
Certifications

## Descripción lámpara / Lamps description:

230V 50Hz | IP-20 | 1-10V | 17 W LED / CRI: 90 / 2700°K  
1600 lm fuente de luz / light source

Ref	Acabados / Finishing	Ean13	Euros
2270201165	Regulable 1-10v - LED Blanco Dimmable 1-10v - LED White	8435493725291	425,00
2270201163	Regulable 1-10v - LED Blanco - Madera Roble Dimmable 1-10v - LED White - Oak Wood	8435493725239	485,00

## Familia / Family: Alba

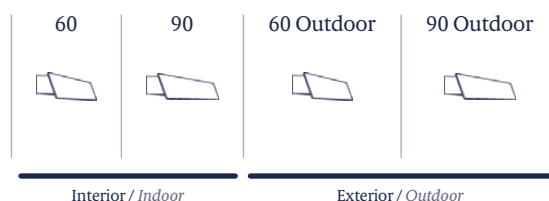

# Alba 60 Outdoor

Diseño / Design:  
Rubén Saldaña / 2014

Tipología: Aplique  
Typology: Wall lamp

Ambiente: Exterior  
Environment: Outdoor

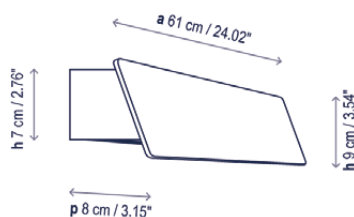

## Descripción técnica / Technical description:

Peso Neto: 3,16 kg  
Net Weight: 3,16 kg

1 Caja/Box | 18 x 80 x 15 cm | 0,0216 m<sup>3</sup>  
Peso bruto / Gross Weight: 3,85 kg

Materiales: Acero Inoxidable, Aluminio  
Materials: Stainless steel, Aluminum

Difusor inferior: Policarbonato  
Lower diffuser: Polycarbonate

Estructuras de metal acabadas con cataforesis y pintura de poliéster epoxi.  
Metal surfaces coated with cathaphoresis and epoxy polyester paint.

Caja soporte: 58,7 x 7 cm  
Surface back box: 23.11" x 2.76"

Personalizable  
Customizable

Certificaciones  
Certifications

## Descripción lámpara / Lamps description:

230V 50Hz | IP-66 | 11,5 W LED / CRI: 90 / 3000°K | 1060 lm fuente de luz / light source

Ref	Acabados / Finishing	Ean13	Euros
2270100614	LED Marrón Grafito LED Brown Graphite	8436544893808	485,00

## Familia / Family: Alba

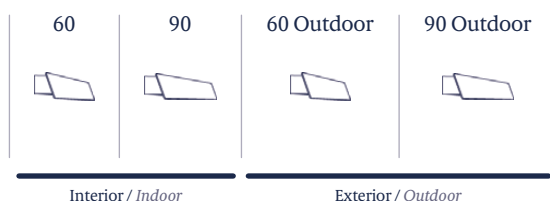



# Alba 90 Outdoor

Diseño / Design:  
Rubén Saldaña / 2014

Tipología: Aplique  
Typology: Wall lamp

Ambiente: Exterior  
Environment: Outdoor

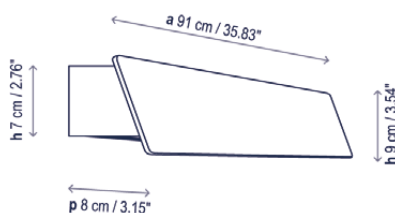

## Descripción técnica / Technical description:

Peso Neto: 4,56 kg  
Net Weight: 4,56 kg

1 Caja/Box | 18 x 19 x 117 cm | 0,04 m<sup>3</sup>  
Peso bruto / Gross Weight: 5,47 kg

Materiales: Acero Inoxidable, Aluminio  
Materials: Stainless steel, Aluminum

Difusor inferior: Policarbonato  
Lower diffuser: Polycarbonate

Estructuras de metal acabadas con cataforesis y pintura de poliéster epoxi.  
Metal surfaces coated with cathaphoresis and epoxy polyester paint.

Caja soporte: 88,7 x 7 cm  
Surface back box: 34.92" x 2.76"

Personalizable  
Customizable

Certificaciones  
Certifications

## Descripción lámpara / Lamps description:

230V 50Hz | IP-66 | 17 W LED / CRI: 90 / 3000<sup>o</sup>K | 1600 lm fuente de luz / light source

Ref	Acabados / Finishing	Ean13	Euros
2270200614	LED Marrón Grafito LED Brown Graphite	8436544893914	536,00

## Familia / Family: Alba

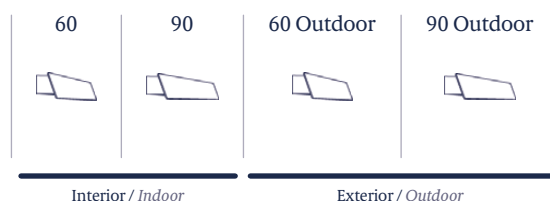

# Amphora

Diseño / Design:

Alex Fernández Camps | Gonzalo Milà / 2013

Tipología: Pie

Typology: Floor lamp

Ambiente: Exterior

Environment: Outdoor

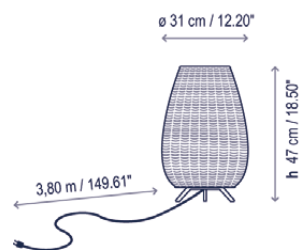

## Descripción técnica / Technical description:

Peso Neto: 2,23 kg  
Net Weight: 2,23 kg

1 Caja/Box | 32 x 32 x 66 cm | 0,07 m<sup>3</sup>  
Peso bruto / Gross Weight: 3,16 kg

Materiales: Aluminio, Polietileno, Fibra Sintética.

Materials: Aluminum, Polyethylene, Synthetic fiber.

Estructuras de metal acabadas con cataforesis y pintura de poliéster epoxi.

Metal surfaces coated with cataphoresis and epoxy polyester paint.

Pantallas tejidas a mano con fibra de polietileno sintética reciclable y no tóxica. Fuente de luz protegida por globo de polietileno y protección UV.

Hand woven with a recyclable and non-toxic synthetic polyethylene fiber. Light source protected by UV resistant polyethylene globe.

Cable sin interruptor, de neopreno negro resistente al agua.

Black waterproof neoprene cable without switch.

Personalizable: consultar

Customizable: consult

Certificaciones  
Certifications



Accesorios / Accessories:

R3300114 Anclaje marrón / Brown anchorage

## Descripción lámpara / Lamps description:

230V 50Hz | IP-66 | 8 W LED / CRI: 90 / 2700°K  
544 lm fuente de luz / light source

Ref	Acabados / Finishing	Ean13	Euros
0033003/P833	Marrón - Pantalla Beige Claro* Brown - Light Beige Shade*	8435493723938	290,00
0033003/P832	Marrón - Pantalla Marrón Rattan* Brown - Rattan Brown Shade*	8435493723983	290,00

\*Por favor, tenga en cuenta que los tonos de color de la pantalla pueden no ser los mismos en todos los casos. / Please note that the shades may have small variations in tone.

Nota de uso: Para ambientes con alto grado de salinidad, será necesario realizar un correcto mantenimiento de la luminaria. Recomendamos limpiar con un cepillo suave y retirar la sal, el polvo, o la suciedad depositada por la humedad o el viento.

Note of use: For environments with a high salinity, proper maintenance of the luminaire will be necessary. We recommend cleaning it with a soft brush and remove salt, dust, or dirt deposited by moisture or wind.

Familia / Family: Amphora

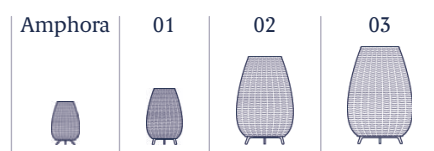

# Amphora 01

Diseño / Design:

Alex Fernández Camps | Gonzalo Milà / 2013

Tipología: Pie

Typology: Floor lamp

Ambiente: Exterior

Environment: Outdoor

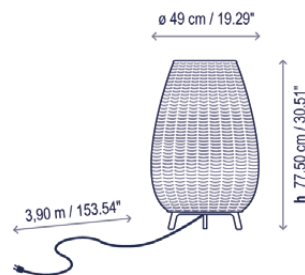

## Descripción técnica / Technical description:

Peso Neto: 5,87 kg  
Net Weight: 5,87 kg

1 Caja/Box | 55 x 54 x 86 cm | 0,2554 m<sup>3</sup>  
Peso bruto / Gross Weight: 9,65 kg

Materiales: Aluminio, Acero Inoxidable, Polietileno, Fibra Sintética.

Materials: Aluminum, Stainless steel, Polyethylene, Synthetic fiber.

Estructuras de metal acabadas con cataforesis y pintura de poliéster epoxi.

Metal surfaces coated with cathaphoresis and epoxy polyester paint.

Pantallas tejidas a mano con fibra de polietileno sintética reciclable y no tóxica. Fuente de luz protegida por globo de polietileno y protección UV.

Hand woven with a recyclable and non-toxic synthetic polyethylene fiber. Light source protected by UV resistant polyethylene globe.

Cable sin interruptor, de neopreno negro resistente al agua. Instalación eléctrica fija disponible bajo pedido.

Black waterproof neoprene cable without switch. Hardwired version upon request.

Personalizable: consultar  
Customizable: consult

Bombillas no incluidas  
Bulbs not included

Certificaciones  
Certifications

Accesorios / Accessories:

R33014 Anclaje marrón / Brown anchorage

## Descripción lámpara / Lamps description:

230V 50Hz | IP-66 2 x 22 W CFL E-27 | 2 x 9 W LED E-27 A60

Ref	Acabados / Finishing	Ean13	Euros
0133003/P741	Marrón - Pantalla Beige Claro* Brown - Light Beige Shade*	8435493700397	910,00
0133003/P742	Marrón - Pantalla Marrón Rattan* Brown - Rattan Brown Shade*	8435493700403	910,00

\*Por favor, tenga en cuenta que los tonos de color de la pantalla pueden no ser los mismos en todos los casos. / Please note that the shades may have small variations in tone.

Nota de uso: Para ambientes con alto grado de salinidad, será necesario realizar un correcto mantenimiento de la luminaria. Recomendamos limpiar con un cepillo suave y retirar la sal, el polvo, o la suciedad depositada por la humedad o el viento.

Note of use: For environments with a high salinity, proper maintenance of the luminaire will be necessary. We recommend cleaning it with a soft brush and remove salt, dust, or dirt deposited by moisture or wind.

Familia / Family: Amphora

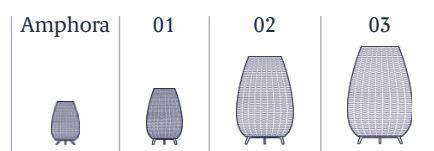

# Amphora 02

Diseño / Design:

Alex Fernández Camps | Gonzalo Milà / 2013

Tipología: Pie

Typology: Floor lamp

Ambiente: Exterior

Environment: Outdoor

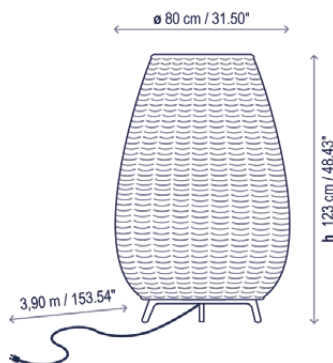

## Descripción técnica / Technical description:

Peso Neto: 14,25 kg  
Net Weight: 14,25 kg

### Opcional/ Optional:

1 Caja/Box | 97 x 97 x 145 cm | 1,3643 m<sup>3</sup>  
Peso bruto / Gross Weight: 20,93 kg

1 Caja Madera/Wood Box  
97 x 97 x 149 cm | 1,4019 m<sup>3</sup>  
Peso bruto / Gross Weight: 55,75 kg

Materiales: Aluminio, Acero Inoxidable, Polietileno, Fibra Sintética.

Materials: Aluminum, Stainless steel, Polyethylene, Synthetic fiber.

Estructuras de metal acabadas con cataforesis y pintura de poliéster epoxi.

Metal surfaces coated with cathaphoresis and epoxy polyester paint.

Pantallas tejidas a mano con fibra de polietileno sintética reciclable y no tóxica. Fuente de luz protegida por globo de polietileno y protección UV.

Hand woven with a recyclable and non-toxic synthetic polyethylene fiber. Light source protected by UV resistant polyethylene globe.

Cable sin interruptor, de neopreno negro resistente al agua. Instalación eléctrica fija disponible bajo pedido.

Black waterproof neoprene cable without switch. Hardwired version upon request.

Personalizable: consultar

Customizable: consult

Bombillas no incluidas

Bulbs not included

Certificaciones

Certifications



Accesorios / Accessories:

R33014 Anclaje marrón / Brown anchorage

## Descripción lámpara / Lamps description:



Ref	Acabados / Finishing	Ean13	Euros
0233003/P744	Marrón - Pantalla Beige Claro* Brown - Light Beige Shade*	8435493700656	1.389,00
0233003/P745	Marrón - Pantalla Marrón Rattan* Brown - Rattan Brown Shade*	8435493700663	1.389,00

\*Por favor, tenga en cuenta que los tonos de color de la pantalla pueden no ser los mismos en todos los casos. / Please note that the shades may have small variations in tone.

Nota de uso: Para ambientes con alto grado de salinidad, será necesario realizar un correcto mantenimiento de la luminaria. Recomendamos limpiar con un cepillo suave y retirar la sal, el polvo, o la suciedad depositada por la humedad o el viento.

Note of use: For environments with a high salinity, proper maintenance of the luminaire will be necessary. We recommend cleaning it with a soft brush and remove salt, dust, or dirt deposited by moisture or wind.

## Familia / Family: Amphora

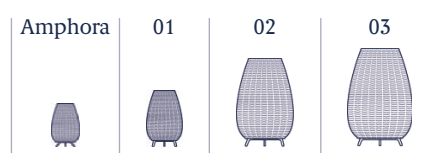

# Amphora 03

Diseño / Design:  
Alex Fernández Camps | Gonzalo Milà / 2013

Tipología: Pie  
Typology: Floor lamp

Ambiente: Exterior  
Environment: Outdoor

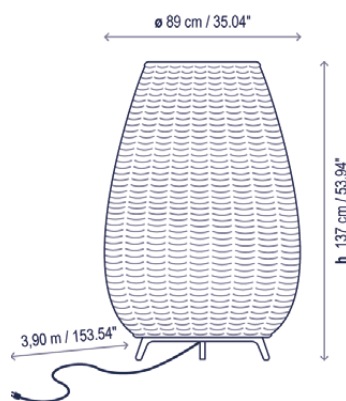

## Descripción técnica / Technical description:

Peso Neto: 15,35 kg  
Net Weight: 15,35 kg

### Opcional/ Optional:

1 Caja/Box | 97 x 97 x 159 cm | 1,496 m<sup>3</sup>  
Peso bruto / Gross Weight: 22,03 kg

1 Caja Madera/Wood Box  
97 x 97 x 149 cm | 1,4019 m<sup>3</sup>  
Peso bruto / Gross Weight: 56,85 kg

Materiales: Aluminio, Acero Inoxidable,  
Polietileno, Fibra Sintética.

Materials: Aluminum, Stainless steel,  
Polyethylene, Synthetic fiber.

Estructuras de metal acabadas con cataforesis  
y pintura de poliéster epoxi.

Metal surfaces coated with cataphoresis and  
epoxy polyester paint.

Pantallas tejidas a mano con fibra de  
polietileno sintética reciclable y no tóxica.  
Fuente de luz protegida por globo de  
polietileno y protección UV.

Hand woven with a recyclable and non-toxic  
synthetic polyethylene fiber. Light source  
protected by UV resistant polyethylene globe.

Cable sin interruptor, de neopreno negro  
resistente al agua. Instalación eléctrica fija  
disponible bajo pedido.

Black waterproof neoprene cable without  
switch. Hardwired version upon request.

Personalizable: consultar  
Customizable: consult

Bombillas no incluidas  
Bulbs not included

Certificaciones  
Certifications

### Accesorios / Accessories:

R33014 Anclaje marrón / Brown anchorage

## Descripción lámpara / Lamps description:

230V  
50Hz IP-66 2 x 30 W CFL E-27 2 x 9 W LED E-27 A60

Ref	Acabados / Finishing	Ean13	Euros
0333003/P747	Marrón - Pantalla Beige Claro* Brown - Light Beige Shade*	8435493700915	1.618,00
0333003/P748	Marrón - Pantalla Marrón Rattan* Brown - Rattan Brown Shade*	8435493700922	1.618,00

\*Por favor, tenga en cuenta que los tonos de color de la pantalla pueden no ser los mismos en todos los casos. / Please note that the shades may have small variations in tone.

Nota de uso: Para ambientes con alto grado de salinidad, será necesario realizar un correcto mantenimiento de la luminaria. Recomendamos limpiar con un cepillo suave y retirar la sal, el polvo, o la suciedad depositada por la humedad o el viento.

Note of use: For environments with a high salinity, proper maintenance of the luminaire will be necessary. We recommend cleaning it with a soft brush and remove salt, dust, or dirt deposited by moisture or wind.

## Familia / Family: Amphora

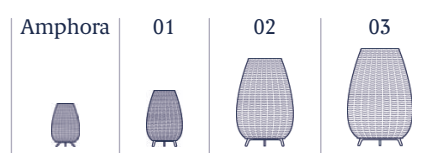



# Atticus B/56 - B/66 Outdoor

Diseño / Design:  
Joana Bover / 2017

Tipología: Baliza  
Typology: Bollard

Ambiente: Exterior  
Environment: Outdoor

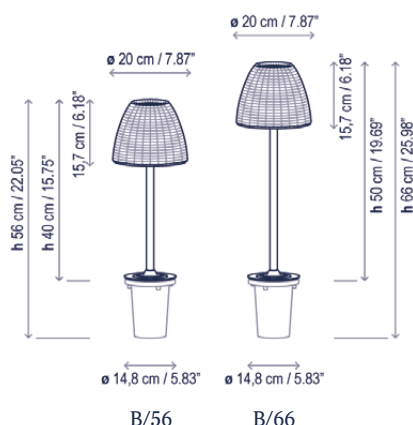

## Descripción técnica / Technical description:

### Atticus B/56

Peso Neto: 1,81 kg  
Net Weight: 1,81 kg

1 Caja/Box | 32 x 32 x 66 cm | 0,0676 m<sup>3</sup>  
Peso bruto / Gross Weight: 2,89 kg

### Atticus B/66

Peso Neto: 1,92 kg  
Net Weight: 1,92 kg

1 Caja/Box | 26 x 27 x 72 cm | 0,0505 m<sup>3</sup>  
Peso bruto / Gross Weight: 2,9 kg

Materiales: Aluminio, Acero inoxidable, Polietileno, Fibra sintética.  
Materials: Aluminum, Stainless steel, Polyethylene, Synthetic fiber.

Estructuras de metal acabadas con cataforesis y pintura de poliéster epoxi.  
Metal surfaces coated with cathaphoresis and epoxy polyester paint.

Pantallas tejidas a mano con fibra de polietileno sintética reciclable y no tóxica. Fuente de luz protegida por globo de polietileno y protección UV.  
Hand woven with a recyclable and non-toxic synthetic polyethylene fiber. Light source protected by UV resistant polyethylene globe.

No incluye tacos de sujeción a superficie. Sistema de regulación TRIAC sin interruptor.  
TRIAC Dimming system without switch. Does not include clampings lugs to surface.

Consulte la tabla de reguladores TRIAC recomendados en la página 212.  
Please check the list of recommended TRIAC dimmers at page 212.

Personalizable: acabado y altura  
Customizable: finishing and height

Certificaciones  
Certifications



## Descripción lámpara / Lamps description:

230V 50Hz | IP-66 | 9 W LED / CRI: 90 / 2700°K  
960 lm fuente de luz / light source

Ref / Atticus B/56	Acabados / Finishing	Ean13	Euros
3100440040	Regulable Triac - Blanco Roto Pantalla Beige Claro* Dimmable Triac - Natural White Light Beige Shade*	8436544897806	387,00
3100440003	Regulable Triac - Marrón Grafito Pantalla Marrón* Dimmable Triac - Graphite Brown Brown Shade*	8436544897677	387,00
Ref / Atticus B/66	Acabados / Finishing	Ean13	Euros
3100540040	Regulable Triac - Blanco Roto Pantalla Beige Claro* Dimmable Triac - Natural White Light Beige Shade*	8436544897813	393,00
3100540003	Regulable Triac - Marrón Grafito Pantalla Marrón* Dimmable Triac - Graphite Brown Brown Shade*	8436544897691	393,00

\*Por favor, tenga en cuenta que los tonos de color de la pantalla pueden no ser los mismos en todos los casos. / Please note that the shades may have small variations in tone.

Nota de uso: Para ambientes con alto grado de salinidad, será necesario realizar un correcto mantenimiento de la luminaria. Recomendamos limpiar con un cepillo suave y retirar la sal, el polvo, o la suciedad depositada por la humedad o el viento.  
Note of use: For environments with a high salinity, proper maintenance of the luminaire will be necessary. We recommend cleaning it with a soft brush and remove salt, dust, or dirt deposited by moisture or wind.

## Familia / Family: Atticus

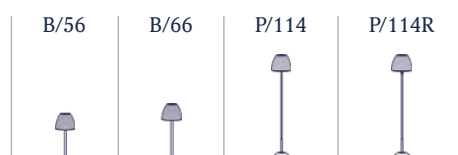

# Atticus P/114 Outdoor

Diseño / Design:  
Joana Bover / 2017

Tipología: Pie  
Typology: Floor lamp

Ambiente: Exterior  
Environment: Outdoor

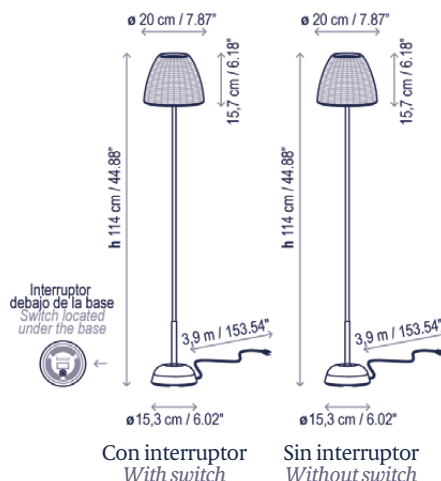

## Descripción técnica / Technical description:

Peso Neto: 2,15 kg  
Net Weight: 2,15 kg

1 Caja/Box | 29 x 28 x 132 cm | 0,1072 m<sup>3</sup>  
Peso bruto / Gross Weight: 4,7 kg

Materiales: Aluminio, Acero inoxidable, Polietileno, Fibra sintética, Latón.  
Materials: Aluminum, Stainless steel, Polyethylene, Synthetic fiber, Brass.

Estructuras de metal acabadas con cataforesis y pintura de poliéster epoxi.  
Metal surfaces coated with cataphoresis and epoxy polyester paint.

Pantallas tejidas a mano con fibra de polietileno sintética reciclable y no tóxica. Fuente de luz protegida por globo de polietileno y protección UV.  
Hand woven with a recyclable and non-toxic synthetic polyethylene fiber. Light source protected by UV resistant polyethylene globe.

Cable de neopreno negro resistente al agua. Interruptor debajo la base.  
Black waterproof neoprene cable. Switch located under the base.

Personalizable: acabado y altura  
Customizable: finishing and height

Certificaciones  
Certifications



## Descripción lámpara (con interruptor) / Lamps description (with switch):

230V 50HZ | IP-66 | 9 W LED / CRI: 90 / 2700°K  
960 lm fuente de luz / light source

Ref	Acabados / Finishing	Ean13	Euros
3100230240	Blanco Roto - Pantalla Beige Claro* Natural White - Light Beige Shade*	8436544897790	494,00
3100230203	Marrón Grafito - Pantalla Marrón* Graphite Brown - Brown Shade*	8436544896601	494,00

## Descripción lámpara (sin interruptor) / Lamps description (without switch):

230V 50HZ | IP-66 | 9 W LED / CRI: 90 / 2700°K  
960 lm fuente de luz / light source

Ref	Acabados / Finishing	Ean13	Euros
3100330140	Blanco Roto - Pantalla Beige Claro* Natural White - Light Beige Shade*	8436544897783	489,00
3100330103	Marrón Grafito - Pantalla Marrón* Graphite Brown - Brown Shade*	8436544896625	489,00

\*Por favor, tenga en cuenta que los tonos de color de la pantalla pueden no ser los mismos en todos los casos. / Please note that the shades may have small variations in tone.

Nota de uso: Para ambientes con alto grado de salinidad, será necesario realizar un correcto mantenimiento de la luminaria. Recomendamos limpiar con un cepillo suave y retirar la sal, el polvo, o la suciedad depositada por la humedad o el viento.  
Note of use: For environments with a high salinity, proper maintenance of the luminaire will be necessary. We recommend cleaning it with a soft brush and remove salt, dust, or dirt deposited by moisture or wind.

## Familia / Family: Atticus

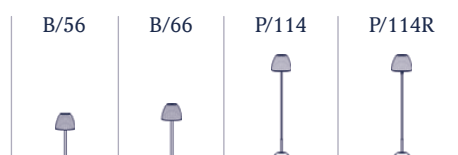

# Atticus P/114/R Outdoor

Diseño / Design:  
Joana Bover / 2017

Tipología: Pie  
Typology: Floor lamp

Ambiente: Exterior  
Environment: Outdoor



## Descripción técnica / Technical description:

Peso Neto: 2,83 kg  
Net Weight: 2,83 kg

1 Caja/Box | 29 x 28 x 132 cm | 0,1072 m<sup>3</sup>  
Peso bruto / Gross Weight: 4,85 kg

Materiales: Aluminio, Acero inoxidable, Polietileno, Fibra sintética, Latón.  
Materials: Aluminum, Stainless steel, Polyethylene, Synthetic fiber, Brass.

Estructuras de metal acabadas con cataforesis y pintura de poliéster epoxi.  
Metal surfaces coated with cataphoresis and epoxy polyester paint.

Pantallas tejidas a mano con fibra de polietileno sintética reciclable y no tóxica. Fuente de luz protegida por globo de polietileno y protección UV.  
Hand woven with a recyclable and non-toxic synthetic polyethylene fiber. Light source protected by UV resistant polyethylene globe.

Interruptor On-Off. Operativa 50% 100%.  
Tiempo de carga: +/- 5.30 horas.  
Duración batería al 100%: +/- 5 horas.  
Duración batería al 50%: +/- 11 horas.  
Cargador batería incluido (100-240V 50/60Hz).

On-Off Switch. Operation 50% 100%.  
Battery charging time: +/- 5.30 hours.  
Battery duration time at 100%: +/- 5 hours.  
Battery duration time at 50%: +/- 11 hours.  
Battery charger included (100-240V 50/60Hz).

Personalizable: acabado y altura  
Customizable: finishing and height

Certificaciones  
Certifications

Recambios / Spare parts:

R950001 Batería / Battery

## Descripción lámpara / Lamps description:

5Vdc 1,5A | IP-66 | 3,2 W LED / CRI: 90 / 2700°K  
400 lm fuente de luz / light source

Ref	Acabados / Finishing	Ean13	Euros
3100130940	Blanco Roto - Pantalla Beige Claro* Natural White - Light Beige Shade*	8436544897776	587,00
3100130903	Marrón Grafito - Pantalla Marrón* Graphite Brown - Brown Shade*	8436544896595	587,00

\*Por favor, tenga en cuenta que los tonos de color de la pantalla pueden no ser los mismos en todos los casos. / Please note that the shades may have small variations in tone.

Nota de uso: Para ambientes con alto grado de salinidad, será necesario realizar un correcto mantenimiento de la luminaria. Recomendamos limpiar con un cepillo suave y retirar la sal, el polvo, o la suciedad depositada por la humedad o el viento.  
Note of use: For environments with a high salinity, proper maintenance of the luminaire will be necessary. We recommend cleaning it with a soft brush and remove salt, dust, or dirt deposited by moisture or wind.

## Familia / Family: Atticus

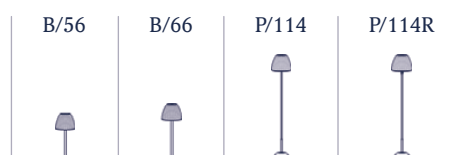



# BCN 01

Diseño / Design:  
Joana Bover / 2012

Tipología: Aplique  
Typology: Wall lamp

Ambiente: Interior  
Environment: Indoor

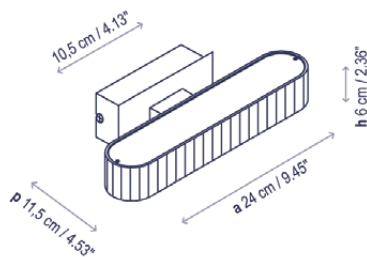

## Descripción técnica / Technical description:

Peso Neto: 1,28 kg  
Net Weight: 1,28 kg

1 Caja/Box | 36 x 14 x 13 cm | 0,0066 m<sup>3</sup>  
Peso bruto / Gross Weight: 1,57 kg

Materiales: Hierro  
Materials: Iron

Difusor superior e inferior: Policarbonato  
Upper and lower diffusers: Polycarbonate

Caja soporte: 10,5 x 5 cm  
Surface back box: 4.13" x 1.97"

Hilo incandescente pantalla: 960°  
Shade GWFI: 960°

Consulte la tabla de reguladores TRIAC recomendados en la página 212.  
Please check the list of recommended TRIAC dimmers at page 212.

Personalizable  
Customizable

Certificaciones  
Certifications

Recambios / Spare parts:

R26518PC Difusor / Diffuser

## Descripción lámpara / Lamps description:

230V 50Hz | IP-20 | TRIAC | 8,2 W LED / CRI: 90 / 2700°K | 840 lm fuente de luz / light source

Ref	Acabados / Finishing	Ean13	Euros
2650101248	LED dimable TRIAC - Níquel Satinado Pantalla Cinta Translúcida Blanca LED TRIAC Dimmable - Satin Nickel White Translucent Ribbon Shade	8436047305235	299,00
2650101247	LED dimable TRIAC - Níquel Satinado Pantalla Cinta Translúcida Crema LED TRIAC Dimmable - Satin Nickel Cream Translucent Ribbon Shade	8436047305228	299,00

Familia / Family: BCN

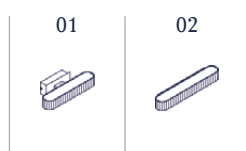

# BCN 02

Diseño / Design:  
Joana Bover / 2012

Tipología: Aplique  
Typology: Wall lamp

Ambiente: Interior  
Environment: Indoor

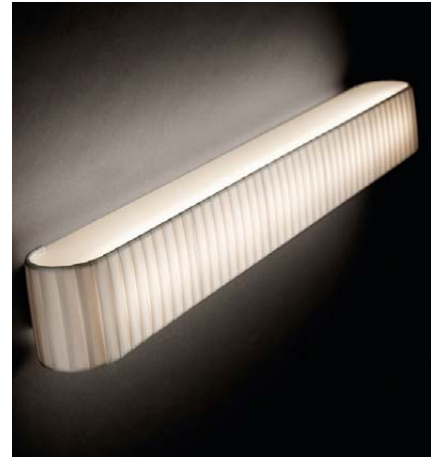
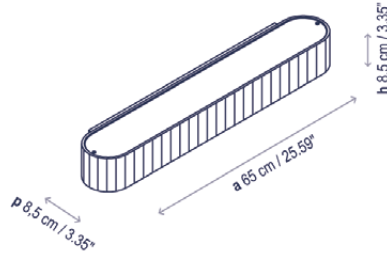

## Descripción técnica / Technical description:

Peso Neto: 1,68 kg  
Net Weight: 1,68 kg

1 Caja/Box | 70 x 24 x 16 cm | 0,0269 m<sup>3</sup>  
Peso bruto / Gross Weight: 2,83 kg

Materiales: Hierro  
Materials: Iron

Difusor superior e inferior: Policarbonato  
Upper and lower diffusers: Polycarbonate

Caja soporte: 57 x 5,5 cm  
Surface back box: 22.44" x 2.17"

Hilo incandescente pantalla: 960°  
Shade GWFI: 960°

Personalizable  
Customizable

Bombillas no incluidas  
Bulbs not included

Certificaciones  
Certifications

Recambios / Spare parts:

R26532PC Difusor / Diffuser

## Descripción lámpara / Lamps description:

230V 50Hz | IP-20 | 11,5 W LED / CRI: 90 / 2700°K | 1400 lm fuente de luz / light source

Ref	Acabados / Finishing	Ean13	Euros
2650201253	LED Dimable TRIAC- Blanco Pantalla Cinta Translúcida Crema LED TRIAC Dimmable - White Cream Translucent Ribbon Shade	8436047307031	400,00
2650201254	LED Dimable TRIAC- Blanco Pantalla Cinta Translúcida Blanca LED TRIAC Dimmable - White White Translucent Ribbon Shade	8436047307994	400,00

Familia / Family: BCN

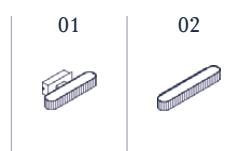

# Beddy A/01

Diseño / Design:  
Danos Salgados / 2018

Tipología: Aplique  
Typology: Wall lamp

Ambiente: Interior  
Environment: Indoor

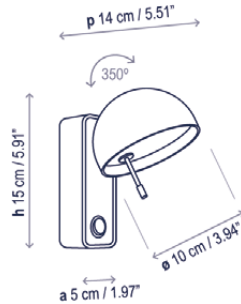

## Descripción técnica / Technical description:

Peso Neto: 0,53 kg  
Net Weight: 0,53 kg

1 Caja/Box | 24 x 22 x 22 cm | 0,0116 m<sup>3</sup>  
Peso bruto / Gross Weight: 1,27 kg

Materiales: Aluminio, Madera  
Materials: Aluminum, Wood

Difusor inferior: Policarbonato  
Lower diffuser: Polycarbonate

Rotación de la pantalla 350°  
Shade rotation 350°

Caja soporte: 5 x 13 cm  
Surface back box: 1.97" x 5.12"

Personalizable: acabado  
Customizable: finishing

Certificaciones  
Certifications

## Descripción lámpara / Lamps description:

100-240V 50/60Hz | IP-20 4,2 W LED / CRI: 90 / 2700°K  
475 lm fuente de luz / light source

Ref	Acabados / Finishing	Ean13	Euros
23601007106	Blanco White	8435493722948	177,00
23601007108	Blanco - Madera Roble White - Oak Wood	8435493722962	191,00

## Familia / Family: Beddy

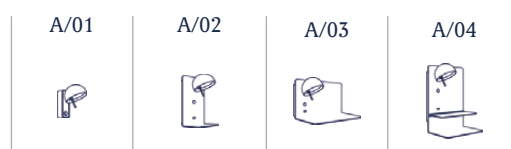

# Beddy A/02

Diseño / Design:  
Danos Salgados / 2018

Tipología: Aplique  
Typology: Wall lamp

Ambiente: Interior  
Environment: Indoor

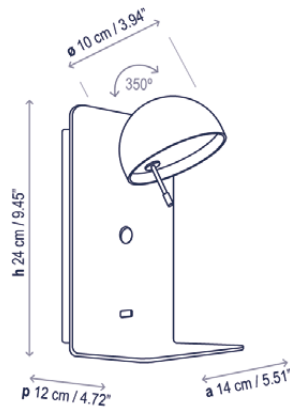

## Descripción técnica / Technical description:

 Peso Neto: 1,15 kg  
Net Weight: 1,15 kg

 1 Caja/Box | 18 x 32 x 18 cm | 0,0104 m<sup>3</sup>  
Peso bruto / Gross Weight: 1,47 kg

Materiales: Aluminio, Hierro  
Materials: Aluminum, Iron

Difusor inferior: Policarbonato  
Lower diffuser: Polycarbonate

Capacidad de carga de la bandeja: 1,5kg.  
Rotación de la pantalla 350°.  
Weight capacity of the tray: 1,5kg.  
Shade rotation 350°.

Caja soporte: 7,5 x 19,5 cm  
Surface back box: 2.95" x 7.68"

USB: 5V  1A

Personalizable  
Customizable

Certificaciones  
Certifications  

## Descripción lámpara / Lamps description:

  230V 50Hz | IP-20 |  4,2 W LED / CRI: 90 / 2700°K  
475 lm fuente de luz / light source 

Ref	Acabados / Finishing	Ean13	Euros
23602020106	Blanco White	8435493722986	265,00

## Familia / Family: Beddy

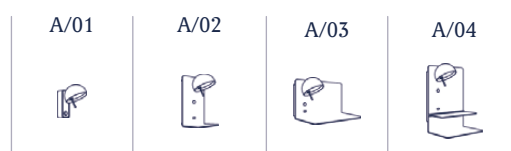

# Beddy A/03

Diseño / Design:  
Danos Salgados / 2018

Tipología: Aplique  
Typology: Wall lamp

Ambiente: Interior  
Environment: Indoor

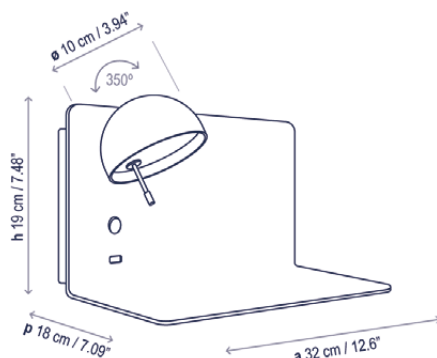

## Descripción técnica / Technical description:

Peso Neto: 1,97 kg  
Net Weight: 1,97 kg

Caja producto individual  
Single product box  
28 x 28 x 41 cm | 0,0321 m<sup>3</sup>  
Peso bruto / Gross Weight: 2,75 kg

Caja Pack 2 unidades  
Pack 2 units box  
31 x 108 x 31 cm | 0,1038 m<sup>3</sup>  
Peso bruto / Gross Weight: 7 kg

Materiales: Aluminio, Hierro  
Materials: Aluminum, Iron

Difusor inferior: Policarbonato  
Lower diffuser: Polycarbonate

Capacidad de carga de la bandeja: 2kg.  
Rotación de la pantalla 350°.  
Weight capacity of the tray: 2kg.  
Shade rotation 350°.

Caja soporte: 26 x 15 cm  
Surface back box: 10.24" x 5.91"

USB: 5V 1A

Personalizable  
Customizable

Certificaciones  
Certifications

## Descripción lámpara / Lamps description:

230V 50Hz | IP-20 | 4,2 W LED / CRI: 90 / 2700°K  
475 lm fuente de luz / light source

Ref	Acabados / Finishing	Ean13	Euros
23603020106	Blanco - Izquierda White - Left	8435493723006	305,00
23604020106	Blanco - Derecha White - Right	8435493723020	305,00
23607020106	Blanco - Pack 2 uds: Izquierda + Derecha White - Pack 2 units: Left + Right	8435493723679	610,00

## Familia / Family: Beddy

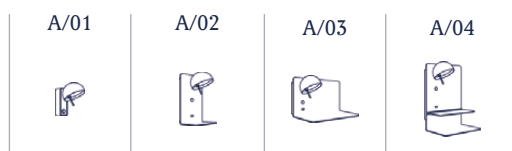

# Beddy A/04

Diseño / Design:  
Danos Salgados / 2018

Tipología: Aplique  
Typology: Wall lamp

Ambiente: Interior  
Environment: Indoor

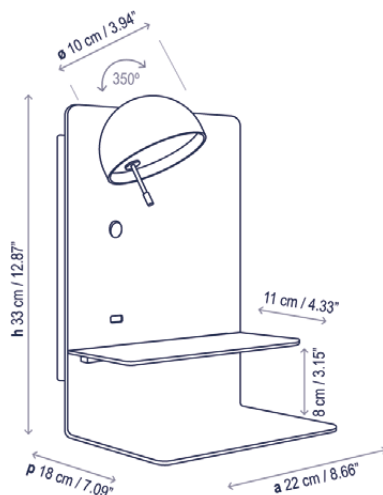

## Descripción técnica / Technical description:

Peso Neto: 2,21 kg  
Net Weight: 2,21 kg

Caja producto individual  
Single product box  
28 x 28 x 41 cm | 0,0321 m<sup>3</sup>  
Peso bruto / Gross Weight: 2,99 kg

Caja Pack 2 unidades  
Pack 2 units box  
31 x 108 x 31 cm | 0,1038 m<sup>3</sup>  
Peso bruto / Gross Weight: 7,5 kg

Materiales: Aluminio, Hierro  
Materials: Aluminum, Iron

Difusor inferior: Policarbonato  
Lower diffuser: Polycarbonate

Capacidad de carga de la bandeja: 2kg.  
Rotación de la pantalla 350°.  
Weight capacity of the tray: 2kg.  
Shade rotation 350°.

Caja soporte: 16 x 24,5 cm  
Surface back box: 6.3" x 9.65"

USB: 5V 1A

Personalizable  
Customizable

Certificaciones  
Certifications

## Descripción lámpara / Lamps description:

230V 50Hz IP-20 4,2 W LED / CRI: 90 / 2700°K  
475 lm fuente de luz / light source

Ref	Acabados / Finishing	Ean13	Euros
23605020106	Blanco - Izquierda White - Left	8435493723044	371,00
23606020106	Blanco - Derecha White - Right	8435493723068	371,00
23608020106	Blanco - Pack 2 uds: Izquierda + Derecha White - Pack 2 units: Left + Right	8435493723693	742,00

## Familia / Family: Beddy

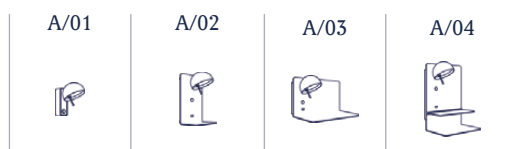

# Carlota G

Diseño / Design:  
Joana Bover / 2003

Tipología: Aplique  
Typology: Wall lamp

Ambiente: Interior  
Environment: Indoor

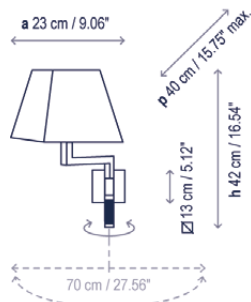

## Descripción técnica / Technical description:

Peso Neto: 1,29 kg  
Net Weight: 1,29 kg

1 Caja/Box | 47 x 47 x 37 cm | 0,0817 m<sup>3</sup>  
Peso bruto / Gross Weight: 3,35 kg

Materiales: Hierro, Latón  
Materials: Iron, Brass

Caja soporte: 11 x 11 cm  
Surface back box: 4.33" x 4.33"

Hilo incandescente pantalla / Shade GWF1

Cinta / Ribbon: 960°  
Cotonet / Cotton: 750°

Personalizable  
Customizable

Bombillas no incluidas  
Bulbs not included

Certificaciones  
Certifications

## Descripción lámpara / Lamps description:

230V 50Hz | IP-20 | 1 x 46 W EcoClassic P45 E-27 | 1 x 11 W CFL E-27 | 1 x 6 W LED P45 E-27

Ref	Acabados / Finishing	Ean13	Euros
1524060/P486	Níquel Piel Oscura Pantalla Cinta Translúcida Blanca Nickel Dark Leather White Translucent Ribbon Shade	8435493703275	306,00
1524060/P489	Níquel Piel Oscura Pantalla Cinta Translúcida Crema Nickel Dark Leather Cream Translucent Ribbon Shade	8435493703299	306,00
1524060/P487	Níquel Piel Oscura Pantalla Cotonet Nickel Dark Leather - White Cotton Shade	8435493703282	292,00
1524005/P486	Níquel Satinado Pantalla Cinta Translúcida Blanca Satin Nickel - White Translucent Ribbon Shade	8435493703213	300,00
1524005/P489	Níquel Satinado Pantalla Cinta Translúcida Crema Satin Nickel - Cream Translucent Ribbon Shade	8435493703237	300,00
1524005/P487	Níquel Satinado Pantalla Cotonet Satin Nickel - White Cotton Shade	8435493703220	286,00

Familia / Family: Carlota

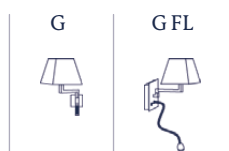

# Carlota G FL

Diseño / Design:  
Joana Bover / 2003

Tipología: Aplique  
Typology: Wall lamp

Ambiente: Interior  
Environment: Indoor

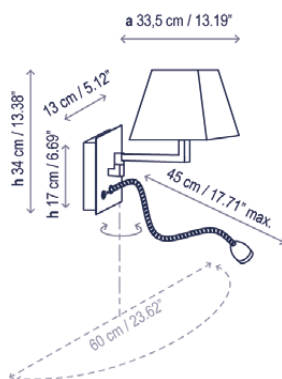

## Descripción técnica / Technical description:

Peso Neto: 1,55 kg  
Net Weight: 1,55 kg

1 Caja/Box | 47 x 47 x 37 cm | 0,0817 m<sup>3</sup>  
Peso bruto / Gross Weight: 3,63 kg

Materiales: Hierro, Latón  
Materials: Iron, Brass

Caja soporte: 13 x 15 cm  
Surface back box: 5.12" x 5.91"

Hilo incandescente pantalla / Shade GWFI

Cinta / Ribbon: 960°  
Cotonet / Cotton: 750°

Personalizable  
Customizable

Bombillas no incluidas  
Bulbs not included

Certificaciones  
Certifications

## Descripción lámpara / Lamps description:

230V 50Hz IP-20 1 x 46 W EcoClassic P45 E-27 1 x 11 W CFL E-27 1 x 6 W LED P45 E-27

1,2 W LED / CRI: 90 / 2700°K  
85 lm fuente de luz / light source

Ref	Acabados / Finishing	Ean13	Euros
F524060/P486	Níquel Piel Oscura Pantalla Cinta Translúcida Blanca Nickel Dark Leather White Translucent Ribbon Shade	8435493714318	456,00
F524060/P489	Níquel Piel Oscura Pantalla Cinta Translúcida Crema Nickel Dark Leather Cream Translucent Ribbon Shade	8435493714332	456,00
F524060/P487	Níquel Piel Oscura Pantalla Cotonet Nickel Dark Leather - White Cotton Shade	8435493714325	441,00
F524005/P486	Níquel Satinado Pantalla Cinta Translúcida Blanca Satin Nickel - White Translucent Ribbon Shade	8435493714257	440,00
F524005/P489	Níquel Satinado Pantalla Cinta Translúcida Crema Satin Nickel - Cream Translucent Ribbon Shade	8435493714271	440,00
F524005/P487	Níquel Satinado Pantalla Cotonet Satin Nickel - White Cotton Shade	8435493714264	425,00

Familia / Family: Carlota

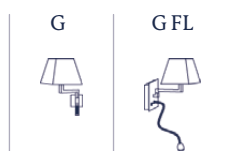



# Cornet A/01 Outdoor

Diseño / Design:  
Alex Fernández Camps / 2017

Tipología: Aplique  
Typology: Wall Lamp

Ambiente: Exterior  
Environment: Outdoor

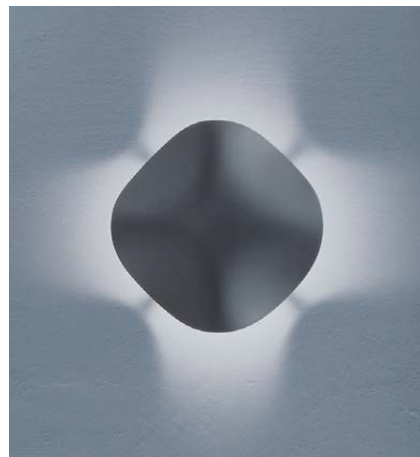
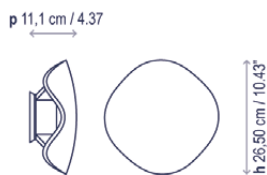

## Descripción técnica / Technical description:

Peso Neto: 1,45 kg  
Net Weight: 1,45 kg

1 Caja/Box | 29 x 29 x 22 cm | 0,0185 m<sup>3</sup>  
Peso bruto / Gross Weight: 1,99 kg

Materiales: Poliuretano, Acero inoxidable 316, Aluminio.  
Materials: Polyurethane, 316 Stainless steel, Aluminum.

Estructuras de metal acabado anodizado plata.  
Metal surfaces silver anodized.

Hilo incandescente: 960°  
GWFI: 960°

Caja soporte: ø 13 cm  
Surface back box: ø 5.12"

Consulte la tabla de reguladores TRIAC recomendados en la página 212.  
Please check the list of recommended TRIAC dimmers at page 212.

Personalizable: acabado  
Customizable: finishing

Certificaciones  
Certifications

## Descripción lámpara / Lamps description:

230V 50HZ | IP-66 | TRIAC | 8 W LED / CRI: 90 / 2700°K | 860 lm fuente de luz / light source

Ref	Acabados / Finishing	Ean13	Euros
3400101227	Regulable Triac - Gris Piedra Dimmable Triac - Stone Grey	8436544896236	286,00

Familia / Family: Cornet



# Cornet B/27 Outdoor

Diseño / Design:  
Alex Fernández Camps / 2017

Tipología: Baliza  
Typology: Bollard

Ambiente: Exterior  
Environment: Outdoor

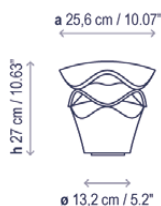

## Descripción técnica / Technical description:

Peso Neto: 3,31 kg  
Net Weight: 3,31 kg

1 Caja/Box | 38 x 38 x 41 cm | 0,0592 m<sup>3</sup>  
Peso bruto / Gross Weight: 5,05 kg

Materiales: Poliuretano, Acero inoxidable 316, Aluminio.  
Materials: Polyurethane, 316 Stainless steel, Aluminum.

Estructuras de metal acabado anodizado plata.  
Metal surfaces silver anodized.

Baliza con dos opciones de sujeción:  
1. Fijación a suelo, tornillería y tacos no incluidos.  
2. Fijación por cimentación, accesorio de anclaje no incluido.

Two anchoring options:  
1. Anchoring to ground, screws and anchors not included.  
2. Anchoring for foundation, fasteners accessories not included.

Hilo incandescente: 960°  
GWFI: 960°

Consulte la tabla de reguladores TRIAC recomendados en la página 212.  
Please check the list of recommended TRIAC dimmers at page 212.

Personalizable: acabado  
Customizable: finishing

Certificaciones  
Certifications

Accesorios / Accessories:

R34036 Anclaje / Anchorage

## Descripción lámpara / Lamps description:

230V 50Hz | IP-66 | IK 8 | TRIAC 8 W LED / CRI: 90 / 2700°K | 860 lm fuente de luz / light source

Ref	Acabados / Finishing	Ean13	Euros
3400240027	Regulable Triac - Gris Piedra Dimmable Triac - Stone Grey	8436544896243	602,00

Familia / Family: Cornet



# Cornet B/52 Outdoor

Diseño / Design:  
Alex Fernández Camps / 2017

Tipología: Baliza  
Typology: Bollard

Ambiente: Exterior  
Environment: Outdoor

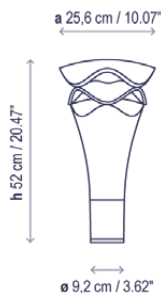

## Descripción técnica / Technical description:

Peso Neto: 5,1 kg  
Net Weight: 5,1 kg

1 Caja/Box | 38 x 63 x 42 cm | 0,1005 m<sup>3</sup>  
Peso bruto / Gross Weight: 7,45 kg

Materiales: Poliuretano, Acero inoxidable 316, Aluminio.  
Materials: Polyurethane, 316 Stainless steel, Aluminum.

Estructuras de metal acabado anodizado plata.  
Metal surfaces silver anodized.

Baliza con dos opciones de sujeción:  
1. Fijación a suelo, tornillería y tacos no incluidos.  
2. Fijación por cimentación, accesorio de anclaje no incluido.

Two anchoring options:  
1. Anchoring to ground, screws and anchors not included.  
2. Anchoring for foundation, fasteners accessories not included.

Hilo incandescente: 960°  
GWFI: 960°

Consulte la tabla de reguladores TRIAC recomendados en la página 212.  
Please check the list of recommended TRIAC dimmers at page 212.

Personalizable: acabado  
Customizable: finishing

Certificaciones  
Certifications

Accesorios / Accessories:

R34036 Anclaje / Anchorage

## Descripción lámpara / Lamps description:

230V 50Hz | IP-66 | IK 8 | 8 W LED / CRI: 90 / 2700°K | 860 lm fuente de luz / light source

Ref	Acabados / Finishing	Ean13	Euros
3400340027	Regulable Triac - Gris Piedra Dimmable Triac - Stone Grey	8436544896250	670,00

Familia / Family: Cornet



# Cornet B/77 Outdoor

Diseño / Design:  
Alex Fernández Camps / 2017

Tipología: Baliza  
Typology: Bollard

Ambiente: Exterior  
Environment: Outdoor

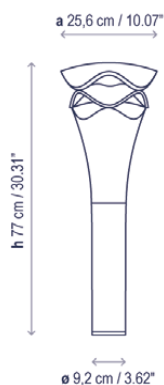

## Descripción técnica / Technical description:

Peso Neto: 5,75 kg  
Net Weight: 5,75 kg

1 Caja/Box | 39 x 88 x 43 cm | 0,1476 m<sup>3</sup>  
Peso bruto / Gross Weight: 8,7 kg

Materiales: Poliuretano, Acero inoxidable 316, Aluminio.  
Materials: Polyurethane, 316 Stainless steel, Aluminum.

Estructuras de metal acabado anodizado plata.  
Metal surfaces silver anodized.

Baliza con dos opciones de sujeción:  
1. Fijación a suelo, tornillería y tacos no incluidos.  
2. Fijación por cimentación, accesorio de anclaje no incluido.

Two anchoring options:  
1. Anchoring to ground, screws and anchors not included.  
2. Anchoring for foundation, fasteners accessories not included.

Hilo incandescente: 960°  
GWFI: 960°

Consulte la tabla de reguladores TRIAC recomendados en la página 212.  
Please check the list of recommended TRIAC dimmers at page 212.

Personalizable: acabado  
Customizable: finishing

Certificaciones  
Certifications

Accesorios / Accessories:

R34036 Anclaje / Anchorage

## Descripción lámpara / Lamps description:

230V 50Hz | IP-66 | IK 8 | 8 W LED / CRI: 90 / 2700°K | 860 lm fuente de luz / light source

Ref	Acabados / Finishing	Ean13	Euros
3400440027	Regulable Triac - Gris Piedra Dimmable Triac - Stone Grey	8436544896267	706,00

Familia / Family: Cornet



# Danona 3L

Diseño / Design:  
Joana Bover / 2002

Tipología: Suspensión  
Typology: Pendant lamp

Ambiente: Interior  
Environment: Indoor

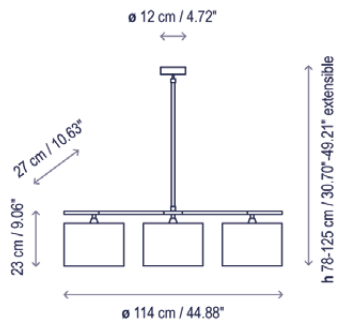

## Descripción técnica / Technical description:

Peso Neto: 2,88 kg  
Net Weight: 2,88 kg

1 Caja/Box | 117 x 43 x 43 cm | 0,2163 m<sup>3</sup>  
Peso bruto / Gross Weight: 7,44 kg

Materiales: Hierro, Piel  
Materials: Iron, Leather

Hilo incandescente pantalla / Shade GWF1

Cinta / Ribbon: 960°  
Cotonet / Cotton: 750°

Personalizable  
Customizable

Bombillas no incluidas  
Bulbs not included

Certificaciones  
Certifications

## Descripción lámpara / Lamps description:

230V 50Hz IP-20 3 x 77 W EcoClass A55 E-27 3 x 18 W CFL E-27 3 x 9 W LED A60 E-27

Ref	Acabados / Finishing	Ean13	Euros
4323105/P006C	Níquel - Pantalla Cinta Translúcida Blanca Nickel - White Translucent Ribbon Shade	8435493711959	492,00
4323105/P005C	Níquel - Pantalla Cinta Translúcida Crema Nickel - Cream Translucent Ribbon Shade	8435493711942	492,00
4323105/P150	Níquel - Pantalla Cotonet Nickel - White Cotton Shade	8435493711966	395,00
4323160/P006C	Níquel Piel Oscura Pantalla Cinta Translúcida Blanca Nickel Dark Leather White Translucent Ribbon Shade	8435493711980	547,00
4323160/P005C	Níquel Piel Oscura Pantalla Cinta Translúcida Crema Nickel Dark Leather Cream Translucent Ribbon Shade	8435493711973	547,00
4323160/P150	Níquel Piel Oscura Pantalla Cotonet Nickel Dark Leather - White Cotton Shade	8435493711997	451,00

Familia / Family: Danona

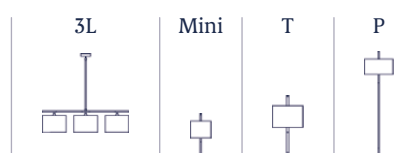

# Danona Mini

Diseño / Design:  
Joana Bover / 2002

Tipología: Mesa  
Typology: Table lamp

Ambiente: Interior  
Environment: Indoor

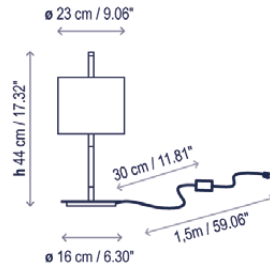

## Descripción técnica / Technical description:

Peso Neto: 1,16 kg  
Net Weight: 1,16 kg

1 Caja/Box | 47 x 47 x 37 cm | 0,0817 m<sup>3</sup>  
Peso bruto / Gross Weight: 3,11 kg

Materiales: Hierro, Piel  
Materials: Iron, Leather

Difusor superior: Metacrilato  
Upper diffuser: Methacrylate

Cable eléctrico negro  
Black electrical cable

Hilo incandescente pantalla / Shade GWF1

Cinta / Ribbon: 960°  
Cotonet / Cotton: 750°

Personalizable  
Customizable

Bombillas no incluidas  
Bulbs not included

Certificaciones  
Certifications

Recambios / Spare parts:

R20231DIF Difusor / Diffuser

## Descripción lámpara / Lamps description:

230V 50HZ | IP-20 | 1 x 46 W EcoClassic P45 E-27 | 1 x 6 W LED P45 E-27

Ref	Acabados / Finishing	Ean13	Euros
2023105/P004	Níquel - Pantalla Cinta Translúcida Blanca Nickel - White Translucent Ribbon Shade	8435493703725	181,00
2023105/P003	Níquel - Pantalla Cinta Translúcida Crema Nickel - Cream Translucent Ribbon Shade	8435493703718	181,00
2023105/P230	Níquel - Pantalla Cotonet Nickel - White Cotton Shade	8435493703732	170,00
2023160/P004	Níquel Piel Oscura Pantalla Cinta Translúcida Blanca Nickel Dark Leather White Translucent Ribbon Shade	8435493703756	187,00
2023160/P003	Níquel Piel Oscura Pantalla Cinta Translúcida Crema Nickel Dark Leather Cream Translucent Ribbon Shade	8435493703749	187,00
2023160/P230	Níquel Piel Oscura Pantalla Cotonet Nickel Dark Leather - White Cotton Shade	8435493703763	177,00

Familia / Family: Danona

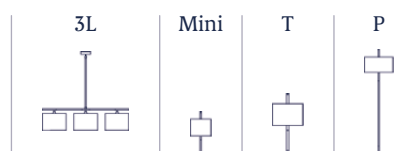

# Danona T

Diseño / Design:  
Joana Bover / 2002

Tipología: Mesa  
Typology: Table lamp

Ambiente: Interior  
Environment: Indoor

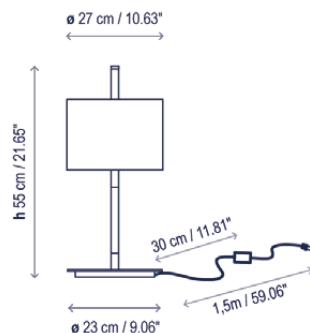

## Descripción técnica / Technical description:

Peso Neto: 2,13 kg  
Net Weight: 2,13 kg

1 Caja/Box | 61 x 61 x 40 cm | 0,1488 m<sup>3</sup>  
Peso bruto / Gross Weight: 5,06 kg

Materiales: Hierro, Piel  
Materials: Iron, Leather

Difusor superior: Metacrilato  
Upper diffuser: Methacrylate

Cable eléctrico negro  
Black electrical cable

Hilo incandescente pantalla / Shade GWF I

Cinta / Ribbon: 960°  
Cotonet / Cotton: 750°

Personalizable  
Customizable

Bombillas no incluidas  
Bulbs not included

Certificaciones  
Certifications

Recambios / Spare parts:

R21231DIF Difusor / Diffuser

## Descripción lámpara / Lamps description:

230V 50Hz | IP-20 | 1 x 46 W EcoClassic P45 E-27 | 1 x 11 W CFL E-27 | 1 x 6 W LED P45 E-27

Ref	Acabados / Finishing	Ean13	Euros
2123105/P006	Níquel - Pantalla Cinta Translúcida Blanca Nickel - White Translucent Ribbon Shade	8435493704333	232,00
2123105/P005	Níquel - Pantalla Cinta Translúcida Crema Nickel - Cream Translucent Ribbon Shade	8435493704326	232,00
2123105/P227	Níquel - Pantalla Cotonet Nickel - White Cotton Shade	8435493704340	206,00
2123160/P006	Níquel Piel Oscura Pantalla Cinta Translúcida Blanca Nickel Dark Leather White Translucent Ribbon Shade	8435493704364	240,00
2123160/P005	Níquel Piel Oscura Pantalla Cinta Translúcida Crema Nickel Dark Leather Cream Translucent Ribbon Shade	8435493704357	240,00
2123160/P227	Níquel Piel Oscura Pantalla Cotonet Nickel Dark Leather - White Cotton Shade	8435493704371	219,00

Familia / Family: Danona

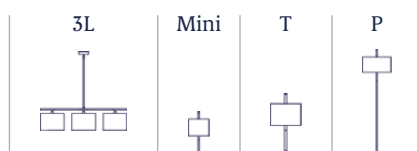



# Danona P

Diseño / Design:  
Joana Bover / 2002

Tipología: Pie  
Typology: Floor lamp

Ambiente: Interior  
Environment: Indoor

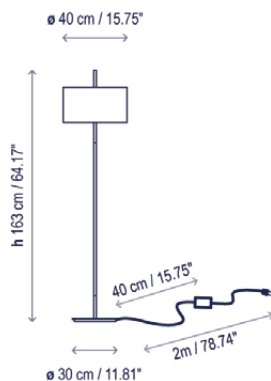

## Descripción técnica / Technical description:

Peso Neto: 4,3 kg  
Net Weight: 4,3 kg

2 Cajas / 2 Boxes:

1 Caja/Box | 32 x 31 x 165 cm | 0,1637 m<sup>3</sup>  
Peso bruto / Gross Weight: 7,48 kg

1 Caja/Box | 28 x 45 x 45 cm | 0,0567 m<sup>3</sup>  
Peso bruto / Gross Weight: 1,71 kg

Materiales: Hierro, Piel  
Materials: Iron, Leather

Difusor superior: Metacrilato  
Upper diffuser: Methacrylate

Cable eléctrico negro  
Black electrical cable

Hilo incandescente pantalla / Shade GWF1

Cinta / Ribbon: 960°  
Cotonet / Cotton: 750°

Personalizable  
Customizable

Bombillas no incluidas  
Bulbs not included

Certificaciones  
Certifications

Recambios / Spare parts:

R30231DIF Difusor / Diffuser

## Descripción lámpara / Lamps description:

230V 50HZ | IP-20 | 2 x 46 W EcoClassic P45 E-27 | 2 x 11 W CFL E-27 | 2 x 6 W LED P45 E-27

Ref	Acabados / Finishing	Ean13	Euros
3023105/P137	Níquel - Pantalla Cinta Translúcida Blanca Nickel - White Translucent Ribbon Shade	8435493707433	460,00
3023105/P138	Níquel - Pantalla Cinta Translúcida Crema Nickel - Cream Translucent Ribbon Shade	8435493707440	460,00
3023105/P133	Níquel - Pantalla Cotonet Nickel - White Cotton Shade	8435493707426	427,00
3023160/P137	Níquel Piel Oscura Pantalla Cinta Translúcida Blanca Nickel Dark Leather White Translucent Ribbon Shade	8435493707464	467,00
3023160/P138	Níquel Piel Oscura Pantalla Cinta Translúcida Crema Nickel Dark Leather Cream Translucent Ribbon Shade	8435493707471	467,00
3023160/P133	Níquel Piel Oscura Pantalla Cotonet Nickel Dark Leather - White Cotton Shade	8435493707457	438,00

## Familia / Family: Danona

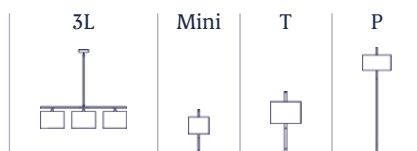



# Dome 60/01

Diseño / Design:

Benedetta Tagliabue | EMBT / 2015

Tipología: Suspensión

Typology: Pendant lamp

Ambiente: Interior

Environment: Indoor

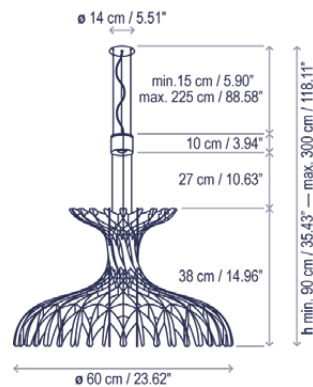

## Descripción técnica / Technical description:

 Peso Neto: 2,38 kg  
Net Weight: 2,38 kg

 1 Caja/Box | 67 x 67 x 57 cm | 0,2559 m<sup>3</sup>  
Peso bruto / Gross Weight: 4,63 kg

Materiales: Hierro, Aluminio, Madera  
acabado haya.

Materials: Iron, Aluminum, Wood finished  
beech.

La fuente de luz está situada sobre la  
estructura, proyectando bellos mosaicos de  
luz en las superficies inferiores.

The light is above the structure to illuminate  
throughout the open and diffused portions  
casting beautiful shadow patterns on surfaces  
below.

Consulte la tabla de reguladores TRIAC  
recomendados en la página 212.

Please check the list of recommended TRIAC  
dimmers at page 212.

No personalizable

Not customizable

Certificaciones  
Certifications



## Descripción lámpara / Lamps description:

  230V  
50Hz | IP-20 |   12,5 W LED / CRI: 90 / 2700<sup>o</sup>K  
1352 lm fuente de luz / light source

Ref	Acabados / Finishing	Ean13	Euros
2580621400/P829	Regulable Triac - Blanco Mate Pantalla Madera Natural Dimmable Triac - Matte White Natural Wood Shade	8435493705897	1.046,00

## Familia / Family: Dome

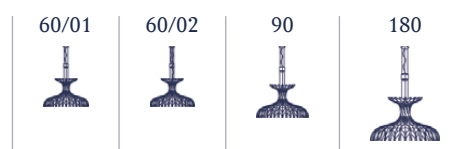

# Dome 60/02

Diseño / Design:

Benedetta Tagliabue | EMBT / 2015

Tipología: Suspensión

Typology: Pendant lamp

Ambiente: Interior

Environment: Indoor

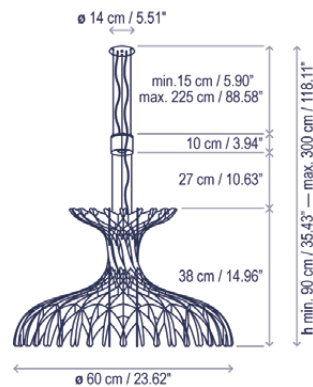

## Descripción técnica / Technical description:

Peso Neto: 2,76 kg  
Net Weight: 2,76 kg

1 Caja/Box | 67 x 67 x 57 cm | 0,2559 m<sup>3</sup>  
Peso bruto / Gross Weight: 5 kg

Materiales: Hierro, Aluminio, Madera acabado haya.

Materials: Iron, Aluminum, Wood finished beech.

La fuente de luz está situada sobre la estructura, proyectando bellos mosaicos de luz en las superficies inferiores.

The light is above the structure to illuminate throughout the open and diffused portions casting beautiful shadow patterns on surfaces below.

La fuente de luz adicional de la Dome 60/02 proporciona luz directa a la superficie inferior, el LED ubicado sobre la pantalla ofrece luz de ambiente.

The additional LED source on the Dome 60/02 allows for more focused illumination on surfaces below, while the upper light provides for ambient light.

Consulte la tabla de reguladores TRIAC recomendados en la página 212.

Please check the list of recommended TRIAC dimmers at page 212.

No personalizable

Not customizable

Certificaciones  
Certifications



## Descripción lámpara / Lamps description:

230V 50HZ IP-20 25 W LED / CRI: 90 / 2700°K  
2664 lm fuente de luz / light source

Ref	Acabados / Finishing	Ean13	Euros
2580721400/P829	Regulable Triac - Blanco Mate Pantalla Madera Natural Dimmable Triac - Matte White Natural Wood Shade	8435493714707	1.206,00

## Familia / Family: Dome

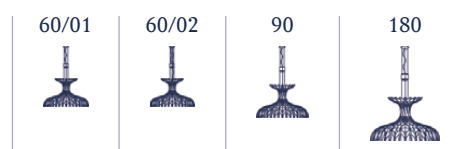

# Dome 90

Diseño / Design:

Benedetta Tagliabue | EMBT / 2015

Tipología: Suspensión

Typology: Pendant lamp

Ambiente: Interior

Environment: Indoor

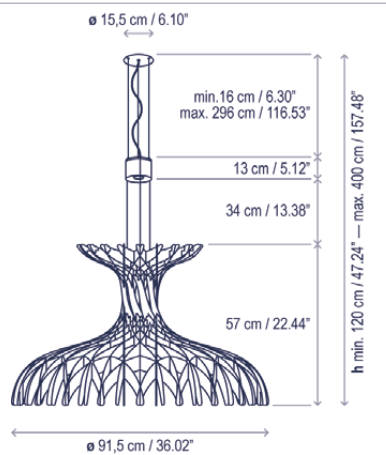

## Descripción técnica / Technical description:

Peso Neto: 8,2 kg  
Net Weight: 8,2 kg

1 Caja/Box | 115 x 100 x 100 cm | 1,15 m<sup>3</sup>  
Peso bruto / Gross Weight: 32 kg

Materiales: Hierro, Aluminio, Madera  
acabado haya.

Materials: Iron, Aluminum, Wood finished  
beech.

La fuente de luz está situada sobre la  
estructura, proyectando bellos mosaicos de  
luz en las superficies inferiores.

The light is above the structure to illuminate  
throughout the open and diffused portions  
casting beautiful shadow patterns on surfaces  
below.

Consulte la tabla de reguladores TRIAC  
recomendados en la página 212.

Please check the list of recommended TRIAC  
dimmers at page 212.

No personalizable

Not customizable

Certificaciones  
Certifications



## Descripción lámpara / Lamps description:

230V  
50Hz | IP-20 | TRIAC | 25 W LED / CRI: 82 / 2700°K  
2750 lm fuente de luz / light source



Ref	Acabados / Finishing	Ean13	Euros
2580921400/P811	Regulable Triac - Blanco Mate Pantalla Madera Natural Dimmable Triac - Matte White Natural Wood Shade	8435493705910	2.352,00

## Familia / Family: Dome

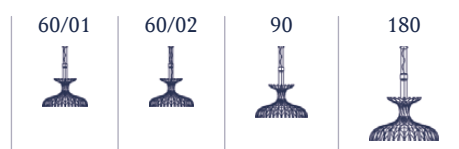

# Dome 180

Diseño / Design:  
Benedetta Tagliabue | EMBT / 2015

Tipología: Suspensión  
Typology: Pendant lamp

Ambiente: Interior  
Environment: Indoor

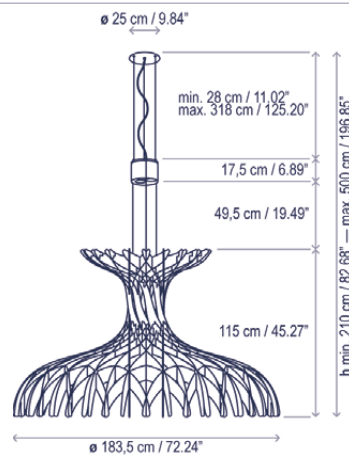

## Descripción técnica / Technical description:

Peso Neto: 49,25 kg  
Net Weight: 49,25 kg

1 Caja/Box | 165 x 130 x 130 cm | 2,7885 m<sup>3</sup>  
Peso bruto / Gross Weight: 97,02 kg

Materiales: Hierro, Aluminio, Madera  
acabado haya.

Materials: Iron, Aluminum, Wood finished  
beech.

La fuente de luz está situada sobre la  
estructura, proyectando bellos mosaicos de  
luz en las superficies inferiores.

The light is above the structure to illuminate  
throughout the open and diffused portions  
casting beautiful shadow patterns on surfaces  
below.

Consulte la tabla de reguladores TRIAC  
recomendados en la página 212.  
Please check the list of recommended TRIAC  
dimmers at page 212.

No personalizable  
Not customizable

Certificaciones  
Certifications

## Descripción lámpara / Lamps description:

230V  
50Hz IP-20 75 W LED / CRI: 82 / 2700°K  
8250 lm fuente de luz / light source

Ref	Acabados / Finishing	Ean13	Euros
2581821400/P812	Regulable Triac - Blanco Mate Pantalla Madera Natural Dimmable Triac - Matte White Natural Wood Shade	8435493705934	8.954,00

## Familia / Family: Dome

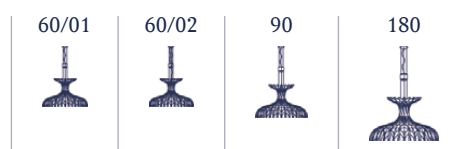

# Domita S/20

Diseño / Design:

Benedetta Tagliabue | Joana Bover / 2019

Tipología: Suspensión

Typology: Pendant lamp

Ambiente: Interior

Environment: Indoor

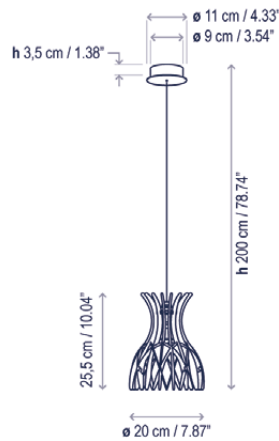

## Descripción técnica / Technical description:

Peso Neto: 0,71 kg  
Net Weight: 0,71 kg

1 Caja/Box | 28 x 28 x 41 cm | 0,0321 m<sup>3</sup>  
Peso bruto / Gross Weight: 1,5 kg

Materiales: Hierro, Aluminio, Madera  
acabado haya.

Materials: Iron, Aluminum, Wood finished  
beech.

Cable eléctrico TPE de color negro  
TPE black cable

Personalizable: acabado  
Customizable: finishing

Regulable TRIAC solo si se utilizan bombillas  
regulables.  
Dimmable TRIAC only if dimmable bulbs are used

Bombillas no incluidas  
Bulbs not included

Certificaciones  
Certifications

Recambios / Spare parts::

RSUB258922114 Pantalla madera / Wood shade

## Descripción lámpara / Lamps description:

230V  
50Hz | IP-20 | 1 x 8 W LED GU10

Ref	Acabados / Finishing	Ean13	Euros
25802200114	Marrón - Madera Natural Brown - Natural Wood	8435493723976	269,00

## Familia / Family: Domita



# Domita S/20/3L

Diseño / Design:

Benedetta Tagliabue | Joana Bover / 2019

Tipología: Suspensión

Typology: Pendant lamp

Ambiente: Interior

Environment: Indoor

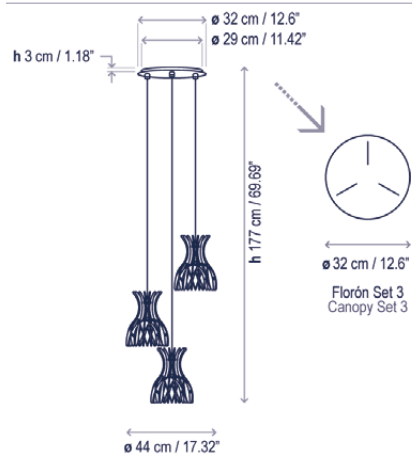
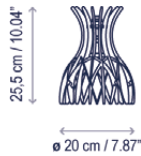

## Descripción técnica / Technical description:

Peso Neto: 3,23 kg  
Net Weight: 3,23 kg

1 Caja/Box | 61 x 61 x 39 cm | 0,1451 m<sup>3</sup>  
Peso bruto / Gross Weight: 8,1 kg

Materiales: Hierro, Aluminio, Madera acabado haya.

Materials: Iron, Aluminum, Wood finished beech.

Florón estándar: las ranuras en el florón permiten ajustar la posición de las luminarias durante la instalación.

Standard canopy: canopy features slots for the cable connection to allow adjustability of the cluster on placement.

Cable eléctrico TPE de color negro  
TPE black cable

Personalizable: acabado  
Customizable: finishing

Regulable TRIAC solo si se utilizan bombillas regulables.  
Dimmable TRIAC only if dimmable bulbs are used

Bombillas no incluidas  
Bulbs not included

Certificaciones  
Certifications

Recambios / Spare parts::

RSUB258922114 Pantalla madera / Wood shade

## Descripción lámpara / Lamps description:

230V 50Hz | IP-20 | 3 x 8 W LED GU10

Ref	Acabados / Finishing	Ean13	Euros
25812200114	Marrón - Madera Natural Brown - Natural Wood	8435493724348	653,00

## Familia / Family: Domita





# Domita S/20/4L

Diseño / Design:  
Benedetta Tagliabue | Joana Bover / 2019

Tipología: Suspensión  
Typology: Pendant lamp

Ambiente: Interior  
Environment: Indoor

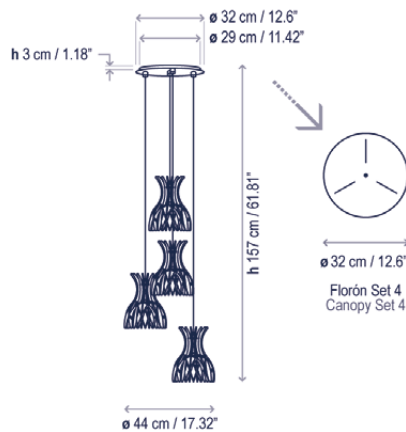
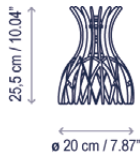

## Descripción técnica / Technical description:

Peso Neto: 3,7 kg  
Net Weight: 3,7 kg

1 Caja/Box | 61 x 61 x 51 cm | 0,1898 m<sup>3</sup>  
Peso bruto / Gross Weight: 9 kg

Materiales: Hierro, Aluminio, Madera  
acabado haya.

Materials: Iron, Aluminum, Wood finished  
beech.

Florón estándar: las ranuras en el florón  
permiten ajustar la posición de las luminarias  
durante la instalación.

Standard canopy: canopy features slots for the  
cable connection to allow adjustability of the  
cluster on placement.

Florón múltiple: permite instalar la luminaria  
en la posición deseada a través de suspensores  
que sujetan y dirigen el cable eléctrico.

Multiple canopy: This allows installing the  
lights in desired positions through suspenders  
that hold and direct the electrical cable.

Cable eléctrico TPE de color negro  
TPE black cable

Personalizable: acabado y medidas cable  
Customizable: finishing and cable length

Regulable TRIAC solo si se utilizan bombillas  
regulables.

Dimmable TRIAC only if dimmable bulbs are used

Bombillas no incluidas  
Bulbs not included

Certificaciones  
Certifications

Recambios / Spare parts::

RSUB258922114 Pantalla madera / Wood shade  
R25861671 Soporte cable / Cable support

## Descripción lámpara florón estándar / Lamps description standard canopy:

230V 50Hz IP-20 4 x 8 W LED GU10

Ref	Acabados / Finishing	Ean13	Euros
25822200114	Marrón - Madera Natural Brown - Natural Wood	8435493723730	842,00

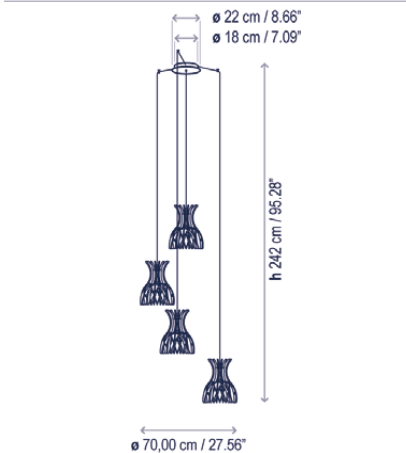

## Descripción lámpara florón múltiple / Lamps description multiple canopy:

230V 50Hz IP-20 4 x 8 W LED GU10

Ref	Acabados / Finishing	Ean13	Euros
25832200114	Florón Múltiple Marrón - Madera Natural Multiple Canopy Brown - Natural Wood	8435493724218	873,00

Familia / Family: Domita

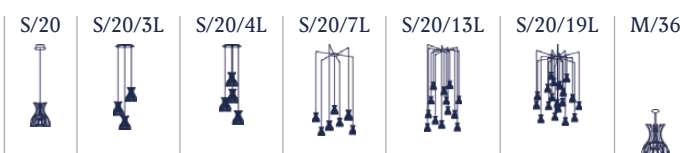

# Domita S/20/7L

Diseño / Design:

Benedetta Tagliabue | Joana Bover / 2019

Tipología: Suspensión

Typology: Pendant lamp

Ambiente: Interior

Environment: Indoor

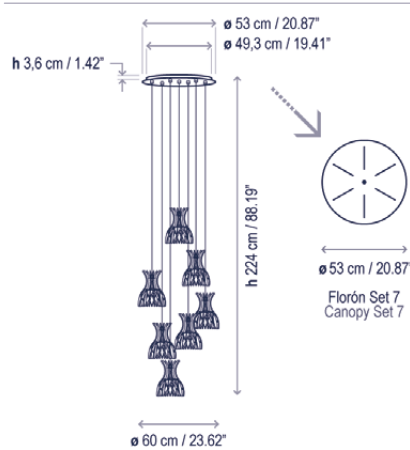
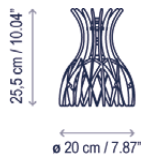

Descripción técnica / Technical description:

Peso Neto: 9,54 kg  
Net Weight: 9,54 kg

1 Caja/Box | 64 x 64 x 83 cm | 0,34 m<sup>3</sup>  
Peso bruto / Gross Weight: 18,53 kg

Materiales: Hierro, Aluminio, Madera  
acabado haya.

Materials: Iron, Aluminum, Wood finished  
beech.

Florón estándar: las ranuras en el florón  
permiten ajustar la posición de las luminarias  
durante la instalación.

Standard canopy: canopy features slots for the  
cable connection to allow adjustability of the  
cluster on placement.

Florón múltiple: permite instalar la luminaria  
en la posición deseada a través de suspensores  
que sujetan y dirigen el cable eléctrico.

Multiple canopy: This allows installing the  
lights in desired positions through suspenders  
that hold and direct the electrical cable.

Cable eléctrico TPE de color negro  
TPE black cable

Personalizable: acabado  
Customizable: finishing

Regulable TRIAC solo si se utilizan bombillas  
regulables.

Dimmable TRIAC only if dimmable bulbs are used

Bombillas no incluidas  
Bulbs not included

Certificaciones  
Certifications

Recambios / Spare parts:

RSUB258922114 Pantalla madera / Wood shade  
R25861671 Soporte cable / Cable support

Descripción lámpara florón estándar / Lamps description standard canopy:

230V 50Hz IP-20 7 x 8 W LED GU10

Ref	Acabados / Finishing	Ean13	Euros
25842200114	Marrón - Madera Natural Brown - Natural Wood	8435493724300	1.522,00

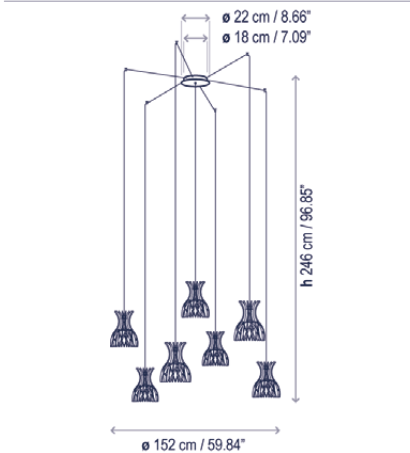

Descripción lámpara florón múltiple / Lamps description multiple canopy:

230V 50Hz IP-20 7 x 8 W LED GU10

Ref	Acabados / Finishing	Ean13	Euros
25852200114	Florón Múltiple Marrón - Madera Natural Multiple Canopy Brown - Natural Wood	8435493724287	1.420,00

Familia / Family: Domita

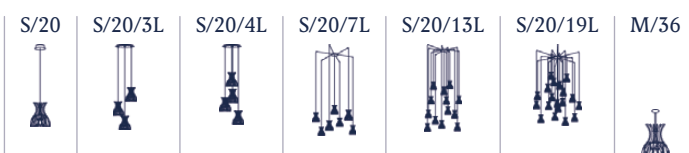



# Domita S/20/13L

Diseño / Design:

Benedetta Tagliabue | Joana Bover / 2019

Tipología: Suspensión

Typology: Pendant lamp

Ambiente: Interior

Environment: Indoor

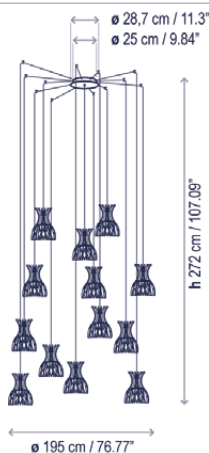
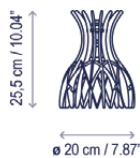

Descripción técnica / Technical description:

Peso Neto: 7,70 kg  
Net Weight: 7,70 kg

1 Caja/Box | 80 x 80 x 83 cm | 0,5312 m<sup>3</sup>  
Peso bruto / Gross Weight: 18,70 kg

Materiales: Hierro, Aluminio, Madera acabado haya.

Materials: Iron, Aluminum, Wood finished beech.

Florón múltiple: permite instalar la luminaria en la posición deseada a través de suspensores que sujetan y dirigen el cable eléctrico.

Multiple canopy: This allows installing the lights in desired positions through suspenders that hold and direct the electrical cable.

Cable eléctrico TPE de color negro  
TPE black cable

Personalizable: acabado  
Customizable: finishing

Regulable TRIAC solo si se utilizan bombillas regulables.  
Dimmable TRIAC only if dimmable bulbs are used

Bombillas no incluidas  
Bulbs not included

Certificaciones  
Certifications

Recambios / Spare parts::

RSUB258922114 Pantalla madera / Wood shade  
R25861671 Soporte cable / Cable support

Descripción lámpara / Lamps description:

230V 50Hz | IP-20 | 13 x 8 W LED GU10

Ref	Acabados / Finishing	Ean13	Euros
25862200114	Florón Múltiple Marrón - Madera Natural Multiple Canopy Brown - Natural Wood	8435493724249	2.466,00

Familia / Family: Domita



# Domita S/20/19L

## Diseño / Design:

Benedetta Tagliabue | Joana Bover / 2019

## Tipología: Suspensión

Typology: Pendant lamp

## Ambiente: Interior

Environment: Indoor

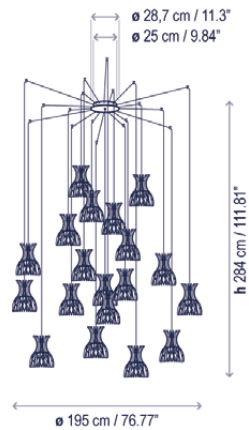
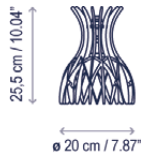

## Descripción técnica / Technical description:

Peso Neto: 8,03 kg  
Net Weight: 8,03 kg

1 Caja/Box | 100 x 100 x 116 cm | 1,16 m<sup>3</sup>  
Peso bruto / Gross Weight: 38 kg

Materiales: Hierro, Aluminio, Madera acabado haya.

Materials: Iron, Aluminum, Wood finished beech.

Florón múltiple: permite instalar la luminaria en la posición deseada a través de suspensores que sujetan y dirigen el cable eléctrico.

Multiple canopy: This allows installing the lights in desired positions through suspenders that hold and direct the electrical cable.

Cable eléctrico TPE de color negro  
TPE black cable

Personalizable: acabado  
Customizable: finishing

Regulable TRIAC solo si se utilizan bombillas regulables.  
Dimmable TRIAC only if dimmable bulbs are used

Bombillas no incluidas  
Bulbs not included

Certificaciones  
Certifications

Recambios / Spare parts::

RSUB258922114 Pantalla madera / Wood shade  
R25861671 Soporte cable / Cable support

## Descripción lámpara / Lamps description:

230V 50Hz IP-20 19 x 8 W LED GU10

Ref	Acabados / Finishing	Ean13	Euros
25872200114	Florón Múltiple Marrón - Madera Natural Multiple Canopy Brown - Natural Wood	8435493724256	3.859,00

## Familia / Family: Domita



# Domita M/36

Diseño / Design:

Benedetta Tagliabue | Joana Bover / 2019

Tipología: Mesa

Typology: Table lamp

Ambiente: Interior

Environment: Indoor

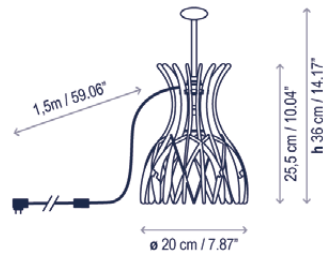

## Descripción técnica / Technical description:

Peso Neto: 0,46 kg  
Net Weight: 0,46 kg

1 Caja/Box | 28 x 28 x 46 cm | 0,036 m<sup>3</sup>  
Peso bruto / Gross Weight: 1,33 kg

Materiales: Hierro, Aluminio, Madera  
acabado haya.

Materials: Iron, Aluminum, Wood finished  
beech.



Interruptor de encendido y enchufe para  
clavija tipo C.

On/Off switch and outlet for type C plug.

Cable negro  
Black cable

Personalizable: acabado  
Customizable: finishing

Bombillas no incluidas  
Bulbs not included

Certificaciones  
Certifications



## Descripción lámpara / Lamps description:

100-240V  
50/60Hz | IP-20 | 1 x 6 W LED GU5.3

Ref	Acabados / Finishing	Ean13	Euros
25802316114	Marrón - Madera Natural Brown - Natural Wood	8435493724195	288,00

## Familia / Family: Domita



# Drip/Drop A/01

Diseño / Design:  
Christophe Mathieu / 2017

Tipología: Aplique  
Typology: Wall Lamp

Ambiente: Interior  
Environment: Indoor

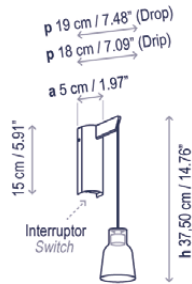

## Descripción técnica / Technical description:

(Drip) Peso Neto / Net Weight: 0,63 kg  
(Drop) Peso Neto / Net Weight: 0,65 kg

1 Caja/Box | 24 x 22 x 22 cm | 0,0116 m<sup>3</sup>  
(Drip) Peso bruto / Gross Weight: 1,06 kg  
(Drop) Peso bruto / Gross Weight: 1,08 kg

Materiales: Aluminio, Hierro,  
Vidrio borosilicato / Polycarbonato  
Materials: Aluminum, Iron,  
Borosilicate glass / Polycarbonate

Acabado estructura color ébano negro  
Structure finish: ebony black

Con interruptor  
With switch

Caja soporte: 5 x 15 cm  
Surface back box: 1.97" x 5.91"

Cable coaxial negro. No se puede cortar o manipular.  
Black coaxial cable. Cannot be cut or handled.

Personalizable  
Customizable

Certificaciones  
Certifications

Recambios / Spare parts:

DRIP  
R2599438 Vidrio transparente / Transparent glass  
R2599439 Vidrio matizado / Frosted glass  
R2599481 Vidrio verde / Green glass  
R2599486 Vidrio azul / Blue glass  
R259124 Polycarbonato Opal/Opal Polycarbonate  
DROP  
R2590356 Vidrio transparente / Transparent glass  
R2590357 Vidrio matizado / Frosted glass  
R2590358 Vidrio verde / Green glass  
R2590359 Vidrio azul / Blue glass

## Descripción lámpara Drip / Lamps description Drip:

230V 50Hz IP-20 3 W LED / CRI: 90 / 2700°K  
345 lm fuente de luz / light source

Ref	Acabados / Finishing	Ean13	Euros
2590100738	Vidrio Transparente Transparent Glass	8436544897349	191,00
2590100739	Vidrio Matizado Frosted Glass	8436544897509	191,00
2590100781	Vidrio Verde Green Glass	8436544896922	191,00
2590100786	Vidrio Azul Blue Glass	8436544897936	191,00
25901007121	Polycarbonato Opal Opal Polycarbonate	8435493724836	154,00

## Descripción lámpara Drop / Lamps description Drop:

230V 50Hz IP-20 3 W LED / CRI: 90 / 2700°K  
345 lm fuente de luz / light source

Ref	Acabados / Finishing	Ean13	Euros
2590100756	Vidrio Transparente Transparent Glass	8436544895048	191,00
2590100757	Vidrio Matizado Frosted Glass	8436544896700	191,00
2590100758	Vidrio Verde Green Glass	8436544896717	191,00
2590100759	Vidrio Azul Blue Glass	8436544896724	191,00

## Familia / Family: Drip&Drop

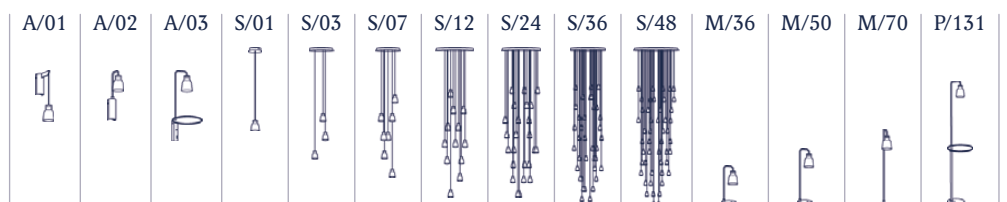

# Drip/Drop A/02

Diseño / Design:  
Christophe Mathieu / 2017

Tipología: Aplique  
Typology: Wall Lamp

Ambiente: Interior  
Environment: Indoor

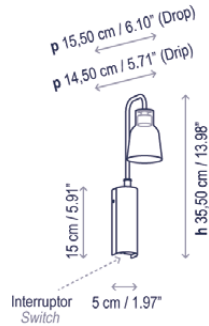

## Descripción técnica / Technical description:

(Drip) Peso Neto / Net Weight: 0,58 kg  
(Drop) Peso Neto / Net Weight: 0,60 kg

1 Caja/Box | 29 x 21 x 53 cm | 0,0323 m<sup>3</sup>  
(Drip) Peso bruto / Gross Weight: 1,26 kg  
(Drop) Peso bruto / Gross Weight: 1,28 kg

Materiales: Aluminio, Hierro,  
Vidrio borosilicado / Policarbonato  
Materials: Aluminum, Iron,  
Borosilicate glass / Polycarbonate

Acabado estructura color ébano negro  
Structure finish: ebony black

Con interruptor  
With switch

Caja soporte: 5 x 15 cm  
Surface back box: 1.97" x 5.91"

Personalizable  
Customizable

Certificaciones  
Certifications

## Recambios / Spare parts:

DRIP  
R2599438 Vidrio transparente / Transparent glass  
R2599439 Vidrio matizado / Frosted glass  
R2599481 Vidrio verde / Green glass  
R2599486 Vidrio azul / Blue glass  
R259124 Policarbonato Opal/Opal Polycarbonate  
DROP  
R2590356 Vidrio transparente / Transparent glass  
R2590357 Vidrio matizado / Frosted glass  
R2590358 Vidrio verde / Green glass  
R2590359 Vidrio azul / Blue glass

## Descripción lámpara Drip / Lamps description Drip:

230V 50Hz | IP-20 | 3 W LED / CRI: 90 / 2700°K  
345 lm fuente de luz / light source

Ref	Acabados / Finishing	Ean13	Euros
2590200738	Vidrio Transparente Transparent Glass	8436544897387	214,00
2590200739	Vidrio Matizado Frosted Glass	8436544897547	214,00
2590200781	Vidrio Verde Green Glass	8436544897585	214,00
2590200786	Vidrio Azul Blue Glass	8436544897974	214,00
25902007121	Policarbonato Opal Opal Polycarbonate	8435493724867	185,00

## Descripción lámpara Drop / Lamps description Drop:

230V 50Hz | IP-20 | 3 W LED / CRI: 90 / 2700°K  
345 lm fuente de luz / light source

Ref	Acabados / Finishing	Ean13	Euros
2590200756	Vidrio Transparente Transparent Glass	8436544895093	214,00
2590200757	Vidrio Matizado Frosted Glass	8436544896786	214,00
2590200758	Vidrio Verde Green Glass	8436544896793	214,00
2590200759	Vidrio Azul Blue Glass	8436544896809	214,00

## Familia / Family: Drip&Drop

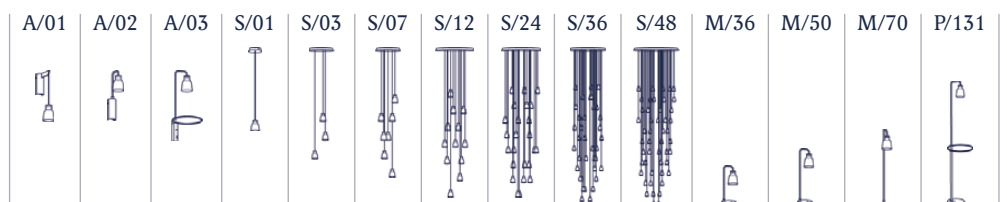

# Drip/Drop A/03

Diseño / Design:  
Christophe Mathieu / 2017

Tipología: Aplique  
Typology: Wall Lamp

Ambiente: Interior  
Environment: Indoor

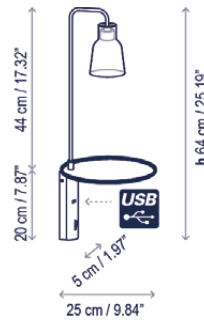

## Descripción técnica / Technical description:

(Drip) Peso Neto / Net Weight: 2,10 kg  
(Drop) Peso Neto / Net Weight: 2,13 kg

1 Caja/Box | 32 x 32 x 66 cm | 0,0676 m<sup>3</sup>  
(Drip) Peso bruto / Gross Weight: 3,33 kg  
(Drop) Peso bruto / Gross Weight: 3,35 kg

Materiales: Aluminio, Hierro,  
Vidrio borosilicato / Policarbonato  
Materials: Aluminum, Iron,  
Borosilicate glass / Polycarbonate

Acabado estructura color ébano negro  
Structure finish: ebony black

Tejido interior de la bandeja en color marrón  
topo. Capacidad de carga de la bandeja: 2kg.  
Con interruptor.  
The inside of the tray includes a taupe coated  
fabric. Weight capacity of the tray: 2kg.  
With switch.

Hilo incandescente tejido bandeja: 700°  
Tray fabric GWF1: 700°

Caja soporte: 5 x 25 cm  
Surface back box: 1.97" x 9.84"

USB: 5V 1A

Personalizable  
Customizable

Certificaciones  
Certifications

Recambios / Spare parts:

DRIP  
R2599438 Vidrio transparente / Transparent glass  
R2599439 Vidrio matizado / Frosted glass  
R2599481 Vidrio verde / Green glass  
R2599486 Vidrio azul / Blue glass  
R259124 Policarbonato Opal/Opal Polycarbonate  
DROP  
R2590356 Vidrio transparente / Transparent glass  
R2590357 Vidrio matizado / Frosted glass  
R2590358 Vidrio verde / Green glass  
R2590359 Vidrio azul / Blue glass

## Descripción lámpara Drip / Lamps description Drip:

230V 50Hz | IP-20 | 3 W LED / CRI: 90 / 2700°K  
345 lm fuente de luz / light source

Ref	Acabados / Finishing	Ean13	Euros
2590300738	Vidrio Transparente Transparent Glass	8436544897707	326,00
2590300739	Vidrio Matizado Frosted Glass	8436544897714	326,00
2590300781	Vidrio Verde Green Glass	8436544897844	326,00
2590300786	Vidrio Azul Blue Glass	8436544898001	326,00
25903007121	Policarbonato Opal Opal Polycarbonate	8435493724874	300,00

## Descripción lámpara Drop / Lamps description Drop:

230V 50Hz | IP-20 | 3 W LED / CRI: 90 / 2700°K  
345 lm fuente de luz / light source

Ref	Acabados / Finishing	Ean13	Euros
2590300756	Vidrio Transparente Transparent Glass	8436544895154	326,00
2590300757	Vidrio Matizado Frosted Glass	8436544896847	326,00
2590300758	Vidrio Verde Green Glass	8436544896908	326,00
2590300759	Vidrio Azul Blue Glass	8436544896960	326,00

## Familia / Family: Drip&Drop

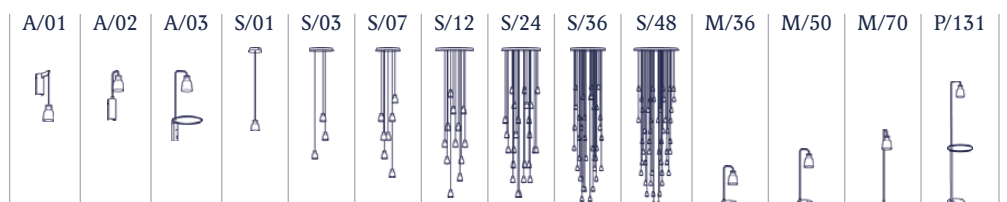



# Drip/Drop S/0 1L

Diseño / Design:  
Christophe Mathieu / 2017

Tipología: Suspensión  
Typology: Pendant Lamp

Ambiente: Interior  
Environment: Indoor



## Descripción técnica / Technical description:

(Drip) Peso Neto / Net Weight: 0,56 kg  
(Drop) Peso Neto / Net Weight: 0,57 kg

1 Caja/Box | 24 x 22 x 22 cm | 0,0116 m<sup>3</sup>  
(Drip) Peso bruto / Gross Weight: 1,02 kg  
(Drop) Peso bruto / Gross Weight: 1,04 kg

Materiales: Aluminio, Hierro,  
Vidrio borosilicato / Policarbonato  
Materials: Aluminum, Iron,  
Borosilicate glass / Polycarbonate

Acabado estructura color ébano negro  
Structure finish: ebony black

Cable coaxial negro, altura máxima 13 mts.  
No se pueden cortar o manipular. Existen  
13 largos de cable estándar para realizar  
diferentes composiciones. Consultar para  
medidas especiales.

Black coaxial cable, max. height 13 mts. Cannot  
be cut or handled. There are 13 standard cable  
lengths to make different compositions. Please  
consult for custom length options.

Personalizable  
Customizable

Certificaciones  
Certifications

Recambios / Spare parts:

R906019N Cable coaxial / Coaxial cable

DRIP

R2599438 Vidrio transparente / Transparent glass

R2599439 Vidrio matizado / Frosted glass

R2599481 Vidrio verde / Green glass

R2599486 Vidrio azul / Blue glass

R259124 Policarbonato Opal/Opal Polycarbonate

DROP

R2590356 Vidrio transparente / Transparent glass

R2590357 Vidrio matizado / Frosted glass

R2590358 Vidrio verde / Green glass

R2590359 Vidrio azul / Blue glass

## Descripción lámpara Drip / Lamps description Drip:

230V 50Hz | IP-20 | 3 W LED / CRI: 90 / 2700°K  
345 lm fuente de luz / light source

Ref	Acabados / Finishing	Ean13	Euros
2590120838	Vidrio Transparente Transparent Glass	8436544897356	185,00
2590120839	Vidrio Matizado Frosted Glass	8436544897516	185,00
2590120881	Vidrio Verde Green Glass	8436544897004	185,00
2590120886	Vidrio Azul Blue Glass	8436544897943	185,00
25901208121	Policarbonato Opal Opal Polycarbonate	8435493724911	146,00

## Descripción lámpara Drop / Lamps description Drop:

230V 50Hz | IP-20 | 3 W LED / CRI: 90 / 2700°K  
345 lm fuente de luz / light source

Ref	Acabados / Finishing	Ean13	Euros
2590120856	Vidrio Transparente Transparent Glass	8436544895260	185,00
2590120857	Vidrio Matizado Frosted Glass	8436544896663	185,00
2590120858	Vidrio Verde Green Glass	8436544896670	185,00
2590120859	Vidrio Azul Blue Glass	8436544896687	185,00

## Familia / Family: Drip&Drop

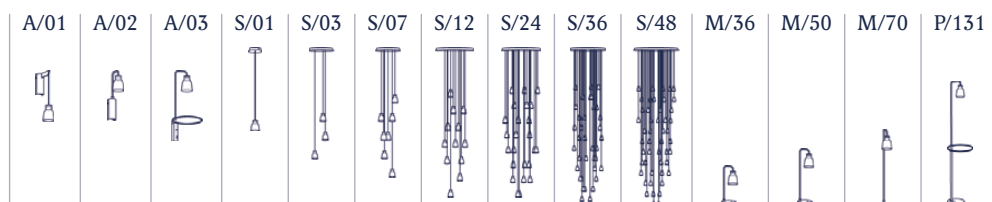

# Drip/Drop S/03L

Diseño / Design:  
Christophe Mathieu / 2017

Tipología: Suspensión  
Typology: Pendant Lamp

Ambiente: Interior  
Environment: Indoor

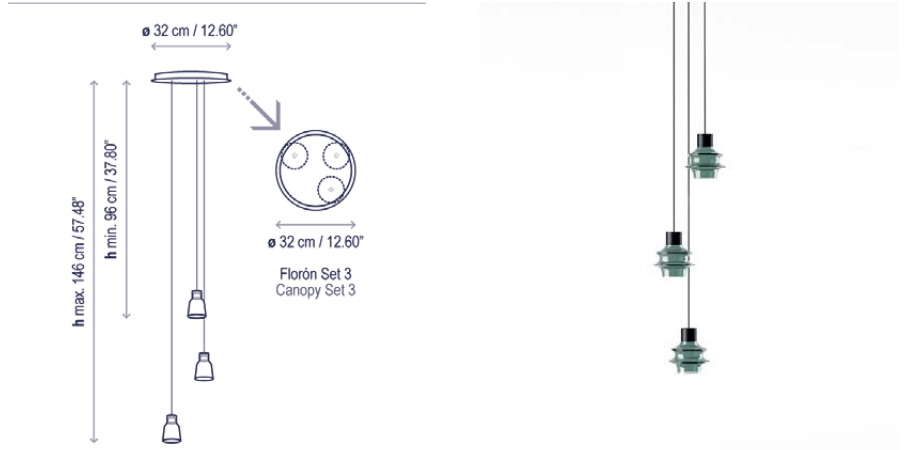

## Descripción técnica / Technical description:

(Drip) Peso Neto / Net Weight: 2,19 kg  
(Drop) Peso Neto / Net Weight: 2,25 kg

1 Caja/Box | 40 x 40 x 25 cm | 0,04 m<sup>3</sup>  
(Drip) Peso bruto / Gross Weight: 4,54 kg  
(Drop) Peso bruto / Gross Weight: 4,60 kg

Materiales: Aluminio, Hierro,  
Vidrio borosilicato / Policarbonato  
Materials: Aluminum, Iron,  
Borosilicate glass / Polycarbonate

Acabado estructura color ébano negro  
Structure finish: ebony black

Cable coaxial negro, altura máxima 13 mts.  
No se pueden cortar o manipular. Existen  
13 largos de cable estándar para realizar  
diferentes composiciones. Consultar para  
medidas especiales.

Black coaxial cable, max. height 13 mts. Cannot  
be cut or handled. There are 13 standard cable  
lengths to make different compositions. Please  
consult for custom length options.

Consulte la tabla de reguladores TRIAC  
recomendados en la página 212.  
Please check the list of recommended TRIAC  
dimmers at page 212.

Personalizable  
Customizable

Certificaciones  
Certifications

Recambios / Spare parts:

R906019N Cable coaxial / Coaxial cable

DRIP

R2599438 Vidrio transparente / Transparent glass

R2599439 Vidrio matizado / Frosted glass

R2599481 Vidrio verde / Green glass

R2599486 Vidrio azul / Blue glass

R259124 Policarbonato Opal/Opal Polycarbonate

DROP

R2590356 Vidrio transparente / Transparent glass

R2590357 Vidrio matizado / Frosted glass

R2590358 Vidrio verde / Green glass

R2590359 Vidrio azul / Blue glass

## Descripción lámpara Drip / Lamps description Drip:

230V  
50Hz IP-20 8,4 W LED / CRI: 90 / 2700°K  
1116 lm fuente de luz / light source

Ref	Acabados / Finishing	Ean13	Euros
2590321538	Regulable Triac - Vidrio Transparente Dimmable Triac - Transparent Glass	8436047305983	661,00
2590321539	Regulable Triac - Vidrio Matizado Dimmable Triac - Frosted Glass	8436047309844	661,00
2590321581	Regulable Triac - Vidrio Verde Dimmable Triac - Green Glass	8436544891026	661,00
2590321586	Regulable Triac - Vidrio Azul Dimmable Triac - Blue Glass	8436544893631	661,00
25903215121	Regulable Triac - Policarbonato Opal Dimmable Triac - Opal Polycarbonate	8435493724935	592,00

## Descripción lámpara Drop / Lamps description Drop:

230V  
50Hz IP-20 8,4 W LED / CRI: 90 / 2700°K  
1116 lm fuente de luz / light source

Ref	Acabados / Finishing	Ean13	Euros
2590321556	Regulable Triac - Vidrio Transparente Dimmable Triac - Transparent Glass	8436047309875	661,00
2590321557	Regulable Triac - Vidrio Matizado Dimmable Triac - Frosted Glass	8436535537629	661,00
2590321558	Regulable Triac - Vidrio Verde Dimmable Triac - Green Glass	8436535537643	661,00
2590321559	Regulable Triac - Vidrio Azul Dimmable Triac - Blue Glass	8436544893815	661,00

## Familia / Family: Drip&Drop

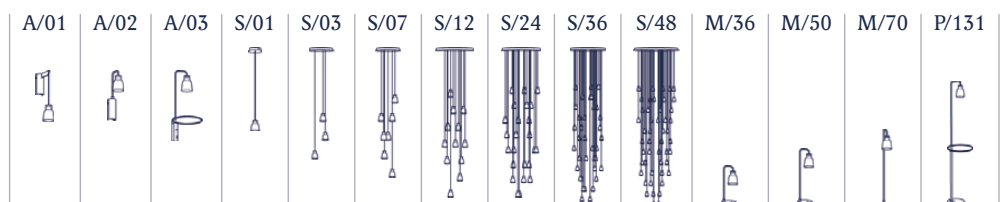



# Drip/Drop S/07L

Diseño / Design:  
Christophe Mathieu / 2017

Tipología: Suspensión  
Typology: Pendant Lamp

Ambiente: Interior  
Environment: Indoor

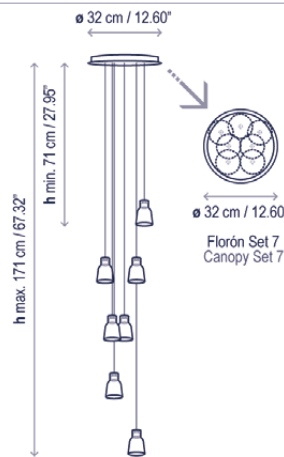

## Descripción técnica / Technical description:

(Drip) Peso Neto / Net Weight: 2,34 kg  
(Drop) Peso Neto / Net Weight: 2,48 kg

1 Caja/Box | 40 x 40 x 25 cm | 0,04 m<sup>3</sup>  
(Drip) Peso bruto / Gross Weight: 5,36 kg  
(Drop) Peso bruto / Gross Weight: 5,50 kg

Materiales: Aluminio, Hierro,  
Vidrio borosilicado / Policarbonato  
Materials: Aluminum, Iron,  
Borosilicate glass / Polycarbonate

Acabado estructura color ébano negro  
Structure finish: ebony black

Cable coaxial negro, altura máxima 13 mts.  
No se pueden cortar o manipular. Existen  
13 largos de cable estándar para realizar  
diferentes composiciones. Consultar para  
medidas especiales.

Black coaxial cable, max. height 13 mts. Cannot  
be cut or handled. There are 13 standard cable  
lengths to make different compositions. Please  
consult for custom length options.

Consulte la tabla de reguladores TRIAC  
recomendados en la página 212.  
Please check the list of recommended TRIAC  
dimmers at page 212.

Personalizable  
Customizable

Certificaciones  
Certifications

Recambios / Spare parts:

R906019N Cable coaxial / Coaxial cable

DRIP

R2599438 Vidrio transparente / Transparent glass

R2599439 Vidrio matizado / Frosted glass

R2599481 Vidrio verde / Green glass

R2599486 Vidrio azul / Blue glass

R259124 Policarbonato Opal/Opal Polycarbonate

DROP

R2590356 Vidrio transparente / Transparent glass

R2590357 Vidrio matizado / Frosted glass

R2590358 Vidrio verde / Green glass

R2590359 Vidrio azul / Blue glass

## Descripción lámpara Drip / Lamps description Drip:

230V  
50Hz | IP-20 | 19,6 W LED / CRI: 90 / 2700°K  
2604 lm fuente de luz / light source

Ref	Acabados / Finishing	Ean13	Euros
2590721538	Regulable Triac - Vidrio Transparente Dimmable Triac - Transparent Glass	8436544897455	1.262,00
2590721539	Regulable Triac - Vidrio Matizado Dimmable Triac - Frosted Glass	8436544897615	1.262,00
2590721581	Regulable Triac - Vidrio Verde Dimmable Triac - Green Glass	8436544897882	1.262,00
2590721586	Regulable Triac - Vidrio Azul Dimmable Triac - Blue Glass	8436544898032	1.262,00
25907215121	Regulable Triac - Policarbonato Opal Dimmable Triac - Opal Polycarbonate	8435493724973	1.014,00

## Descripción lámpara Drop / Lamps description Drop:

230V  
50Hz | IP-20 | 19,6 W LED / CRI: 90 / 2700°K  
2604 lm fuente de luz / light source

Ref	Acabados / Finishing	Ean13	Euros
2590721556	Regulable Triac - Vidrio Transparente Dimmable Triac - Transparent Glass	8436544897066	1.262,00
2590721557	Regulable Triac - Vidrio Matizado Dimmable Triac - Frosted Glass	8436544897080	1.262,00
2590721558	Regulable Triac - Vidrio Verde Dimmable Triac - Green Glass	8436544897134	1.262,00
2590721559	Regulable Triac - Vidrio Azul Dimmable Triac - Blue Glass	8436544897189	1.262,00

## Familia / Family: Drip&Drop

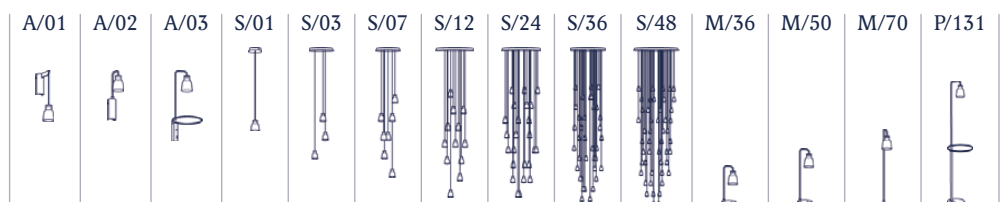

# Drip/Drop S/12L

Diseño / Design:  
Christophe Mathieu / 2017

Tipología: Suspensión  
Typology: Pendant Lamp

Ambiente: Interior  
Environment: Indoor

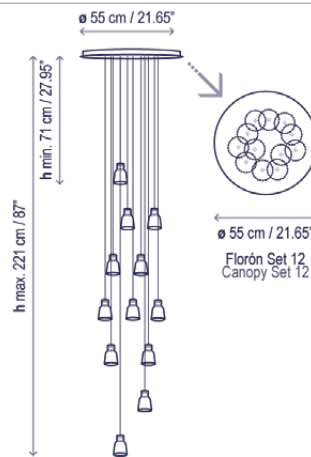

## Descripción técnica / Technical description:

(Drip) Peso Neto / Net Weight: 7,57 kg  
(Drop) Peso Neto / Net Weight: 8,05 kg

1 Caja/Box | 67 x 67 x 25 cm | 0,1122 m<sup>3</sup>  
(Drip) Peso bruto / Gross Weight: 12,84 kg  
(Drop) Peso bruto / Gross Weight: 13,32 kg

Materiales: Aluminio, Hierro,  
Vidrio borosilicado / Policarbonato  
Materials: Aluminum, Iron,  
Borosilicate glass / Polycarbonate

Acabado estructura color ébano negro  
Structure finish: ebony black

Cable coaxial negro, altura máxima 13 mts.  
No se pueden cortar o manipular. Existen  
13 largos de cable estándar para realizar  
diferentes composiciones. Consultar para  
medidas especiales.

Black coaxial cable, max. height 13 mts. Cannot  
be cut or handled. There are 13 standard cable  
lengths to make different compositions. Please  
consult for custom length options.

Consulte la tabla de reguladores TRIAC  
recomendados en la página 212.  
Please check the list of recommended TRIAC  
dimmers at page 212.

Personalizable  
Customizable

Certificaciones  
Certifications

Recambios / Spare parts:

R906019N Cable coaxial / Coaxial cable

DRIP

R2599438 Vidrio transparente / Transparent glass

R2599439 Vidrio matizado / Frosted glass

R2599481 Vidrio verde / Green glass

R2599486 Vidrio azul / Blue glass

R259124 Policarbonato Opal/Opal Polycarbonate

DROP

R2590356 Vidrio transparente / Transparent glass

R2590357 Vidrio matizado / Frosted glass

R2590358 Vidrio verde / Green glass

R2590359 Vidrio azul / Blue glass

## Descripción lámpara Drip / Lamps description Drip:

230V  
50HZ | IP-20 | 53,6 W LED / CRI: 90 / 2700°K  
4464 lm fuente de luz / light source

Ref	Acabados / Finishing	Ean13	Euros
2591221538	Regulable Triac - Vidrio Transparente Dimmable Triac - Transparent Glass	8436544897462	2.193,00
2591221539	Regulable Triac - Vidrio Matizado Dimmable Triac - Frosted Glass	8436544897622	2.193,00
2591221581	Regulable Triac - Vidrio Verde Dimmable Triac - Green Glass	8436544897899	2.193,00
2591221586	Regulable Triac - Vidrio Azul Dimmable Triac - Blue Glass	8436544898049	2.193,00
25912215121	Regulable Triac - Policarbonato Opal Dimmable Triac - Opal Polycarbonate	8435493724997	1.756,00

## Descripción lámpara Drop / Lamps description Drop:

230V  
50HZ | IP-20 | 53,6 W LED / CRI: 90 / 2700°K  
4464 lm fuente de luz / light source

Ref	Acabados / Finishing	Ean13	Euros
2591221556	Regulable Triac - Vidrio Transparente Dimmable Triac - Transparent Glass	8436544897073	2.193,00
2591221557	Regulable Triac - Vidrio Matizado Dimmable Triac - Frosted Glass	8436544897097	2.193,00
2591221558	Regulable Triac - Vidrio Verde Dimmable Triac - Green Glass	8436544897141	2.193,00
2591221559	Regulable Triac - Vidrio Azul Dimmable Triac - Blue Glass	8436544897196	2.193,00

## Familia / Family: Drip&Drop

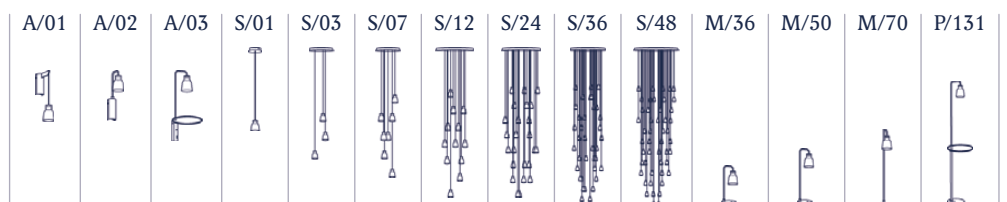

# Drip/Drop S/24L

Diseño / Design:  
Christophe Mathieu / 2017

Tipología: Suspensión  
Typology: Pendant Lamp

Ambiente: Interior  
Environment: Indoor

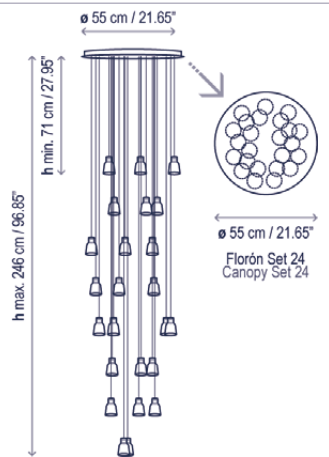

## Descripción técnica / Technical description:

(Drip) Peso Neto / Net Weight: 10,76 kg  
(Drop) Peso Neto / Net Weight: 11 kg

1 Caja/Box | 67 x 67 x 57 cm | 0,2559 m<sup>3</sup>  
(Drip) Peso bruto / Gross Weight: 14,96 kg  
(Drop) Peso bruto / Gross Weight: 15,2 kg

Materiales: Aluminio, Hierro,  
Vidrio borosilicado / Policarbonato  
Materials: Aluminum, Iron,  
Borosilicate glass / Polycarbonate

Acabado estructura color ébano negro  
Structure finish: ebony black

Cable coaxial negro, altura máxima 13 mts.  
No se pueden cortar o manipular. Existen  
13 largos de cable estándar para realizar  
diferentes composiciones. Consultar para  
medidas especiales.

Black coaxial cable, max. height 13 mts. Cannot  
be cut or handled. There are 13 standard cable  
lengths to make different compositions. Please  
consult for custom length options.

Consultar por versión sin pantallas de cristal  
Consult for version without glass shades

Personalizable  
Customizable

Certificaciones  
Certifications

Recambios / Spare parts:

R906019N Cable coaxial / Coaxial cable

DRIP  
R2599438 Vidrio transparente / Transparent glass  
R2599439 Vidrio matizado / Frosted glass  
R2599481 Vidrio verde / Green glass  
R2599486 Vidrio azul / Blue glass  
R259124 Policarbonato Opal/Opal Polycarbonate

DROP  
R2590356 Vidrio transparente / Transparent glass  
R2590357 Vidrio matizado / Frosted glass  
R2590358 Vidrio verde / Green glass  
R2590359 Vidrio azul / Blue glass

## Descripción lámpara Drip / Lamps description Drip:

230V 50Hz IP-20 1-10V 67,2 W LED / CRI: 90 / 2700°K  
8928 lm fuente de luz / light source

Ref	Acabados / Finishing	Ean13	Euros
2592421038	Regulable 1-10v - Vidrio Transparente Dimmable 1-10v - Transparent Glass	8436544897479	4.103,00
2592421039	Regulable 1-10v - Vidrio Matizado Dimmable 1-10v - Frosted Glass	8436544897639	4.103,00
2592421081	Regulable 1-10v - Vidrio Verde Dimmable 1-10v - Green Glass	8436544897905	4.103,00
2592421086	Regulable 1-10v - Vidrio Azul Dimmable 1-10v - Blue Glass	8436544898056	4.103,00
25924210121	Regulable Triac - Policarbonato Opal Dimmable Triac - Opal Polycarbonate	8435493725017	3.171,00

## Descripción lámpara Drop / Lamps description Drop:

230V 50Hz IP-20 1-10V 67,2 W LED / CRI: 90 / 2700°K  
8928 lm fuente de luz / light source

Ref	Acabados / Finishing	Ean13	Euros
2592421056	Regulable 1-10v - Vidrio Transparente Dimmable 1-10v - Transparent Glass	8436544896632	4.103,00
2592421057	Regulable 1-10v - Vidrio Matizado Dimmable 1-10v - Frosted Glass	8436544897103	4.103,00
2592421058	Regulable 1-10v - Vidrio Verde Dimmable 1-10v - Green Glass	8436544897158	4.103,00
2592421059	Regulable 1-10v - Vidrio Azul Dimmable 1-10v - Blue Glass	8436544897219	4.103,00

## Familia / Family: Drip&Drop

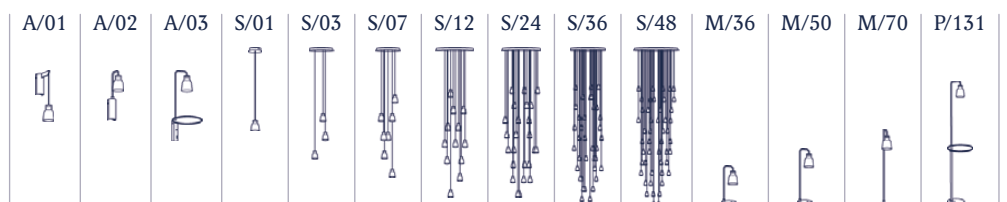

# Drip/Drop S/36L

Diseño / Design:  
Christophe Mathieu / 2017

Tipología: Suspensión  
Typology: Pendant Lamp

Ambiente: Interior  
Environment: Indoor

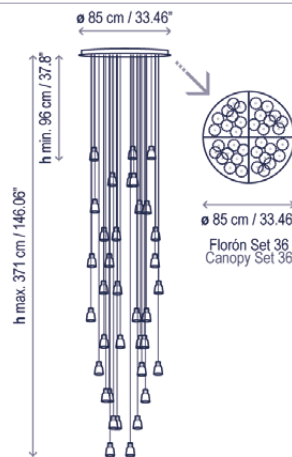

## Descripción técnica / Technical description:

(Drip) Peso Neto / Net Weight: 21,65 kg  
(Drop) Peso Neto / Net Weight: 22,37 kg

2 Cajas / 2 Boxes:

1 Caja/Box | 67 x 67 x 57 cm | 0,2559 m<sup>3</sup>  
(Drip) Peso bruto / Gross Weight: 28,67 kg  
(Drop) Peso bruto / Gross Weight: 29,39 kg

1 Caja/Box | 61 x 50 x 61 cm | 0,1861 m<sup>3</sup>  
(Drip) Peso bruto / Gross Weight: 9,52 kg  
(Drop) Peso bruto / Gross Weight: 9,52 kg

Materiales: Aluminio, Hierro, Vidrio/ Policarbonato  
Materials: Aluminum, Iron, Glass/ Polycarbonate

Acabado estructura color ébano negro  
Structure finish: ebony black

Cable coaxial negro, altura máxima 13 mts.  
No se pueden cortar o manipular. Existen 13 largos de cable estándar para realizar diferentes composiciones. Consultar para medidas especiales.

Black coaxial cable, max. height 13 mts. Cannot be cut or handled. There are 13 standard cable lengths to make different compositions. Please consult for custom length options.

Consultar por versión sin pantallas de cristal  
Consult for version without glass shades

Personalizable  
Customizable

Certificaciones  
Certifications

Recambios / Spare parts:

R906019N Cable coaxial / Coaxial cable

DRIP

R2599438 Vidrio transparente / Transparent glass

R2599439 Vidrio matizado / Frosted glass

R2599481 Vidrio verde / Green glass

R2599486 Vidrio azul / Blue glass

R259124 Policarbonato Opal/Opal Polycarbonate

DROP

R2590356 Vidrio transparente / Transparent glass

R2590357 Vidrio matizado / Frosted glass

R2590358 Vidrio verde / Green glass

R2590359 Vidrio azul / Blue glass

## Descripción lámpara Drip / Lamps description Drip:

Ref	Acabados / Finishing	Ean13	Euros
2593621038	Regulable 1-10v - Vidrio Transparente Dimmable 1-10v - Transparent Glass	8436544897486	6.425,00
2593621039	Regulable 1-10v - Vidrio Matizado Dimmable 1-10v - Frosted Glass	8436544897646	6.425,00
2593621081	Regulable 1-10v - Vidrio Verde Dimmable 1-10v - Green Glass	8436544897912	6.425,00
2593621086	Regulable 1-10v - Vidrio Azul Dimmable 1-10v - Blue Glass	8436544898063	6.425,00
25936210121	Regulable 1-10v - Policarbonato Opal Dimmable 1-10v - Opal Polycarbonate	8435493725031	5.132,00

## Descripción lámpara Drop / Lamps description Drop:

Ref	Acabados / Finishing	Ean13	Euros
2593621056	Regulable 1-10v - Vidrio Transparente Dimmable 1-10v - Transparent Glass	8436544896649	6.425,00
2593621057	Regulable 1-10v - Vidrio Matizado Dimmable 1-10v - Frosted Glass	8436544897110	6.425,00
2593621058	Regulable 1-10v - Vidrio Verde Dimmable 1-10v - Green Glass	8436544897165	6.425,00
2593621059	Regulable 1-10v - Vidrio Azul Dimmable 1-10v - Blue Glass	8436544897202	6.425,00

Familia / Family: Drip&Drop

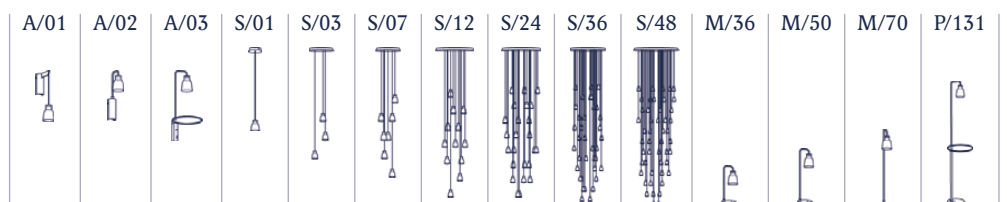



# Drip/Drop S/48L

Diseño / Design:  
Christophe Mathieu / 2017

Tipología: Suspensión  
Typology: Pendant Lamp

Ambiente: Interior  
Environment: Indoor

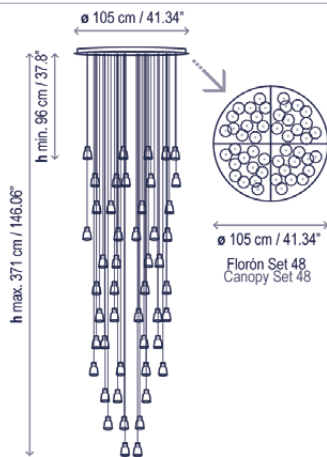

## Descripción técnica / Technical description:

(Drip) Peso Neto / Net Weight: 23,04 kg  
(Drop) Peso Neto / Net Weight: 24 kg

2 Cajas / 2 Boxes:

1 Caja/Box | 67 x 67 x 57 cm | 0,2559 m<sup>3</sup>  
(Drip) Peso bruto / Gross Weight: 37,04 kg  
(Drop) Peso bruto / Gross Weight: 38 kg

1 Caja/Box | 61 x 50 x 61 cm | 0,1861 m<sup>3</sup>  
(Drip) Peso bruto / Gross Weight: 12,32 kg  
(Drop) Peso bruto / Gross Weight: 12,32 kg

Materiales: Aluminio, Hierro, Vidrio/ Policarbonato  
Materials: Aluminum, Iron, Glass/ Polycarbonate

Acabado estructura color ébano negro  
Structure finish: ebony black

Cable coaxial negro, altura máxima 13 mts.  
No se pueden cortar o manipular. Existen 13 largos de cable estándar para realizar diferentes composiciones. Consultar para medidas especiales.

Black coaxial cable, max. height 13 mts. Cannot be cut or handled. There are 13 standard cable lengths to make different compositions. Please consult for custom length options.

Consultar por versión sin pantallas de cristal  
Consult for version without glass shades

Personalizable  
Customizable

Certificaciones  
Certifications

Recambios / Spare parts:

R906019N Cable coaxial / Coaxial cable

DRIP

R2599438 Vidrio transparente / Transparent glass

R2599439 Vidrio matizado / Frosted glass

R2599481 Vidrio verde / Green glass

R2599486 Vidrio azul / Blue glass

R259124 Policarbonato Opal/Opal Polycarbonate

DROP

R2590356 Vidrio transparente / Transparent glass

R2590357 Vidrio matizado / Frosted glass

R2590358 Vidrio verde / Green glass

R2590359 Vidrio azul / Blue glass

## Descripción lámpara Drip / Lamps description Drip:

230V 50Hz IP-20 1-10V 134,4 W LED / CRI: 90 / 2700°K 17856 lm fuente de luz / light source

Ref	Acabados / Finishing	Ean13	Euros
2594821038	Regulable 1-10v - Vidrio Transparente Dimmable 1-10v - Transparent Glass	8436544897493	8.228,00
2594821039	Regulable 1-10v - Vidrio Matizado Dimmable 1-10v - Frosted Glass	8436544897653	8.228,00
2594821081	Regulable 1-10v - Vidrio Verde Dimmable 1-10v - Green Glass	8436544897929	8.228,00
2594821086	Regulable 1-10v - Vidrio Azul Dimmable 1-10v - Blue Glass	8436544898070	8.228,00
25948210121	Regulable 1-10v - Policarbonato Opal Dimmable 1-10v - Opal Polycarbonate	8435493725055	6.926,00

## Descripción lámpara Drop / Lamps description Drop:

230V 50Hz IP-20 1-10V 134,4 W LED / CRI: 90 / 2700°K 17856 lm fuente de luz / light source

Ref	Acabados / Finishing	Ean13	Euros
2594821056	Regulable 1-10v - Vidrio Transparente Dimmable 1-10v - Transparent Glass	8436544896656	8.228,00
2594821057	Regulable 1-10v - Vidrio Matizado Dimmable 1-10v - Frosted Glass	8436544897127	8.228,00
2594821058	Regulable 1-10v - Vidrio Verde Dimmable 1-10v - Green Glass	8436544897172	8.228,00
2594821059	Regulable 1-10v - Vidrio Azul Dimmable 1-10v - Blue Glass	8436544897226	8.228,00

Familia / Family: Drip&Drop

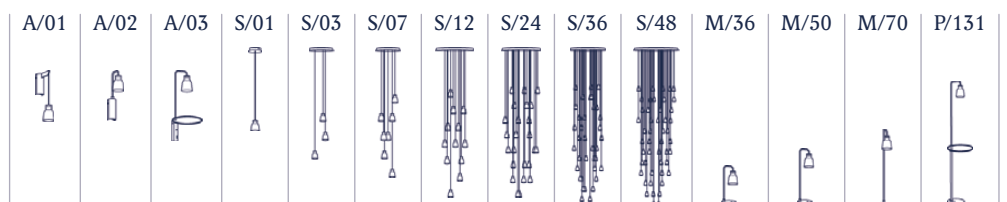

# Drip/Drop M/36

Diseño / Design:  
Christophe Mathieu / 2017

Tipología: Mesa  
Typology: Table Lamp

Ambiente: Interior  
Environment: Indoor

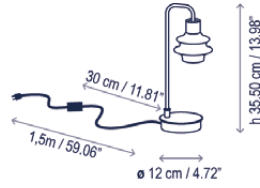

Interruptor en el cable / Through cord switch

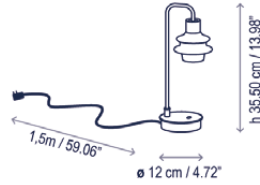

Interruptor Proxy Dimmer / Proxy Dimmer Switch



## Descripción técnica / Technical description:

(Drip) Peso Neto / Net Weight: 0,98 kg  
(Drop) Peso Neto / Net Weight: 1 kg

1 Caja/Box | 28 x 28 x 41 cm | 0,0321 m<sup>3</sup>  
(Drip) Peso bruto / Gross Weight: 1,75 kg  
(Drop) Peso bruto / Gross Weight: 1,78 kg

Materiales: Aluminio, Hierro,  
Vidrio borosilicato / Policarbonato  
Materials: Aluminum, Iron,  
Borosilicate glass / Polycarbonate

Acabado estructura color ébano negro  
Structure finish: ebony black

\*Nota: el sensor proxy conserva luz azul  
latente cuando la lámpara está apagada.  
\*Note: while in off position, the blue proxy  
sensor is illuminated.

Personalizable  
Customizable

Certificaciones  
Certifications

Recambios / Spare parts:

DRIP  
R2599438 Vidrio transparente / Transparent glass  
R2599439 Vidrio matizado / Frosted glass  
R2599481 Vidrio verde / Green glass  
R2599486 Vidrio azul / Blue glass  
R259124 Policarbonato Opal/Opal Polycarbonate

DROP  
R2590356 Vidrio transparente / Transparent glass  
R2590357 Vidrio matizado / Frosted glass  
R2590358 Vidrio verde / Green glass  
R2590359 Vidrio azul / Blue glass

## Descripción lámpara Drip / Lamps description Drip:

250V 50HZ IP-20 3 W LED / CRI: 90 / 2700°K  
345 lm fuente de luz / light source

Ref	Acabados / Finishing	Ean13	Euros
2590130338	Interruptor en el cable - Vidrio Transparente Through Cord Switch - Transparent Glass	8436544897363	262,00
2590130339	Interruptor en el cable - Vidrio Matizado Through Cord Switch - Frosted Glass	8436544897523	262,00
2590130381	Interruptor en el cable - Vidrio Verde Through Cord Switch - Green Glass	8436544897042	262,00
2590130386	Interruptor en el cable - Vidrio Azul Through Cord Switch - Blue Glass	8436544897950	262,00
25901303121	Interruptor en el cable - Policarbonato Opal Through Cord Switch - Opal Polycarbonate	8435493725079	223,00
*2590131238	Interruptor Proxy Dimmer - Vidrio Transparente Proxy Dimmer Switch - Transparent Glass	8436544897370	305,00
*2590131239	Interruptor Proxy Dimmer - Vidrio Matizado Proxy Dimmer Switch - Frosted Glass	8436544897530	305,00
*2590131281	Interruptor Proxy Dimmer - Vidrio Verde Proxy Dimmer Switch - Green Glass	8436544897424	305,00
*2590131286	Interruptor Proxy Dimmer - Vidrio Azul Proxy Dimmer Switch - Blue Glass	8436544897967	305,00
*25901312121	Interruptor Proxy Dimmer - Policarbonato Opal Proxy Dimmer Switch - Opal Polycarbonate	8435493725093	263,00

## Descripción lámpara Drop / Lamps description Drop:

Ref	Acabados / Finishing	Ean13	Euros
2590130356	Interruptor en el cable - Vidrio Transparente Through Cord Switch - Transparent Glass	8436544896281	262,00
2590130357	Interruptor en el cable - Vidrio Matizado Through Cord Switch - Frosted Glass	8436544896748	262,00
2590130358	Interruptor en el cable - Vidrio Verde Through Cord Switch - Green Glass	8436544896755	262,00
2590130359	Interruptor en el cable - Vidrio Azul Through Cord Switch - Blue Glass	8436544896762	262,00
*2590131256	Interruptor Proxy Dimmer - Vidrio Transparente Proxy Dimmer Switch - Transparent Glass	8436544896274	305,00
*2590131257	Interruptor Proxy Dimmer - Vidrio Matizado Proxy Dimmer Switch - Frosted Glass	8436544896823	305,00
*2590131258	Interruptor Proxy Dimmer - Vidrio Verde Proxy Dimmer Switch - Green Glass	8436544896892	305,00
*2590131259	Interruptor Proxy Dimmer - Vidrio Azul Proxy Dimmer Switch - Blue Glass	8436544896946	305,00

Familia / Family: Drip&Drop

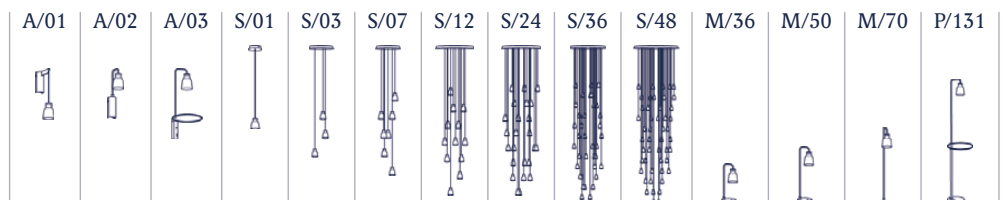

# Drip/Drop M/50

Diseño / Design:  
Christophe Mathieu / 2017

Tipología: Mesa  
Typology: Table Lamp

Ambiente: Interior  
Environment: Indoor

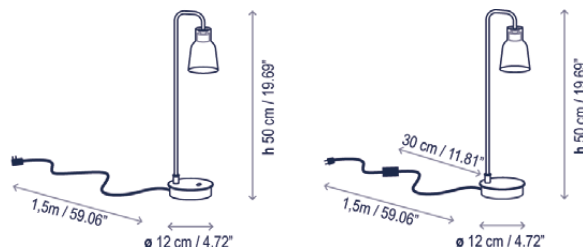

Interruptor Proxy Dimmer / Proxy Dimmer Switch

Interruptor en el cable / Through cord switch



## Descripción técnica / Technical description:

(Drip) Peso Neto / Net Weight: 1,02 kg  
(Drop) Peso Neto / Net Weight: 1,04 kg

1 Caja/Box | 29 x 21 x 53 cm | 0,0323 m<sup>3</sup>  
(Drip) Peso bruto / Gross Weight: 1,75 kg  
(Drop) Peso bruto / Gross Weight: 1,78 kg

Materiales: Aluminio, Hierro,  
Vidrio borosilicato / Policarbonato  
Materials: Aluminum, Iron,  
Borosilicate glass / Polycarbonate

Acabado estructura color ébano negro  
Structure finish: ebony black

\*Nota: el sensor proxy conserva luz azul  
latente cuando la lámpara está apagada.  
\*Note: while in off position, the blue proxy  
sensor is illuminated.

Personalizable  
Customizable

Certificaciones  
Certifications

Recambios / Spare parts:

DRIP  
R2599438 Vidrio transparente / Transparent glass  
R2599439 Vidrio matizado / Frosted glass  
R2599481 Vidrio verde / Green glass  
R2599486 Vidrio azul / Blue glass  
R259124 Policarbonato Opal/Opal Polycarbonate

DROP  
R2590356 Vidrio transparente / Transparent glass  
R2590357 Vidrio matizado / Frosted glass  
R2590358 Vidrio verde / Green glass  
R2590359 Vidrio azul / Blue glass

## Descripción lámpara Drip / Lamps description Drip:

230V 50Hz IP-20 3 W LED / CRI: 90 / 2700°K  
345 lm fuente de luz / light source

Ref	Acabados / Finishing	Ean13	Euros
2590230338	Interruptor en el cable - Vidrio Transparente Through Cord Switch - Transparent Glass	8436544897394	266,00
2590230339	Interruptor en el cable - Vidrio Matizado Through Cord Switch - Frosted Glass	8436544897554	266,00
2590230381	Interruptor en el cable - Vidrio Verde Through Cord Switch - Green Glass	8436544897820	266,00
2590230386	Interruptor en el cable - Vidrio Azul Through Cord Switch - Blue Glass	8436544897981	266,00
25902303121	Interruptor en el cable - Policarbonato Opal Through Cord Switch - Opal Polycarbonate	8435493725116	240,00
*2590231238	Interruptor Proxy Dimmer - Vidrio Transparente Proxy Dimmer Switch - Transparent Glass	8436544897400	309,00
*2590231239	Interruptor Proxy Dimmer - Vidrio Matizado Proxy Dimmer Switch - Frosted Glass	8436544897561	309,00
*2590231281	Interruptor Proxy Dimmer - Vidrio Verde Proxy Dimmer Switch - Green Glass	8436544897837	309,00
*2590231286	Interruptor Proxy Dimmer - Vidrio Azul Proxy Dimmer Switch - Blue Glass	8436544897998	309,00
*25902312121	Interruptor Proxy Dimmer - Policarbonato Opal Proxy Dimmer Switch - Opal Polycarbonate	8435493725130	283,00

## Descripción lámpara Drop / Lamps description Drop:

Ref	Acabados / Finishing	Ean13	Euros
2590230356	Interruptor en el cable - Vidrio Transparente Through Cord Switch - Transparent Glass	8436544897769	266,00
2590230357	Interruptor en el cable - Vidrio Matizado Through Cord Switch - Frosted Glass	8436544896830	266,00
2590230358	Interruptor en el cable - Vidrio Verde Through Cord Switch - Green Glass	8436544896885	266,00
2590230359	Interruptor en el cable - Vidrio Azul Through Cord Switch - Blue Glass	8436544896953	266,00
*2590231256	Interruptor Proxy Dimmer - Vidrio Transparente Proxy Dimmer Switch - Transparent Glass	8436544895086	309,00
*2590231257	Interruptor Proxy Dimmer - Vidrio Matizado Proxy Dimmer Switch - Frosted Glass	8436544897721	309,00
*2590231258	Interruptor Proxy Dimmer - Vidrio Verde Proxy Dimmer Switch - Green Glass	8436544897738	309,00
*2590231259	Interruptor Proxy Dimmer - Vidrio Azul Proxy Dimmer Switch - Blue Glass	8436544897745	309,00

Familia / Family: Drip&Drop

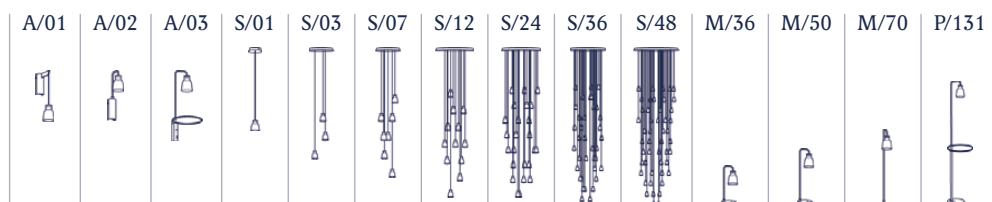

# Drip/Drop M/70

Diseño / Design:  
Christophe Mathieu / 2017

Tipología: Mesa  
Typology: Table Lamp

Ambiente: Interior  
Environment: Indoor

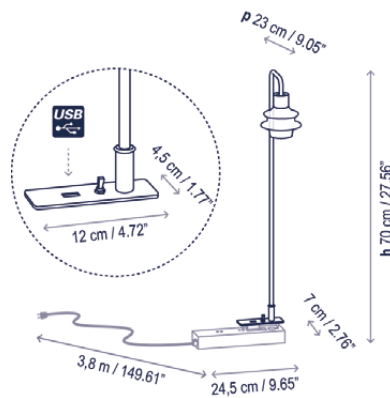

## Descripción técnica / Technical description:

(Drip) Peso Neto / Net Weight: 1,73 kg  
(Drop) Peso Neto / Net Weight: 1,62 kg

1 Caja/Box | 31 x 108 x 31 cm | 0,1038 m<sup>3</sup>  
(Drip) Peso bruto / Gross Weight: 3,50 kg  
(Drop) Peso bruto / Gross Weight: 3,52 kg

Materiales: Aluminio, Hierro,  
Vidrio borosilicato / Polycarbonato  
Materials: Aluminum, Iron,  
Borosilicate glass / Polycarbonate

Acabado estructura color ébano negro  
Structure finish: ebony black

Brazo fijo. Interruptor y entrada conector  
USB en la base.  
Fixed arm. Switch and USB port located on the  
base.

Con interruptor  
With switch

USB: 5V 1A

Personalizable  
Customizable

Certificaciones  
Certifications

Recambios / Spare parts:

DRIP  
R2599438 Vidrio transparente / Transparent glass  
R2599439 Vidrio matizado / Frosted glass  
R2599481 Vidrio verde / Green glass  
R2599486 Vidrio azul / Blue glass  
R259124 Polycarbonato Opal/Opal Polycarbonate  
DROP  
R2590356 Vidrio transparente / Transparent glass  
R2590357 Vidrio matizado / Frosted glass  
R2590358 Vidrio verde / Green glass  
R2590359 Vidrio azul / Blue glass

## Descripción lámpara Drip / Lamps description Drip:

230V 50Hz IP-20 3 W LED / CRI: 90 / 2700°K 345 lm fuente de luz / light source

Ref	Acabados / Finishing	Ean13	Euros
2590331338	Vidrio Transparente Transparent Glass	8436544897417	395,00
2590331339	Vidrio Matizado Frosted Glass	8436544897578	395,00
2590331381	Vidrio Verde Green Glass	8436544897851	395,00
2590331386	Vidrio Azul Blue Glass	8436544899947	395,00
25903313121	Polycarbonato Opal Opal Polycarbonate	8435493725154	318,00

## Descripción lámpara Drop / Lamps description Drop:

230V 50Hz IP-20 3 W LED / CRI: 90 / 2700°K 345 lm fuente de luz / light source

Ref	Acabados / Finishing	Ean13	Euros
2590331356	Vidrio Transparente Transparent Glass	8436544896298	395,00
2590331357	Vidrio Matizado Frosted Glass	8436544896854	395,00
2590331358	Vidrio Verde Green Glass	8436544896915	395,00
2590331359	Vidrio Azul Blue Glass	8436544896977	395,00

## Familia / Family: Drip&Drop

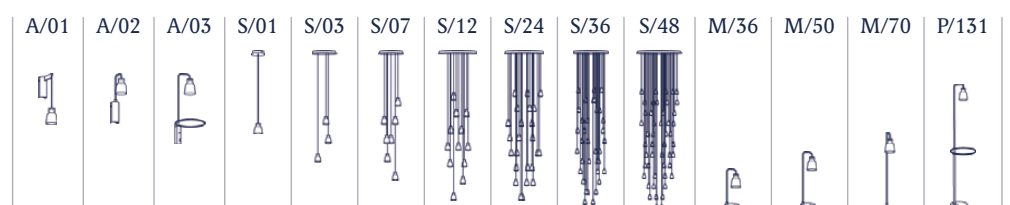



# Drip/Drop P/131

Diseño / Design:  
Christophe Mathieu / 2017

Tipología: Pie  
Typology: Floor Lamp

Ambiente: Interior  
Environment: Indoor

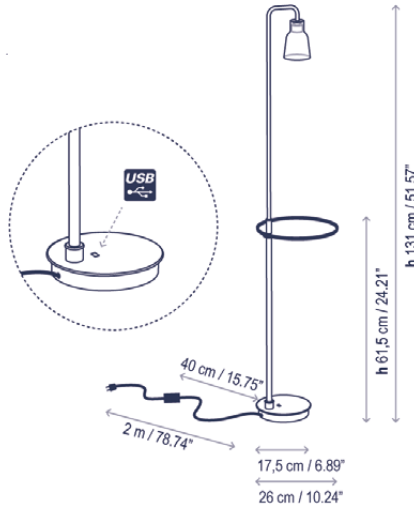

## Descripción técnica / Technical description:

(Drip) Peso Neto / Net Weight: 5,61 kg  
(Drop) Peso Neto / Net Weight: 5,63 kg

1 Caja/Box | 35 x 34 x 148 cm | 0,1761 m<sup>3</sup>  
(Drip) Peso bruto / Gross Weight: 8,79 kg  
(Drop) Peso bruto / Gross Weight: 8,82 kg

Materiales: Aluminio, Hierro,  
Vidrio borosilicado / Policarbonato  
Materials: Aluminum, Iron,  
Borosilicate glass / Polycarbonate

Acabado estructura color ébano negro  
Structure finish: ebony black

Interruptor en el cable. Entrada conector USB en la base. Tejido interior de la bandeja en color marrón topo. Capacidad de carga de la bandeja: 2kg.  
Switch through cord. USB port located on the base. The inside of the tray includes a taupe coated fabric. Weight capacity of the tray: 2kg.

Hilo incandescente tejido bandeja: 700°  
Tray fabric GWF: 700°

USB: 5V 1A

Personalizable  
Customizable

Certificaciones  
Certifications

Recambios / Spare parts:

DRIP  
R2599438 Vidrio transparente / Transparent glass  
R2599439 Vidrio matizado / Frosted glass  
R2599481 Vidrio verde / Green glass  
R2599486 Vidrio azul / Blue glass  
R259124 Policarbonato Opal/Opal Polycarbonate

DROP  
R2590356 Vidrio transparente / Transparent glass  
R2590357 Vidrio matizado / Frosted glass  
R2590358 Vidrio verde / Green glass  
R2590359 Vidrio azul / Blue glass

## Descripción lámpara Drip / Lamps description Drip:

230V 50Hz IP-20 3 W LED / CRI: 90 / 2700°K 345 lm fuente de luz / light source

Ref	Acabados / Finishing	Ean13	Euros
2590530338	Vidrio Transparente Transparent Glass	8436544897431	534,00
2590530339	Vidrio Matizado Frosted Glass	8436544897592	534,00
2590530381	Vidrio Verde Green Glass	8436544897868	534,00
2590530386	Vidrio Azul Blue Glass	8436544898018	534,00
25905303121	Policarbonato Opal Opal Polycarbonate	8435493725178	412,00

## Descripción lámpara Drop / Lamps description Drop:

230V 50Hz IP-20 3 W LED / CRI: 90 / 2700°K 345 lm fuente de luz / light source

Ref	Acabados / Finishing	Ean13	Euros
2590530356	Vidrio Transparente Transparent Glass	8436544895185	534,00
2590530357	Vidrio Matizado Frosted Glass	8436544897271	534,00
2590530358	Vidrio Verde Green Glass	8436544897301	534,00
2590530359	Vidrio Azul Blue Glass	8436544897288	534,00

## Familia / Family: Drip&Drop

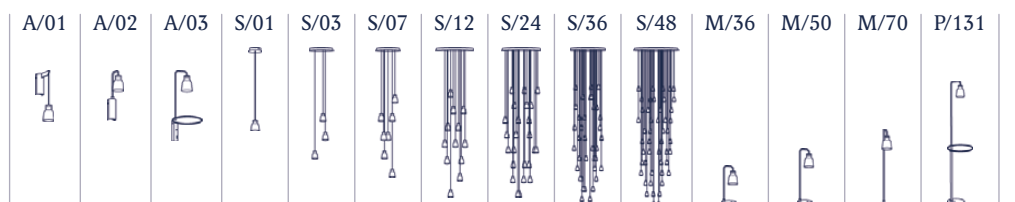

# Drip/Drop Linear PF/05L

Diseño / Design:  
Christophe Mathieu / 2017

Tipología: Plafón  
Typology: Ceiling lamp

Ambiente: Interior  
Environment: Indoor

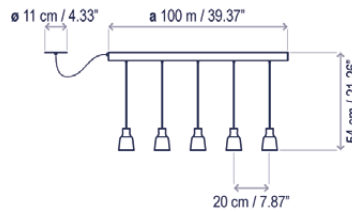

## Descripción técnica / Technical description:

Peso Neto: 1,42 kg  
Net Weight: 1,42 kg

1 Caja/Box | 33 x 24 x 19 cm | 0,015 m<sup>3</sup>  
Peso bruto / Gross Weight: 1,5 kg

1 Tubo/Tube | 147 x Ø9 cm | 0,0094 m<sup>3</sup>  
Peso bruto / Gross Weight: 1,65 kg

Materiales: Aluminio, Hierro, Policarbonato  
Materials: Aluminum, Iron, Polycarbonate

Acabado estructura color ébano negro  
Structure finish: ebony black

Driver remoto en falso techo  
False ceiling remote driver

Personalizable  
Customizable

Certificaciones  
Certifications

Recambios / Spare parts:

DRIP  
R2599438 Vidrio transparente / Transparent glass  
R2599439 Vidrio matizado / Frosted glass  
R2599481 Vidrio verde / Green glass  
R2599486 Vidrio azul / Blue glass  
R259124 Policarbonato Opal/Opal Polycarbonate

DROP  
R2590356 Vidrio transparente / Transparent glass  
R2590357 Vidrio matizado / Frosted glass  
R2590358 Vidrio verde / Green glass  
R2590359 Vidrio azul / Blue glass

## Descripción lámpara Drip / Lamps description Drip:

230V 50Hz IP-20 0/1-10V / DALI / PUSH 14 W LED / CRI: 90 / 2700°K 1860 lm fuente de luz / light source

Ref	Acabados / Finishing	Ean13	Euros
25955108038	Regulable 0/1-10v/Dali/Push - Vidrio Transparente Dimmable 0/1-10v/Dali/Push - Transparent Glass	8435493728001	888,00
25955108039	Regulable 0/1-10v/Dali/Push - Vidrio Matizado Dimmable 0/1-10v/Dali/Push - Frosted Glass	8435493728018	888,00
25955108081	Regulable 0/1-10v/Dali/Push - Vidrio Verde Dimmable 0/1-10v/Dali/Push - Green Glass	8435493728124	888,00
25955108086	Regulable 0/1-10v/Dali/Push - Vidrio Azul Dimmable 0/1-10v/Dali/Push - Blue Glass	8435493728148	888,00
25955108121	Regulable 0/1-10v/Dali/Push - Policarbonato Opal Dimmable 0/1-10v/Dali/Push - Opal Polycarbonate	8435493726380	837,00

## Descripción lámpara Drop / Lamps description Drop:

25955108056	Regulable 0/1-10v/Dali/Push - Vidrio Transparente Dimmable 0/1-10v/Dali/Push - Transparent Glass	8435493728025	888,00
25955108057	Regulable 0/1-10v/Dali/Push - Vidrio Matizado Dimmable 0/1-10v/Dali/Push - Frosted Glass	8435493728063	888,00
25955108058	Regulable 0/1-10v/Dali/Push - Vidrio Verde Dimmable 0/1-10v/Dali/Push - Green Glass	8435493728087	888,00
25955108059	Regulable 0/1-10v/Dali/Push - Vidrio Azul Dimmable 0/1-10v/Dali/Push - Blue Glass	8435493728100	888,00

Familia / Family: Drip/Drop Linear

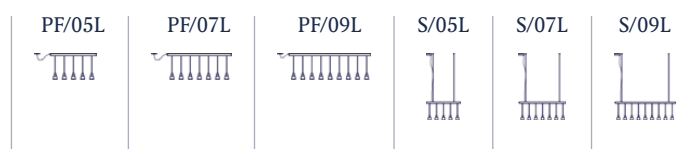

# Drip/Drop Linear PF/07L

Diseño / Design:  
Christophe Mathieu / 2017

Tipología: Plafón  
Typology: Ceiling lamp

Ambiente: Interior  
Environment: Indoor

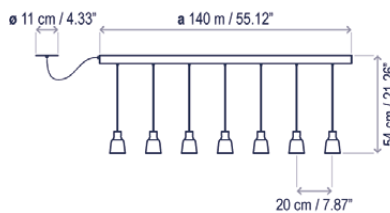

## Descripción técnica / Technical description:

Peso Neto: 1,99 kg  
Net Weight: 1,99 kg

1 Caja/Box | 40 x 40 x 25 cm | 0,04 m<sup>3</sup>  
Peso bruto / Gross Weight: 1,75 kg

1 Tubo/Tube | 187 x Ø9 cm | 0,0119 m<sup>3</sup>  
Peso bruto / Gross Weight: 2,22 kg

Materiales: Aluminio, Hierro, Policarbonato  
Materials: Aluminum, Iron, Polycarbonate

Acabado estructura color ébano negro  
Structure finish: ebony black

Driver remoto en falso techo  
False ceiling remote driver

Personalizable  
Customizable

Certificaciones  
Certifications

Recambios / Spare parts:

DRIP  
R2599438 Vidrio transparente / Transparent glass  
R2599439 Vidrio matizado / Frosted glass  
R2599481 Vidrio verde / Green glass  
R2599486 Vidrio azul / Blue glass  
R259124 Policarbonato Opal/Opal Polycarbonate

DROP  
R2590356 Vidrio transparente / Transparent glass  
R2590357 Vidrio matizado / Frosted glass  
R2590358 Vidrio verde / Green glass  
R2590359 Vidrio azul / Blue glass

## Descripción lámpara Drip / Lamps description Drip:

230V 50Hz IP-20 0/1-10V / DALI / PUSH 19,6 W LED / CRI: 90 / 2700°K  
2604 lm fuente de luz / light source

Ref	Acabados / Finishing	Ean13	Euros
25957108038	Regulable 0/1-10v/Dali/Push - Vidrio Transparente Dimmable 0/1-10v/Dali/Push - Transparent Glass	8435493728162	1.064,00
25957108039	Regulable 0/1-10v/Dali/Push - Vidrio Matizado Dimmable 0/1-10v/Dali/Push - Frosted Glass	8435493728360	1.064,00
25957108081	Regulable 0/1-10v/Dali/Push - Vidrio Verde Dimmable 0/1-10v/Dali/Push - Green Glass	8435493728209	1.064,00
25957108086	Regulable 0/1-10v/Dali/Push - Vidrio Azul Dimmable 0/1-10v/Dali/Push - Blue Glass	8435493728216	1.064,00
25957108121	Regulable 0/1-10v/Dali/Push - Policarbonato Opal Dimmable 0/1-10v/Dali/Push - Opal Polycarbonate	8435493726618	991,00

## Descripción lámpara Drop / Lamps description Drop:

25957108056	Regulable 0/1-10v/Dali/Push - Vidrio Transparente Dimmable 0/1-10v/Dali/Push - Transparent Glass	8435493728377	1.064,00
25957108057	Regulable 0/1-10v/Dali/Push - Vidrio Matizado Dimmable 0/1-10v/Dali/Push - Frosted Glass	8435493728179	1.064,00
25957108058	Regulable 0/1-10v/Dali/Push - Vidrio Verde Dimmable 0/1-10v/Dali/Push - Green Glass	8435493728186	1.064,00
25957108059	Regulable 0/1-10v/Dali/Push - Vidrio Azul Dimmable 0/1-10v/Dali/Push - Blue Glass	8435493728193	1.064,00

Familia / Family: Drip/Drop Linear

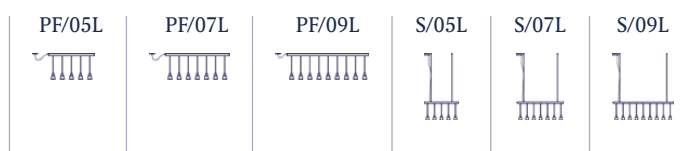

# Drip/Drop Linear PF/09L

Diseño / Design:  
Christophe Mathieu / 2017

Tipología: Plafón  
Typology: Ceiling lamp

Ambiente: Interior  
Environment: Indoor

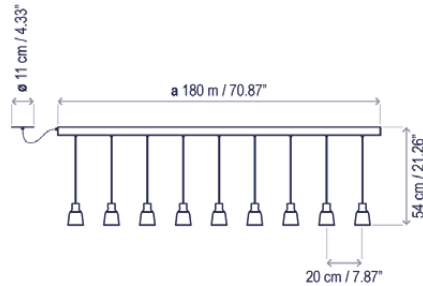

## Descripción técnica / Technical description:

Peso Neto: 2,55 kg  
Net Weight: 2,55 kg

1 Caja/Box | 47 x 47 x 37 cm | 0,0817 m<sup>3</sup>  
Peso bruto / Gross Weight: 1,93 kg

1 Tubo/Tube | 227 x Ø9 cm | 0,0144 m<sup>3</sup>  
Peso bruto / Gross Weight: 2,77 kg

Materiales: Aluminio, Hierro, Policarbonato  
Materials: Aluminum, Iron, Polycarbonate

Acabado estructura color ébano negro  
Structure finish: ebony black

Driver remoto en falso techo  
False ceiling remote driver

Personalizable  
Customizable

Certificaciones  
Certifications

Recambios / Spare parts:

DRIP  
R2599438 Vidrio transparente / Transparent glass  
R2599439 Vidrio matizado / Frosted glass  
R2599481 Vidrio verde / Green glass  
R2599486 Vidrio azul / Blue glass  
R259124 Policarbonato Opal/Opal Polycarbonate

DROP  
R2590356 Vidrio transparente / Transparent glass  
R2590357 Vidrio matizado / Frosted glass  
R2590358 Vidrio verde / Green glass  
R2590359 Vidrio azul / Blue glass

## Descripción lámpara Drip / Lamps description Drip:

230V 50Hz IP-20 0/1-10V / DALI / PUSH 25,2 W LED / CRI: 90 / 2700°K 3348 lm fuente de luz / light source

Ref	Acabados / Finishing	Ean13	Euros
25959108038	Regulable 0/1-10v/Dali/Push - Vidrio Transparente Dimmable 0/1-10v/Dali/Push - Transparent Glass	8435493728292	1.167,00
25959108039	Regulable 0/1-10v/Dali/Push - Vidrio Matizado Dimmable 0/1-10v/Dali/Push - Frosted Glass	8435493728308	1.167,00
25959108081	Regulable 0/1-10v/Dali/Push - Vidrio Verde Dimmable 0/1-10v/Dali/Push - Green Glass	8435493728339	1.167,00
25959108086	Regulable 0/1-10v/Dali/Push - Vidrio Azul Dimmable 0/1-10v/Dali/Push - Blue Glass	8435493728353	1.167,00
25959108121	Regulable 0/1-10v/Dali/Push - Policarbonato Opal Dimmable 0/1-10v/Dali/Push - Opal Polycarbonate	8435493726632	1.069,00

## Descripción lámpara Drop / Lamps description Drop:

25959108056	Regulable 0/1-10v/Dali/Push - Vidrio Transparente Dimmable 0/1-10v/Dali/Push - Transparent Glass	8435493728315	1.167,00
25959108057	Regulable 0/1-10v/Dali/Push - Vidrio Matizado Dimmable 0/1-10v/Dali/Push - Frosted Glass	8435493728421	1.167,00
25959108058	Regulable 0/1-10v/Dali/Push - Vidrio Verde Dimmable 0/1-10v/Dali/Push - Green Glass	8435493728322	1.167,00
25959108059	Regulable 0/1-10v/Dali/Push - Vidrio Azul Dimmable 0/1-10v/Dali/Push - Blue Glass	8435493728728	1.167,00

Familia / Family: Drip/Drop Linear

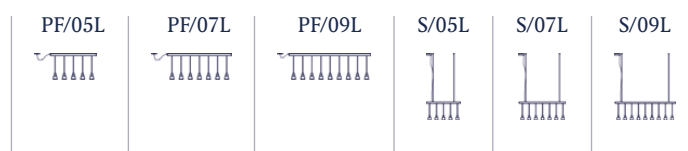

# Drip/Drop Linear S/05L

Diseño / Design:  
Christophe Mathieu / 2017

Tipología: Suspensión  
Typology: Pendant Lamp

Ambiente: Interior  
Environment: Indoor

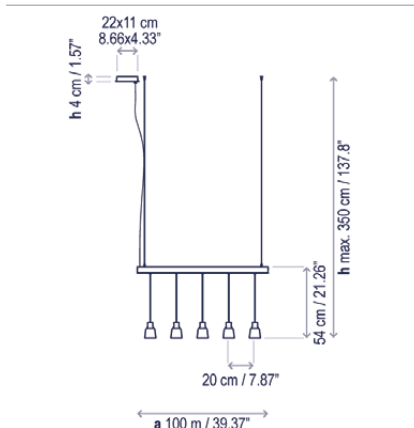

## Descripción técnica / Technical description:

Peso Neto: 1,42 kg  
Net Weight: 1,42 kg

1 Caja/Box | 33 x 24 x 19 cm | 0,015 m<sup>3</sup>  
Peso bruto / Gross Weight: 1,5 kg

1 Tubo/Tube | 147 x Ø9 cm | 0,0094 m<sup>3</sup>  
Peso bruto / Gross Weight: 1,65 kg

Materiales: Aluminio, Hierro, Policarbonato  
Materials: Aluminum, Iron, Polycarbonate

Acabado estructura color ébano negro  
Structure finish: ebony black

Personalizable  
Customizable

Certificaciones  
Certifications

Recambios / Spare parts:

DRIP

R2599438 Vidrio transparente / Transparent glass

R2599439 Vidrio matizado / Frosted glass

R2599481 Vidrio verde / Green glass

R2599486 Vidrio azul / Blue glass

R259124 Policarbonato Opal/Opal Polycarbonate

DROP

R2590356 Vidrio transparente / Transparent glass

R2590357 Vidrio matizado / Frosted glass

R2590358 Vidrio verde / Green glass

R2590359 Vidrio azul / Blue glass

## Descripción lámpara Drip / Lamps description Drip:

230V 50Hz IP-20 14 W LED / CRI: 90 / 2700°K 1860 lm fuente de luz / light source

Ref	Acabados / Finishing	Ean13	Euros
25955219038	Regulable 0/1-10v/Dali/Push - Vidrio Transparente Dimmable 0/1-10v/Dali/Push - Transparent Glass	8435493729145	888,00
25955219039	Regulable 0/1-10v/Dali/Push - Vidrio Matizado Dimmable 0/1-10v/Dali/Push - Frosted Glass	8435493729152	888,00
25955219081	Regulable 0/1-10v/Dali/Push - Vidrio Verde Dimmable 0/1-10v/Dali/Push - Green Glass	8435493729190	888,00
25955219086	Regulable 0/1-10v/Dali/Push - Vidrio Azul Dimmable 0/1-10v/Dali/Push - Blue Glass	8435493730233	888,00
25955219121	Regulable 0/1-10v/Dali/Push - Policarbonato Opal Dimmable 0/1-10v/Dali/Push - Opal Polycarbonate	8435493725567	837,00

## Descripción lámpara Drop / Lamps description Drop:

25955219056	Regulable 0/1-10v/Dali/Push - Vidrio Transparente Dimmable 0/1-10v/Dali/Push - Transparent Glass	8435493729169	888,00
25955219057	Regulable 0/1-10v/Dali/Push - Vidrio Matizado Dimmable 0/1-10v/Dali/Push - Frosted Glass	8435493729961	888,00
25955219058	Regulable 0/1-10v/Dali/Push - Vidrio Verde Dimmable 0/1-10v/Dali/Push - Green Glass	8435493729176	888,00
25955219059	Regulable 0/1-10v/Dali/Push - Vidrio Azul Dimmable 0/1-10v/Dali/Push - Blue Glass	8435493729183	888,00

Familia / Family: Drip/Drop Linear

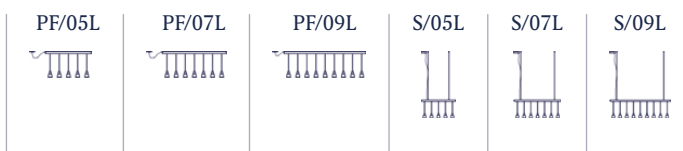



# Drip/Drop Linear S/07L

Diseño / Design:  
Christophe Mathieu / 2017

Tipología: Suspensión  
Typology: Pendant Lamp

Ambiente: Interior  
Environment: Indoor

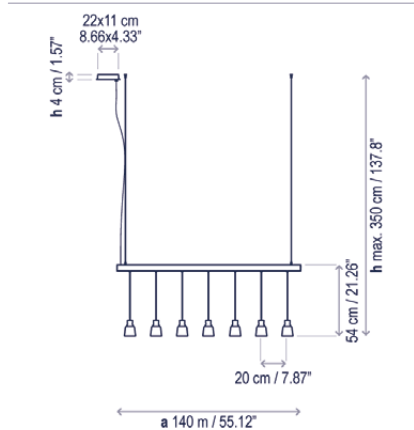

## Descripción técnica / Technical description:

Peso Neto: 1,99 kg  
Net Weight: 1,99 kg

1 Caja/Box | 40 x 40 x 25 cm | 0,04 m<sup>3</sup>  
Peso bruto / Gross Weight: 1,75 kg

1 Tubo/Tube | 187 x Ø9 cm | 0,0119 m<sup>3</sup>  
Peso bruto / Gross Weight: 2,22 kg

Materiales: Aluminio, Hierro, Policarbonato  
Materials: Aluminum, Iron, Polycarbonate

Acabado estructura color ébano negro  
Structure finish: ebony black

Personalizable  
Customizable

Certificaciones  
Certifications

Recambios / Spare parts:

DRIP  
R2599438 Vidrio transparente / Transparent glass  
R2599439 Vidrio matizado / Frosted glass  
R2599481 Vidrio verde / Green glass  
R2599486 Vidrio azul / Blue glass  
R259124 Policarbonato Opal/Opal Polycarbonate  
DROP  
R2590356 Vidrio transparente / Transparent glass  
R2590357 Vidrio matizado / Frosted glass  
R2590358 Vidrio verde / Green glass  
R2590359 Vidrio azul / Blue glass

## Descripción lámpara Drip / Lamps description Drip:

230V 50Hz IP-20 0/1-10V / DALI / PUSH 19,6 W LED / CRI: 90 / 2700°K  
2604 lm fuente de luz / light source

Ref	Acabados / Finishing	Ean13	Euros
25957219038	Regulable 0/1-10v/Dali/Push - Vidrio Transparente Dimmable 0/1-10v/Dali/Push - Transparent Glass	8435493729213	1.064,00
25957219039	Regulable 0/1-10v/Dali/Push - Vidrio Matizado Dimmable 0/1-10v/Dali/Push - Frosted Glass	8435493729220	1.064,00
25957219081	Regulable 0/1-10v/Dali/Push - Vidrio Verde Dimmable 0/1-10v/Dali/Push - Green Glass	8435493729275	1.064,00
25957219086	Regulable 0/1-10v/Dali/Push - Vidrio Azul Dimmable 0/1-10v/Dali/Push - Blue Glass	8435493729282	1.064,00
25957219121	Regulable 0/1-10v/Dali/Push - Policarbonato Opal Dimmable 0/1-10v/Dali/Push - Opal Polycarbonate	8435493726533	991,00

## Descripción lámpara Drop / Lamps description Drop:

25957219056	Regulable 0/1-10v/Dali/Push - Vidrio Transparente Dimmable 0/1-10v/Dali/Push - Transparent Glass	8435493729237	1.064,00
25957219057	Regulable 0/1-10v/Dali/Push - Vidrio Matizado Dimmable 0/1-10v/Dali/Push - Frosted Glass	8435493729244	1.064,00
25957219058	Regulable 0/1-10v/Dali/Push - Vidrio Verde Dimmable 0/1-10v/Dali/Push - Green Glass	8435493729251	1.064,00
25957219059	Regulable 0/1-10v/Dali/Push - Vidrio Azul Dimmable 0/1-10v/Dali/Push - Blue Glass	8435493729268	1.064,00

## Familia / Family: Drip/Drop Linear

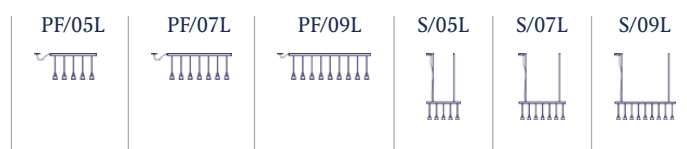

# Drip/Drop Linear S/09L

Diseño / Design:  
Christophe Mathieu / 2017

Tipología: Suspensión  
Typology: Pendant Lamp

Ambiente: Interior  
Environment: Indoor

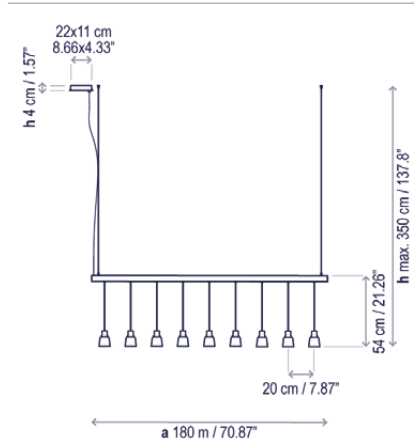

## Descripción técnica / Technical description:

Peso Neto: 2,55 kg  
Net Weight: 2,55 kg

1 Caja/Box | 47 x 47 x 37 cm | 0,0817 m<sup>3</sup>  
Peso bruto / Gross Weight: 1,93 kg

1 Tubo/Tube | 227 x Ø9 cm | 0,0144 m<sup>3</sup>  
Peso bruto / Gross Weight: 2,77 kg

Materiales: Aluminio, Hierro, Policarbonato  
Materials: Aluminum, Iron, Polycarbonate

Acabado estructura color ébano negro  
Structure finish: ebony black

Personalizable  
Customizable

Certificaciones  
Certifications

## Recambios / Spare parts:

DRIP  
R2599438 Vidrio transparente / Transparent glass  
R2599439 Vidrio matizado / Frosted glass  
R2599481 Vidrio verde / Green glass  
R2599486 Vidrio azul / Blue glass  
R259124 Policarbonato Opal/Opal Polycarbonate

DROP  
R2590356 Vidrio transparente / Transparent glass  
R2590357 Vidrio matizado / Frosted glass  
R2590358 Vidrio verde / Green glass  
R2590359 Vidrio azul / Blue glass

## Descripción lámpara Drip / Lamps description Drip:

230V 50Hz IP-20 0/1-10V / DALI / PUSH 25,2 W LED / CRI: 90 / 2700°K  
3348 lm fuente de luz / light source

Ref	Acabados / Finishing	Ean13	Euros
25959219038	Regulable 0/1-10v/Dali/Push - Vidrio Transparente Dimmable 0/1-10v/Dali/Push - Transparent Glass	8435493729299	1.167,00
25959219039	Regulable 0/1-10v/Dali/Push - Vidrio Matizado Dimmable 0/1-10v/Dali/Push - Frosted Glass	8435493729305	1.167,00
25959219081	Regulable 0/1-10v/Dali/Push - Vidrio Verde Dimmable 0/1-10v/Dali/Push - Green Glass	8435493729343	1.167,00
25959219086	Regulable 0/1-10v/Dali/Push - Vidrio Azul Dimmable 0/1-10v/Dali/Push - Blue Glass	8435493729978	1.167,00
25959219121	Regulable 0/1-10v/Dali/Push - Policarbonato Opal Dimmable 0/1-10v/Dali/Push - Opal Polycarbonate	8435493726724	1.069,00

## Descripción lámpara Drop / Lamps description Drop:

25959219056	Regulable 0/1-10v/Dali/Push - Vidrio Transparente Dimmable 0/1-10v/Dali/Push - Transparent Glass	8435493729312	1.167,00
25959219057	Regulable 0/1-10v/Dali/Push - Vidrio Matizado Dimmable 0/1-10v/Dali/Push - Frosted Glass	8435493729329	1.167,00
25959219058	Regulable 0/1-10v/Dali/Push - Vidrio Verde Dimmable 0/1-10v/Dali/Push - Green Glass	8435493730387	1.167,00
25959219059	Regulable 0/1-10v/Dali/Push - Vidrio Azul Dimmable 0/1-10v/Dali/Push - Blue Glass	8435493729336	1.167,00

## Familia / Family: Drip/Drop Linear

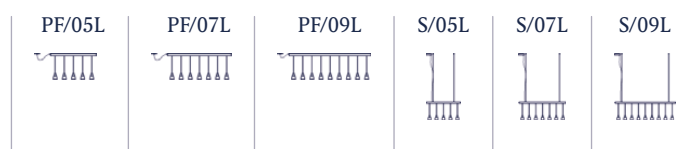



# Elea PF/55

Diseño / Design:  
Joana Bover / 2013

Tipología: Plafón  
Typology: Ceiling lamp

Ambiente: Interior  
Environment: Indoor

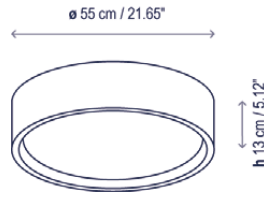

## Descripción técnica / Technical description:

Peso Neto: 7,5 kg  
Net Weight: 7,5 kg

1 Caja/Box | 67 x 67 x 25 cm | 0,1122 m<sup>3</sup>  
Peso bruto / Gross Weight: 10,17 kg

Materiales: Poliuretano lacado semi-mate  
Materials: Semi-matte lacquer polyurethane

\*Atención: El acabado ha sido modificado.  
Acabados laca brillante consultar disponibilidad y precio.

\*Attention: This finish has been modified. For brilliant lacquer finishes, please consult with us availability and price.

Difusor inferior: Cristal óptico  
Lower diffuser: Optical glass

Luz directa e indirecta  
Direct and indirect diffused light

Personalizable: acabado  
Customizable: finishing

Bombillas no incluidas  
Bulbs not included

Certificaciones  
Certifications

Recambios / Spare parts:

R51326DIF Difusor inferior / Bottom diffuser

## Descripción lámpara / Lamps description:

230V 50Hz | IP-20 | 4 x 22 W CFL E-27 | 4 x 6 W LED E-27 P45

Ref	Acabados / Finishing	Ean13	Euros
5102324122	Blanco Lacado Semi-Mate White Semi-Matte Lacquer	8435493725314	584,00
5102324123	Negro Lacado Semi-Mate Black Semi-Matte Lacquer	8435493725956	606,00

## Descripción lámpara / Lamps description:

120-277V 50/60Hz | IP-20 | TRIAC 34 W LED / CRI: 90 / 2700°K  
2686 lm fuente de luz / light source

Ref	Acabados / Finishing	Ean13	Euros
7102324122	LED Dimable TRIAC Blanco Lacado Semi-Mate LED TRIAC Dimmable White Semi-Matte Lacquer	8435493725321	691,00
7102324123	LED Dimable TRIAC Negro Lacado Semi-Mate LED TRIAC Dimmable Black Semi-Matte Lacquer	8435493725963	713,00

## Familia / Family: Elea



# Elea PF/85

Diseño / Design:  
Joana Bover / 2013

Tipología: Plafón  
Typology: Ceiling lamp

Ambiente: Interior  
Environment: Indoor

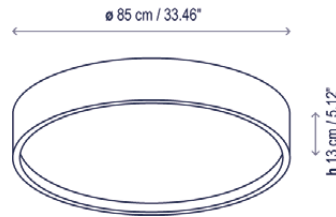

## Descripción técnica / Technical description:

Peso Neto: 18,2 kg  
Net Weight: 18,2 kg

1 Caja/Box | 91 x 92 x 26 cm | 0,2177 m<sup>3</sup>  
Peso bruto / Gross Weight: 24 kg

Materiales: Poliuretano lacado semi-mate  
Materials: Semi-matte lacquer polyurethane

\*Atención: El acabado ha sido modificado.  
Acabados laca brillante consultar disponibilidad y precio.  
\*Attention: This finish has been modified. For brilliant lacquer finishes, please consult with us availability and price

Difusor inferior: Cristal óptico  
Lower diffuser: Optical glass

Luz directa e indirecta  
Direct and indirect diffused light

Personalizable: acabado  
Customizable: finishing

Bombillas no incluidas  
Bulbs not included

Certificaciones  
Certifications

Recambios / Spare parts:

R51324DIF Difusor / Diffuser

## Descripción lámpara / Lamps description:

230V 50Hz | IP-20 | DALI\* 4 x 55 W 2G11

Ref	Acabados / Finishing	Ean13	Euros
5103324122	Blanco Lacado Semi-Mate White Semi-Matte Lacquer	8435493725420	1.069,00
5103324123	Negro Lacado Semi-Mate Black Semi-Matte Lacquer	8435493725529	1.108,00
*D5103324122	Regulable Sistema DALI Blanco Lacado Semi-Mate DALI Dimming System White Semi-Matte Lacquer	8435493725536	1.180,00
*D5103324123	Regulable Sistema DALI Negro Lacado Semi-Mate DALI Dimming System Black Semi-Matte Lacquer	8435493725543	1.219,00

Familia / Family: Elea

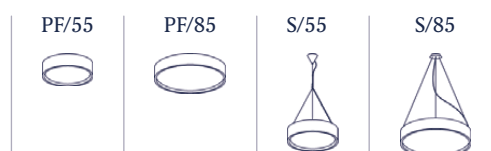

# Elea S/55

Diseño / Design:  
Joana Bover / 2013

Tipología: Suspensión  
Typology: Pendant lamp

Ambiente: Interior  
Environment: Indoor

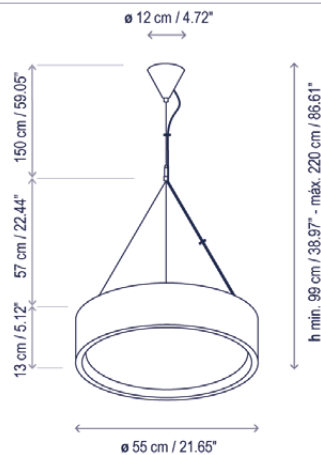

## Descripción técnica / Technical description:

Peso Neto: 8,35 kg  
Net Weight: 8,35 kg

1 Caja/Box | 67 x 67 x 25 cm | 0,1122 m<sup>3</sup>  
Peso bruto / Gross Weight: 11,66 kg

Materiales: Poliuretano lacado semi-mate  
Materials: Semi-matte lacquer polyurethane

\*Atención: El acabado ha sido modificado.  
Acabados laca brillante consultar disponibilidad y precio.

\*Attention: This finish has been modified. For brilliant lacquer finishes, please consult with us availability and price

(E27) Difusor superior e inferior: Cristal óptico  
(E27) Upper and lower diffusers: Optical glass

(LED) Difusor superior: Policarbonato  
Difusor inferior: Cristal óptico  
(LED) Upper diffuser: Polycarbonate  
Lower diffuser: Optical glass

Luz directa e indirecta  
Direct and indirect diffused light

Cable eléctrico transparente. Cable tensor acero inoxidable.  
Transparent electrical cable. Stainless steel tensor cable.

Personalizable: acabado  
Customizable: finishing

Bombillas no incluidas  
Bulbs not included

Certificaciones  
Certifications

Recambios / Spare parts:

R41326DIF Difusor superior / Upper diffuser  
R51324DIF Difusor / Diffuser

## Descripción lámpara / Lamps description:

230V 50Hz | IP-20 | 4 x 46 W EcoClassic P45 E-27 | 4 x 22 W CFL E-27 | 4 x 6 W LED P45 E-27

Ref	Acabados / Finishing	Ean13	Euros
4102324122	Blanco Lacado Semi-Mate White Semi-Matte Lacquer	8435493725550	666,00
4102324123	Negro Lacado Semi-Mate Black Semi-Matte Lacquer	8435493725703	687,00

## Descripción lámpara / Lamps description:

120-277V 50/60Hz | IP-20 | 34 W LED / CRI: 90 / 2700°K  
2686 lm fuente de luz / light source

Ref	Acabados / Finishing	Ean13	Euros
6102324122	LED Dimable TRIAC Blanco Lacado Semi-Mate LED TRIAC Dimmable White Semi-Matte Lacquer	8435493725758	726,00
6102324123	LED Dimable TRIAC Negro Lacado Semi-Mate LED TRIAC Dimmable Black Semi-Matte Lacquer	8435493725765	747,00

Familia / Family: Elea

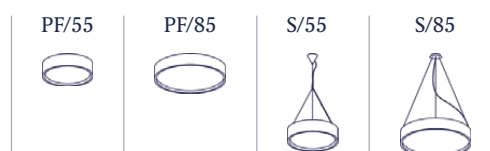

# Elea S/85

Diseño / Design:  
Joana Bover / 2013

Tipología: Suspensión  
Typology: Pendant lamp

Ambiente: Interior  
Environment: Indoor

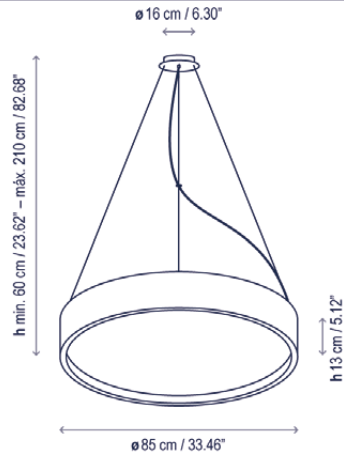

## Descripción técnica / Technical description:

Peso Neto: 17,73 kg  
Net Weight: 17,73 kg

1 Caja/Box | 91 x 92 x 26 cm | 0,2177 m<sup>3</sup>  
Peso bruto / Gross Weight: 23 kg

Materiales: Poliuretano lacado semi-mate  
Materials: Semi-matte lacquer polyurethane

\*Atención: El acabado ha sido modificado.  
Acabados laca brillante consultar disponibilidad y precio.  
\*Attention: This finish has been modified. For brilliant lacquer finishes, please consult with us availability and price

Difusor superior e inferior: Cristal óptico  
Upper and lower diffusers: Optical glass

Luz directa e indirecta  
Direct and indirect diffused light

Cable eléctrico transparente. Cable tensor acero inoxidable.  
Transparent electrical cable. Stainless steel tensor cable.

Personalizable: acabado  
Customizable: finishing

Bombillas no incluidas  
Bulbs not included

Certificaciones  
Certifications

Recambios / Spare parts:

R41324DIF Difusor superior / Upper diffuser  
R51324DIF Difusor inferior / Bottom diffuser  
R907001 Manguera 3x0,75 / Cable 3x0,75  
R907010 Manguera 5x0,75 / Cable 5x0,75

## Descripción lámpara / Lamps description:

230V 50Hz | IP-20 | DALI\* 4 x 55 W 2G11

Ref	Acabados / Finishing	Ean13	Euros
4103324122	Blanco Lacado Semi-Mate White Semi-Matte Lacquer	8435493725819	1.138,00
4103324123	Negro Lacado Semi-Mate Black Semi-Matte Lacquer	8435493725789	1.232,00
*D4103324122	Regulable Sistema DALI Blanco Lacado Semi-Mate DALI Dimming System White Semi-Matte Lacquer	8435493725796	1.391,00
*D4103324123	Regulable Sistema DALI Negro Lacado Semi-Mate DALI Dimming System Black Semi-Matte Lacquer	8435493725802	1.524,00

Familia / Family: Elea



# Elipse S/30

Diseño / Design:

Alex Fernández Camps | Gonzalo Milà / 2011

Tipología: Suspensión

Typology: Pendant lamp

Ambiente: Interior

Environment: Indoor

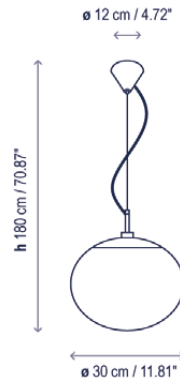

## Descripción técnica / Technical description:

Peso Neto: 1,63 kg  
Net Weight: 1,63 kg

1 Caja/Box | 47 x 47 x 37 cm | 0,0817 m<sup>3</sup>  
Peso bruto / Gross Weight: 3,2 kg

Materiales: Polietileno de media densidad  
Materials: Medium density polyethylene

Fuente de luz protegida por globo de polietileno y protección UV.  
Light source protected by UV resistant polyethylene globe.

Cable eléctrico transparente. Cable tensor acero inoxidable.  
Transparent electrical cable. Stainless steel tensor cable.

Personalizable: acabado  
Customizable: finishing

Bombillas no incluidas  
Bulbs not included

Certificaciones  
Certifications

## Descripción lámpara / Lamps description:

230V 50Hz | IP-20 | 2 x 22 W CFL E-27 | 2 x 9 W LED E-27 A60

Ref	Acabados / Finishing	Ean13	Euros
4032301	Blanco White	8436544890463	330,00
4032305	Níquel Satinado Satin Nickel	8436544890487	330,00

## Family / Familia: Elipse

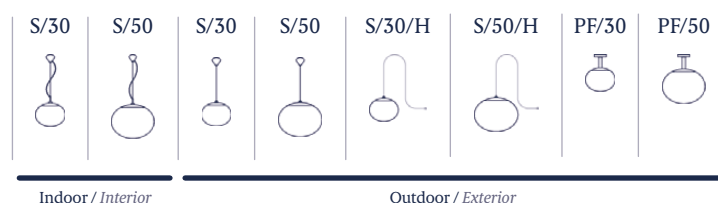

# Elipse S/50

Diseño / Design:

Alex Fernández Camps | Gonzalo Milà / 2011

Tipología: Suspensión

Typology: Pendant lamp

Ambiente: Interior

Environment: Indoor

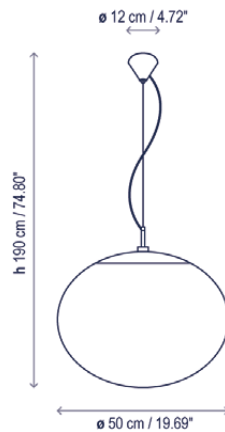

## Descripción técnica / Technical description:

Peso Neto: 3,49 kg  
Net Weight: 3,49 kg

1 Caja/Box | 61 x 61 x 50 cm | 0,1861 m<sup>3</sup>  
Peso bruto / Gross Weight: 6,2 kg

Materiales: Polietileno de media densidad  
Materials: Medium density polyethylene

Fuente de luz protegida por globo de polietileno y protección UV.  
Light source protected by UV resistant polyethylene globe.

Cable eléctrico transparente. Cable tensor acero inoxidable.  
Transparent electrical cable. Stainless steel tensor cable.

Personalizable: acabado  
Customizable: finishing

Bombillas no incluidas  
Bulbs not included

Certificaciones  
Certifications

## Descripción lámpara / Lamps description:

230V 50Hz | IP-20 | 2 x 30 W CFL E-27 | 2 x 9 W LED E-27 A60

Ref	Acabados / Finishing	Ean13	Euros
4132301	Blanco White	8436544890470	387,00
4132305	Níquel Satinado Satin Nickel	8436544890494	387,00

## Family / Familia: Elipse

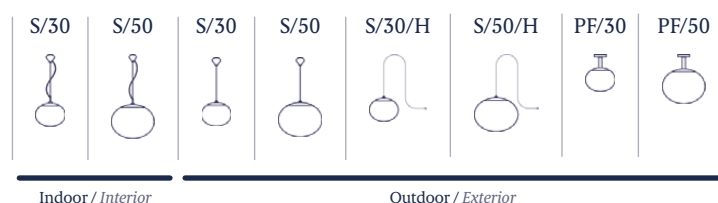



# Elipse S/30 Outdoor

Diseño / Design:

Alex Fernández Camps | Gonzalo Milà / 2017

Tipología: Suspensión

Typology: Pendant lamp

Ambiente: Exterior

Environment: Outdoor

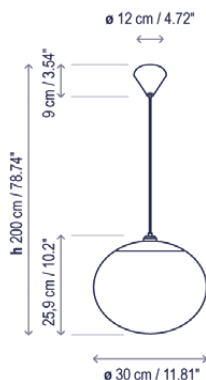

## Descripción técnica / Technical description:

Peso Neto: 2,19 kg  
Net Weight: 2,19 kg

1 Caja/Box | 37 x 47 x 47 cm | 0,0817 m<sup>3</sup>  
Peso bruto / Gross Weight: 3,58 kg

Materiales: Latón, Hierro, Polietileno de media densidad.

Materials: Brass, Iron, Medium density polyethylene.

Estructuras de metal acabadas con cataforesis y pintura de poliéster epoxi.

Metal surfaces coated with cataphoresis and epoxy polyester paint.

Fuente de luz protegida por globo de polietileno y protección UV.

Light source protected by UV resistant polyethylene globe.

Cable sin interruptor de neopreno negro resistente al agua.

Black waterproof neoprene cable without switch.

Personalizable: acabado

Customizable: finishing

Bombillas no incluidas

Bulbs not included

Certificaciones

Certifications

## Descripción lámpara / Lamps description:

230V 50Hz | IP-66 | 2 x 14 W CFL E-27 | 2 x 6 W LED E-27 P45

Ref	Acabados / Finishing	Ean13	Euros
3230120213	Blanco White	8435493722269	339,00

## Family / Familia: Elipse

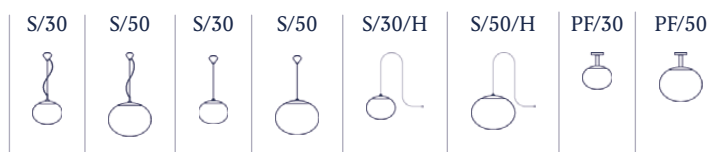

Indoor / Interior

Outdoor / Exterior



# Elipse S/50 Outdoor

Diseño / Design:

Alex Fernández Camps | Gonzalo Milà / 2017

Tipología: Suspensión

Typology: Pendant lamp

Ambiente: Exterior

Environment: Outdoor

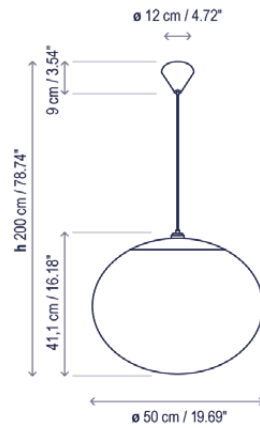

## Descripción técnica / Technical description:

Peso Neto: 3,85 kg  
Net Weight: 3,85 kg

1 Caja/Box | 50 x 61 x 61 cm | 0,1377 m<sup>3</sup>  
Peso bruto / Gross Weight: 6,65 kg

Materiales: Latón, Hierro, Polietileno de media densidad.

Materials: Brass, Iron, Medium density polyethylene.

Estructuras de metal acabadas con cataforesis y pintura de poliéster epoxi.

Metal surfaces coated with cathoresis and epoxy polyester paint.

Fuente de luz protegida por globo de polietileno y protección UV.

Light source protected by UV resistant polyethylene globe.

Cable sin interruptor de neopreno negro resistente al agua.

Black waterproof neoprene cable without switch.

Personalizable: acabado

Customizable: finishing

Bombillas no incluidas

Bulbs not included

Certificaciones  
Certifications



## Descripción lámpara / Lamps description:

230V 50Hz | IP-66 | 2 x 14 W CFL E-27 | 2 x 6 W LED E-27 P45

Ref	Acabados / Finishing	Ean13	Euros
3230220213	Blanco White	8435493722283	397,00

## Family / Familia: Elipse

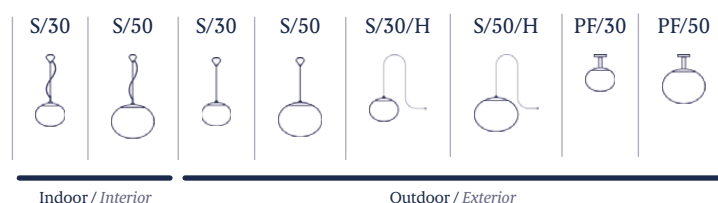

# Elipse S/30/H Outdoor

Diseño / Design:

Alex Fernández Camps | Gonzalo Milà / 2011

Tipología: Suspensión

Typology: Pendant lamp

Ambiente: Exterior

Environment: Outdoor

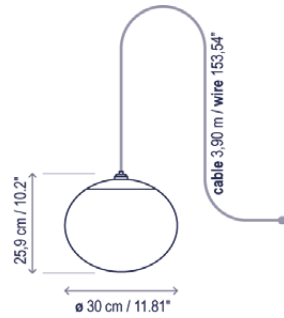

## Descripción técnica / Technical description:

 **Peso Neto: 2,19 kg**  
Net Weight: 2,19 kg

 **1 Caja/Box | 47 x 47 x 37 cm | 0,0817 m<sup>3</sup>**  
Peso bruto / Gross Weight: 3,58 kg

**Materiales: Latón, Hierro, Aluminio, Polietileno de media densidad.**

*Materials: Brass, Iron, Aluminum, Medium density polyethylene.*

**Estructuras de metal acabadas con cataforesis y pintura de poliéster epoxi.**

*Metal surfaces coated with cathaphoresis and epoxy polyester paint.*

**Fuente de luz protegida por globo de polietileno y protección UV.**

*Light source protected by UV resistant polyethylene globe.*

**Cable sin interruptor de neopreno negro resistente al agua.**

*Black waterproof neoprene cable without switch.*

**Incluye accesorio de goma que facilita la instalación temporal de la luminaria en diferentes espacios.**

*Includes a hooked rubber accessory that facilitates the temporary installation to many different placements.*

**Personalizable: acabado**

*Customizable: finishing*

**Bombillas no incluidas**

*Bulbs not included*

**Certificaciones**  
Certifications



## Descripción lámpara / Lamps description:



Ref	Acabados / Finishing	Ean13	Euros
3231120213	Blanco White	8435493722276	281,00

## Family / Familia: Elipse

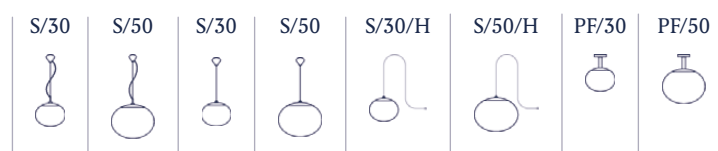

Indoor / Interior

Outdoor / Exterior

# Elipse S/50/H Outdoor

Diseño / Design:

Alex Fernández Camps | Gonzalo Milà / 2011

Tipología: Suspensión

Typology: Pendant lamp

Ambiente: Exterior

Environment: Outdoor

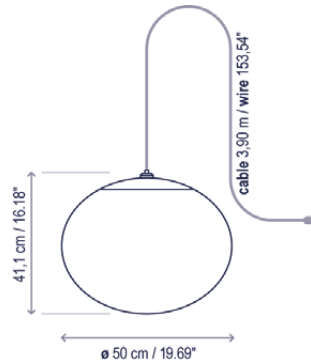

## Descripción técnica / Technical description:

Peso Neto: 3,85 kg  
Net Weight: 3,85 kg

1 Caja/Box | 61 x 61 x 50 cm | 0,1377 m<sup>3</sup>  
Peso bruto / Gross Weight: 6,65 kg

Materiales: Latón, Hierro, Aluminio,  
Polietileno de media densidad.

Materials: Brass, Iron, Aluminum, Medium  
density polyethylene.

Estructuras de metal acabadas con cataforesis  
y pintura de poliéster epoxi.

Metal surfaces coated with cathaphoresis and  
epoxy polyester paint.

Fuente de luz protegida por globo de  
polietileno y protección UV.

Light source protected by UV resistant  
polyethylene globe.

Cable sin interruptor de neopreno negro  
resistente al agua.

Black waterproof neoprene cable without  
switch.

Incluye accesorio de goma que facilita la  
instalación temporal de la luminaria en  
diferentes espacios.

Includes a hooked rubber accessory that  
facilitates the temporary installation to many  
different placements.

Personalizable: acabado

Customizable: finishing

Bombillas no incluidas

Bulbs not included

Certificaciones  
Certifications



## Descripción lámpara / Lamps description:

230V  
50Hz | IP-66 | 2 x 14 W CFL E-27 | 2 x 6 W LED E-27 P45

Ref	Acabados / Finishing	Ean13	Euros
3231220213	Blanco White	8435493722290	339,00

## Family / Familia: Elipse

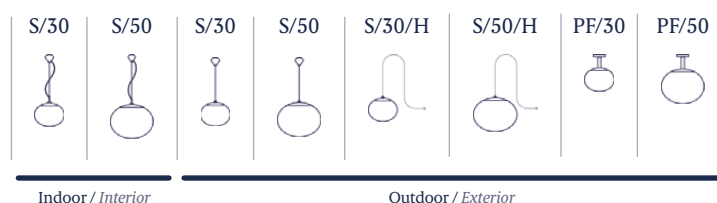

# Elipse PF/30 Outdoor

Diseño / Design:

Alex Fernández Camps | Gonzalo Milà / 2011

Tipología: Plafón

Typology: Ceiling lamp

Ambiente: Exterior

Environment: Outdoor

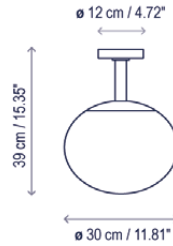

## Descripción técnica / Technical description:

Peso Neto: 2,19 kg  
Net Weight: 2,19 kg

1 Caja/Box | 61 x 61 x 40 cm | 0,1674 m<sup>3</sup>  
Peso bruto / Gross Weight: 3,58 kg

Materiales: Latón, Hierro, Aluminio,  
Polietileno de media densidad.

Materials: Brass, Iron, Aluminum, Medium  
density polyethylene.

Estructuras de metal acabadas con cataforesis  
y pintura de poliéster epoxi.

Metal surfaces coated with cataphoresis and  
epoxy polyester paint.

Fuente de luz protegida por globo de  
polietileno y protección UV.

Light source protected by UV resistant  
polyethylene globe.

Personalizable: acabado

Customizable: finishing

Bombillas no incluidas

Bulbs not included

Certificaciones  
Certifications



## Descripción lámpara / Lamps description:

230V  
50Hz | IP-66 | 2 x 14 W CFL E-27 | 2 x 6 W LED E-27 P45

Ref	Acabados / Finishing	Ean13	Euros
3230110013	Blanco White	8435493722368	334,00

## Family / Familia: Elipse

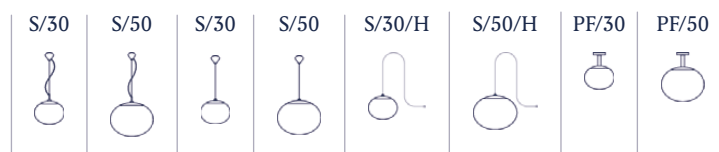

Indoor / Interior

Outdoor / Exterior

# Elipse PF/50 Outdoor

Diseño / Design:

Alex Fernández Camps | Gonzalo Milà / 2011

Tipología: Plafón

Typology: Ceiling lamp

Ambiente: Exterior

Environment: Outdoor

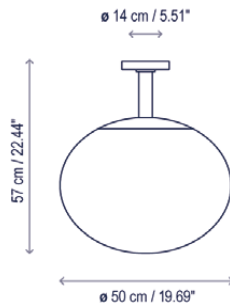

## Descripción técnica / Technical description:



Peso Neto: 3,85 kg  
Net Weight: 3,85 kg



1 Caja/Box | 61 x 61 x 50 cm | 0,1377 m<sup>3</sup>  
Peso bruto / Gross Weight: 6,65 kg

Materiales: Latón, Hierro, Aluminio,  
Polietileno de media densidad.

Materials: Brass, Iron, Aluminum, Medium  
density polyethylene.

Estructuras de metal acabadas con cataforesis  
y pintura de poliéster epoxi.

Metal surfaces coated with cataphoresis and  
epoxy polyester paint.

Fuente de luz protegida por globo de  
polietileno y protección UV.

Light source protected by UV resistant  
polyethylene globe.

Personalizable: acabado  
Customizable: finishing

Bombillas no incluidas  
Bulbs not included

Certificaciones  
Certifications



## Descripción lámpara / Lamps description:



230V  
50Hz

IP-66



2 x 14 W CFL E-27



2 x 6 W LED E-27 P45

Ref	Acabados / Finishing	Ean13	Euros
3230210013	Blanco White	8435493722399	436,00

## Family / Familia: Elipse

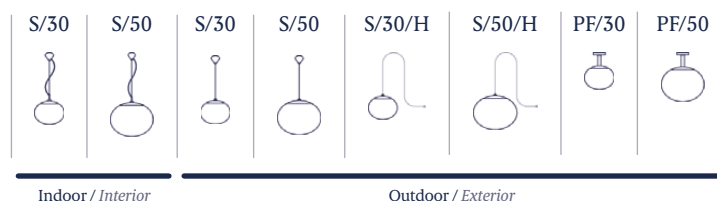

# Ema M/53

Diseño / Design:  
Joana Bover / 2004

Tipología: Mesa  
Typology: Table lamp

Ambiente: Interior  
Environment: Indoor

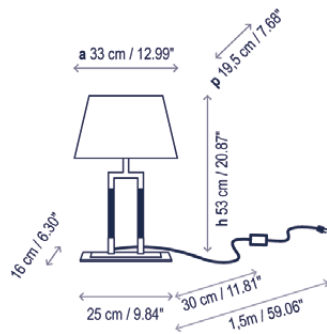

## Descripción técnica / Technical description:

Peso Neto: 3,42 kg  
Net Weight: 3,42 kg

1 Caja/Box | 61 x 61 x 40 cm | 0,1488 m<sup>3</sup>  
Peso bruto / Gross Weight: 6,46 kg

Materiales: Latón, Acero inoxidable 304, Piel  
Materials: Brass, 304 Stainless steel, Leather

Cable eléctrico negro  
Black electrical cable

Hilo incandescente pantalla / Shade GWF1  
Cotonet / Cotton: 750°

Personalizable  
Customizable

Bombillas no incluidas  
Bulbs not included

Certificaciones  
Certifications

## Descripción lámpara / Lamps description:

230V 50HZ | IP-20 | 1 x 46 W EcoClassic P45 E-27 | 1 x 6 W LED P45 E-27

Ref	Acabados / Finishing	Ean13	Euros
2119405/P479	Níquel Satinado - Pantalla Cotonet Satin Nickel - Cotton Shade	8435493704272	352,00
2119460/P479	Níquel Piel Oscura - Pantalla Cotonet Nickel Dark Leather - Cotton Shade	8435493704296	415,00

Familia / Family: Ema





# Ema P/157

Diseño / Design:  
Joana Bover / 2004

Tipología: Pie  
Typology: Floor lamp

Ambiente: Interior  
Environment: Indoor

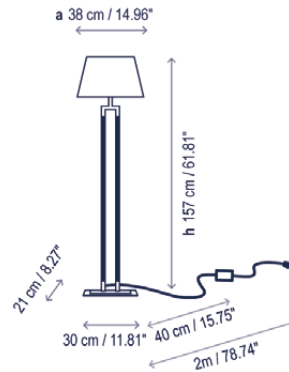

## Descripción técnica / Technical description:

Peso Neto: 5,64 kg  
Net Weight: 5,64 kg

2 Cajas / 2 Boxes:

1 Caja/Box | 35 x 34 x 148 cm | 0,1761 m<sup>3</sup>  
Peso bruto / Gross Weight: 8,8 kg

1 Caja/Box | 40 x 40 x 25 cm | 0,04 m<sup>3</sup>  
Peso bruto / Gross Weight: 1,05 kg

Materiales: Latón, Acero inoxidable 304, Piel  
Materials: Brass, 304 Stainless steel, Leather

Cable eléctrico negro  
Black electrical cable

Hilo incandescente pantalla / Shade GWF1  
Cottonet / Cotton: 750°

Personalizable  
Customizable

Bombillas no incluidas  
Bulbs not included

Certificaciones  
Certifications

## Descripción lámpara / Lamps description:

230V 50Hz | IP-20 | 1 x 46 W EcoClassic P45 E-27 | 1 x 11 W CFL E-27 | 1 x 6 W LED P45 E-27

Ref	Acabados / Finishing	Ean13	Euros
3019405/P481	Níquel Satinado - Pantalla Cottonet Satin Nickel - Cotton Shade	8435493707297	552,00
3019460/P481	Níquel Piel Oscura - Pantalla Cottonet Nickel Dark Leather - Cotton Shade	8435493707310	616,00

Familia / Family: Ema





# Flexo

Diseño / Design:  
Joana Bover / 2006

Tipología: Aplique  
Typology: Wall lamp

Ambiente: Interior  
Environment: Indoor

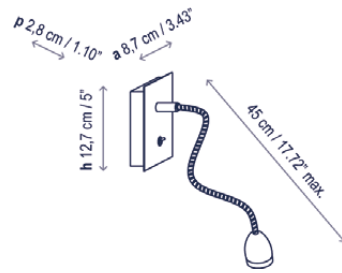

## Descripción técnica / Technical description:

Peso Neto: 0,56 kg  
Net Weight: 0,56 kg

1 Caja/Box | 18 x 18 x 32 cm | 0,0104 m<sup>3</sup>  
Peso bruto / Gross Weight: 0,84 kg

Materiales: Latón, Hierro, Aluminio  
Materials: Brass, Iron, Aluminum

Caja soporte: 6,7 x 10,6 cm  
Surface back box: 2.64" x 4.17"

Nota de uso: El flexo debe manipularse por la parte central del mismo. Manipular el flexo por los extremos puede ocasionar el deterioro de la malla.

Note of use: The flexo must be manipulated by the central part of it. Manipulating the flexo by the end can cause the mesh deterioration.

Personalizable  
Customizable

Certificaciones  
Certifications

Recambios / Spare parts:

RDRIVER Alimentador LED / LED Driver  
R25103N Cristal negro / Black glass

## Descripción lámpara / Lamps description:

230V 50HZ | IP-20 | 1,2 W LED / CRI: 90 / 2900°K  
85 lm fuente de luz / light source

Ref	Acabados / Finishing	Ean13	Euros
FL25106	Cromo Chrome	8436047301251	233,00
FL25105	Níquel Satinado Satin Nickel	8436047301268	233,00

# Flexo Lexa

Diseño / Design:  
Christophe Mathieu / 2008

Tipología: Aplique  
Typology: Wall lamp

Ambiente: Interior  
Environment: Indoor

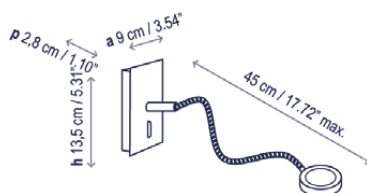

## Descripción técnica / Technical description:

 Peso Neto: 0,72 kg  
Net Weight: 0,72 kg

 1 Caja/Box | 18 x 18 x 32 cm | 0,0104 m<sup>3</sup>  
Peso bruto / Gross Weight: 1 kg

Materiales: Zamac, Latón  
Materials: Zamac, Brass

Caja soporte: 7,8 x 12 cm  
Surface back box: 3.07" x 4.72"

Nota de uso: El flexo debe manipularse por la parte central del mismo. Manipular el flexo por los extremos puede ocasionar el deterioro de la malla.

Note of use: The flexo must be manipulated by the central part of it. Manipulating the flexo by the end can cause the mesh deterioration.

Personalizable  
Customizable

Certificaciones  
Certifications  

Recambios / Spare parts:

RDRIVER Alimentador LED / LED Driver

## Descripción lámpara / Lamps description:

  230V 50Hz | IP-20 |   1,2 W LED / CRI: 90 / 2900°K  
85 lm fuente de luz / light source

Ref	Acabados / Finishing	Ean13	Euros
FL20506	Cromo Chrome	8436047307437	246,00
FL20505	Níquel Satinado Satin Nickel	8436047307420	246,00

# Fora A

Diseño / Design:

Alex Fernández Camps | Gonzalo Milà / 2010

Tipología: Aplique

Typology: Wall lamp

Ambiente: Exterior

Environment: Outdoor

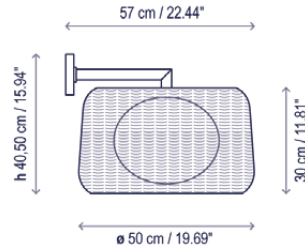

## Descripción técnica / Technical description:

Peso Neto: 4,77 kg  
Net Weight: 4,77 kg

1 Caja/Box | 61 x 61 x 50 cm | 0,1861 m<sup>3</sup>  
Peso bruto / Gross Weight: 7,15 kg

Materiales: Aluminio, Acero Inoxidable, Polietileno, Fibra Sintética.

Materials: Aluminum, Stainless steel, Polyethylene, Synthetic fiber.

Estructuras de metal acabadas con cataforesis y pintura de poliéster epoxi.

Metal surfaces coated with cathaphoresis and epoxy polyester paint.

Pantallas tejidas a mano con fibra de polietileno sintética reciclable y no tóxica. Fuente de luz protegida por globo de polietileno y protección UV.

Hand woven with a recyclable and non-toxic synthetic polyethylene fiber. Light source protected by UV resistant polyethylene globe.

Caja soporte: ø 12 cm  
Surface back box: ø 4.72"

Personalizable: consultar  
Customizable: consult

Bombillas no incluidas  
Bulbs not included

Certificaciones  
Certifications

## Descripción lámpara / Lamps description:

IP-66 2 x 22 W CFL E-27 2 x 9 W LED E-27 A60

Ref	Acabados / Finishing	Ean13	Euros
1130301/P695C	Blanco Roto - Pantalla Beige Claro* Natural White - Light Beige Shade*	8435493702810	809,00
1130303/P696C	Marrón Grafito - Pantalla Marrón Rattan* Graphite Brown - Rattan Brown Shade*	8435493702827	809,00

\*Por favor, tenga en cuenta que los tonos de color de la pantalla pueden no ser los mismos en todos los casos. / Please note that the shades may have small variations in tone.

Nota de uso: Para ambientes con alto grado de salinidad, será necesario realizar un correcto mantenimiento de la luminaria. Recomendamos limpiar con un cepillo suave y retirar la sal, el polvo, o la suciedad depositada por la humedad o el viento.

Note of use: For environments with a high salinity, proper maintenance of the luminaire will be necessary. We recommend cleaning it with a soft brush and remove salt, dust, or dirt deposited by moisture or wind.

## Familia / Family: Fora

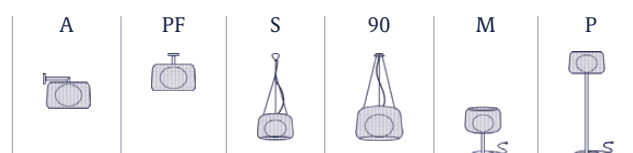

# Fora PF

Diseño / Design:

Alex Fernández Camps | Gonzalo Milà / 2010

Tipología: Plafón

Typology: Ceiling lamp

Ambiente: Exterior

Environment: Outdoor

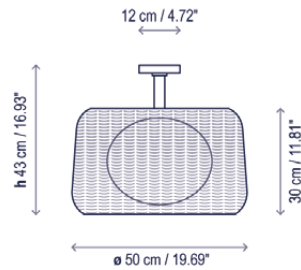

## Descripción técnica / Technical description:

**Peso Neto: 4,38 kg**  
Net Weight: 4,38 kg

**1 Caja/Box | 61 x 61 x 50 cm | 0,1861 m<sup>3</sup>**  
Peso bruto / Gross Weight: 6,76 kg

**Materiales: Aluminio, Acero Inoxidable, Polietileno, Fibra Sintética.**

*Materials: Aluminum, Stainless steel, Polyethylene, Synthetic fiber.*

**Estructuras de metal acabadas con cataforesis y pintura de poliéster epoxi.**

*Metal surfaces coated with cataphoresis and epoxy polyester paint.*

**Pantallas tejidas a mano con fibra de polietileno sintética reciclable y no tóxica. Fuente de luz protegida por globo de polietileno y protección UV.**

*Hand woven with a recyclable and non-toxic synthetic polyethylene fiber. Light source protected by UV resistant polyethylene globe.*

**Personalizable: consultar**

*Customizable: consult*

**Bombillas no incluidas**

*Bulbs not included*

**Certificaciones**  
Certifications



## Descripción lámpara / Lamps description:

230V 50Hz | IP-66 | 2 x 22 W CFL E-27 | 2 x 9 W LED E-27 A60

Ref	Acabados / Finishing	Ean13	Euros
5130301/P695C	Blanco Roto - Pantalla Beige Claro* Natural White - Light Beige Shade*	8435493713656	788,00
5130303/P696C	Marrón Grafito - Pantalla Marrón Rattan* Graphite Brown - Rattan Brown Shade*	8435493713663	788,00

\*Por favor, tenga en cuenta que los tonos de color de la pantalla pueden no ser los mismos en todos los casos. / Please note that the shades may have small variations in tone.

**Nota de uso: Para ambientes con alto grado de salinidad, será necesario realizar un correcto mantenimiento de la luminaria. Recomendamos limpiar con un cepillo suave y retirar la sal, el polvo, o la suciedad depositada por la humedad o el viento.**

*Note of use: For environments with a high salinity, proper maintenance of the luminaire will be necessary. We recommend cleaning it with a soft brush and remove salt, dust, or dirt deposited by moisture or wind.*

Familia / Family: Fora

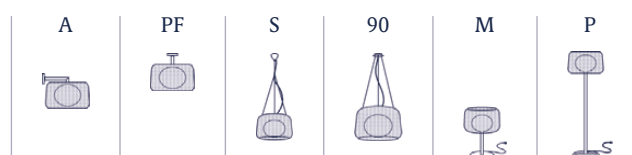

# Fora S

Diseño / Design:

Alex Fernández Camps | Gonzalo Milà / 2010

Tipología: Suspensión

Typology: Pendant lamp

Ambiente: Exterior

Environment: Outdoor

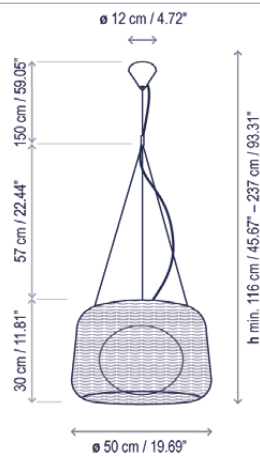

## Descripción técnica / Technical description:

**Peso Neto: 3,66 kg**  
Net Weight: 3,66 kg

**1 Caja/Box | 61 x 61 x 40 cm | 0,1488 m<sup>3</sup>**  
Peso bruto / Gross Weight: 6,5 kg

**Materiales: Aluminio, Acero Inoxidable, Polietileno, Fibra Sintética.**

*Materials: Aluminum, Stainless steel, Polyethylene, Synthetic fiber.*

**Estructuras de metal acabadas con cataforesis y pintura de poliéster epoxi.**

*Metal surfaces coated with cataphoresis and epoxy polyester paint.*

**Pantallas tejidas a mano con fibra de polietileno sintética reciclable y no tóxica. Fuente de luz protegida por globo de polietileno y protección UV.**

*Hand woven with a recyclable and non-toxic synthetic polyethylene fiber. Light source protected by UV resistant polyethylene globe.*

**Cable de neopreno negro resistente al agua. Cable tensor acero inoxidable.**

*Black waterproof neoprene cable. Stainless steel tensor cable.*

**Personalizable: consultar**

*Customizable: consult*

**Bombillas no incluidas**

*Bulbs not included*

**Certificaciones**

*Certifications*



**Recambios / Spare parts:**

R907007 Cable Neopreno / Neoprene Cable

## Descripción lámpara / Lamps description:



Ref	Acabados / Finishing	Ean13	Euros
4130301/P695C	Blanco Roto - Pantalla Beige Claro* Natural White - Light Beige Shade*	8435493710815	798,00
4130303/P696C	Marrón Grafito - Pantalla Marrón Rattan* Graphite Brown - Rattan Brown Shade*	8435493710822	798,00

**\*Por favor, tenga en cuenta que los tonos de color de la pantalla pueden no ser los mismos en todos los casos. / Please note that the shades may have small variations in tone.**

**Nota de uso: Para ambientes con alto grado de salinidad, será necesario realizar un correcto mantenimiento de la luminaria. Recomendamos limpiar con un cepillo suave y retirar la sal, el polvo, o la suciedad depositada por la humedad o el viento.**

*Note of use: For environments with a high salinity, proper maintenance of the luminaire will be necessary. We recommend cleaning it with a soft brush and remove salt, dust, or dirt deposited by moisture or wind.*

## Familia / Family: Fora

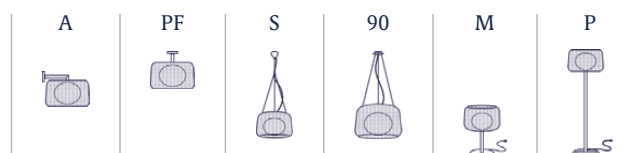

# Fora 90

Diseño / Design:

Alex Fernández Camps | Gonzalo Milà / 2010

Tipología: Suspensión

Typology: Pendant lamp

Ambiente: Exterior

Environment: Outdoor

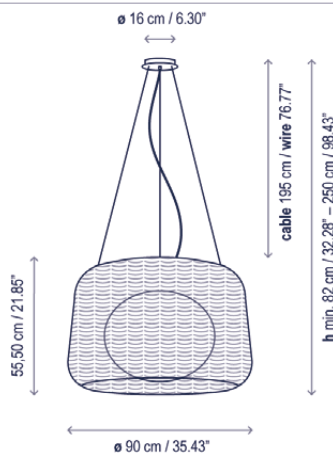

Descripción técnica / Technical description:

Peso Neto: 10 kg  
Net Weight: 10 kg

1 Caja/Box | 106 x 97 x 75 cm | 0,7712 m<sup>3</sup>  
Peso bruto / Gross Weight: 19 kg

Materiales: Aluminio, Acero Inoxidable, Polietileno, Fibra Sintética.

Materials: Aluminum, Stainless steel, Polyethylene, Synthetic fiber.

Estructuras de metal acabadas con cataforesis y pintura de poliéster epoxi.

Metal surfaces coated with cataphoresis and epoxy polyester paint.

Pantallas tejidas a mano con fibra de polietileno sintética reciclable y no tóxica. Fuente de luz protegida por globo de polietileno y protección UV.

Hand woven with a recyclable and non-toxic synthetic polyethylene fiber. Light source protected by UV resistant polyethylene globe.

Cable de neopreno negro resistente al agua. Cable tensor acero inoxidable.

Black waterproof neoprene cable. Stainless steel tensor cable.

Personalizable: consultar

Customizable: consult

Bombillas no incluidas

Bulbs not included

Certificaciones  
Certifications



Recambios / Spare parts:

R907007 Cable Neopreno / Neoprene Cable

Descripción lámpara / Lamps description:



Ref	Acabados / Finishing	Ean13	Euros
4030301/P707C	Blanco Roto - Pantalla Beige Claro* Natural White - Light Beige Shade*	8435493709895	1.168,00
4030303/P708C	Marrón Grafito - Pantalla Marrón Rattan* Graphite Brown - Rattan Brown Shade*	8435493709901	1.168,00

\*Por favor, tenga en cuenta que los tonos de color de la pantalla pueden no ser los mismos en todos los casos. / Please note that the shades may have small variations in tone.

Nota de uso: Para ambientes con alto grado de salinidad, será necesario realizar un correcto mantenimiento de la luminaria. Recomendamos limpiar con un cepillo suave y retirar la sal, el polvo, o la suciedad depositada por la humedad o el viento.

Note of use: For environments with a high salinity, proper maintenance of the luminaire will be necessary. We recommend cleaning it with a soft brush and remove salt, dust, or dirt deposited by moisture or wind.

Familia / Family: Fora

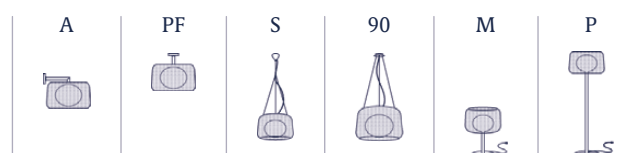



# Fora M

Diseño / Design:

Alex Fernández Camps | Gonzalo Milà / 2010

Tipología: Mesa

Typology: Table lamp

Ambiente: Exterior

Environment: Outdoor

## Descripción técnica / Technical description:

 **Peso Neto: 10,55 kg**  
Net Weight: 10,55 kg

 **1 Caja/Box | 52 x 52 x 75 cm | 0,2028 m<sup>3</sup>**  
Peso bruto / Gross Weight: 13,45 kg

**Materiales: Aluminio, Acero Inoxidable, Polietileno, Fibra Sintética.**

*Materials: Aluminum, Stainless steel, Polyethylene, Synthetic fiber.*

**Estructuras de metal acabadas con cataforesis y pintura de poliéster epoxi.**

*Metal surfaces coated with cathaphoresis and epoxy polyester paint.*

**Pantallas tejidas a mano con fibra de polietileno sintética reciclable y no tóxica. Fuente de luz protegida por globo de polietileno y protección UV.**

*Hand woven with a recyclable and non-toxic synthetic polyethylene fiber. Light source protected by UV resistant polyethylene globe.*

**Cable sin interruptor de neopreono negro resistente al agua. Consulte opciones de anclaje. Instalación eléctrica fija disponible bajo pedido.**

*Black waterproof neoprene cable without switch. Consult for fastening options. Hardwired version upon request.*

**Personalizable: consultar**

*Customizable: consult*

**Bombillas no incluidas**

*Bulbs not included*

**Certificaciones**  
Certifications

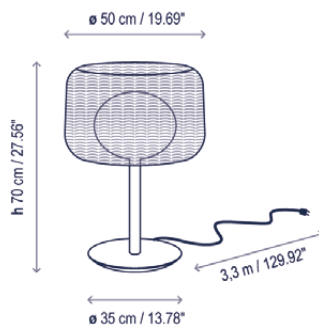

## Descripción lámpara / Lamps description:

  **230V** **50Hz** | **IP-66** |  **2 x 22 W CFL E-27** |  **2 x 9 W LED E-27 A60**

Ref	Acabados / Finishing	Ean13	Euros
2230301/P695	Blanco Roto - Pantalla Beige Claro* <i>Natural White - Light Beige Shade*</i>	8435493705286	899,00
2230303/P696	Marrón Grafito - Pantalla Marrón Rattan* <i>Graphite Brown - Rattan Brown Shade*</i>	8435493705293	899,00

**\*Por favor, tenga en cuenta que los tonos de color de la pantalla pueden no ser los mismos en todos los casos. / Please note that the shades may have small variations in tone.**

**Nota de uso: Para ambientes con alto grado de salinidad, será necesario realizar un correcto mantenimiento de la luminaria. Recomendamos limpiar con un cepillo suave y retirar la sal, el polvo, o la suciedad depositada por la humedad o el viento.**

*Note of use: For environments with a high salinity, proper maintenance of the luminaire will be necessary. We recommend cleaning it with a soft brush and remove salt, dust, or dirt deposited by moisture or wind.*

## Familia / Family: Fora

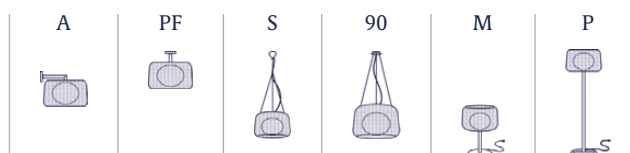

# Fora P

Diseño / Design:

Alex Fernández Camps | Gonzalo Milà / 2010

Tipología: Pie

Typology: Floor lamp

Ambiente: Exterior

Environment: Outdoor

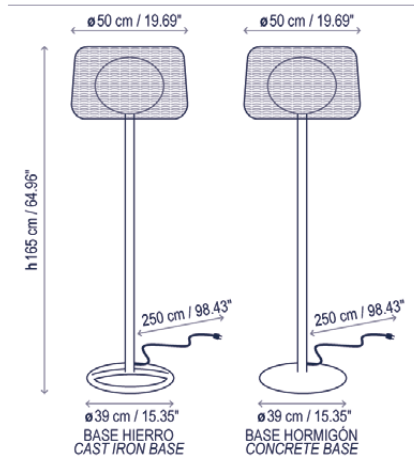

## Descripción técnica / Technical description:

**Peso Neto: 11,94 kg**  
Net Weight: 11,94 kg

**1 Caja/Box | 57 x 57 x 170 cm | 0,5523 m³**  
Peso bruto / Gross Weight: 19 kg

**Materiales: Aluminio, Acero Inoxidable, Polietileno, Fibra Sintética, Hormigón.**  
Materials: Aluminum, Stainless steel, Polyethylene, Synthetic fiber, Concrete.

**Estructuras de metal acabadas con cataforesis y pintura de poliéster epoxi.**

Metal surfaces coated with cathaphoresis and epoxy polyester paint.

**Pantallas tejidas a mano con fibra de polietileno sintética reciclable y no tóxica. Fuente de luz protegida por globo de polietileno y protección UV.**

Hand woven with a recyclable and non-toxic synthetic polyethylene fiber. Light source protected by UV resistant polyethylene globe.

**Cable sin interruptor de neopreno negro resistente al agua. Consulte opciones de anclaje al suelo. Instalación eléctrica fija disponible bajo pedido. Se aconseja base de hormigón en zonas con alto grado de salinidad o clima adverso.**

Black waterproof neoprene cable. Consult for fastening options. Hardwired version upon request. Concrete base recommended in areas with high salinity or adverse weather conditions.

**Personalizable: consultar**

Customizable: consult

**Bombillas no incluidas**

Bulbs not included

**Certificaciones**  
Certifications



## Descripción lámpara / Lamps description:

230V 50Hz | IP-66 | 2 x 22 W CFL E-27 | 2 x 9 W LED E-27 A60

Ref	Acabados / Finishing	Ean13	Euros
3130301/P695	Blanco Roto - Base Hormigón Beige Pantalla Beige Claro* Natural White - Beige Concrete Base Light Beige Shade*	8435493708034	1.093,00
3030301/P695	Blanco Roto - Base Hierro Pantalla Beige Claro* Natural White - Cast Iron Base Light Beige Shade*	8435493707877	1.070,00
3130303/P696	Marrón Grafito - Base Hormigón Gris Pantalla Marrón Rattan* Graphite Brown - Grey Concrete Base Rattan Brown Shade*	8435493708041	1.093,00
3030303/P696	Marrón Grafito - Base Hierro Pantalla Marrón Rattan* Graphite Brown - Cast Iron Base Rattan Brown Shade*	8435493707884	1.070,00

\*Por favor, tenga en cuenta que los tonos de color de la pantalla pueden no ser los mismos en todos los casos. / Please note that the shades may have small variations in tone.

**Nota de uso: Para ambientes con alto grado de salinidad, será necesario realizar un correcto mantenimiento de la luminaria. Recomendamos limpiar con un cepillo suave y retirar la sal, el polvo, o la suciedad depositada por la humedad o el viento.**

Note of use: For environments with a high salinity, proper maintenance of the luminaire will be necessary. We recommend cleaning it with a soft brush and remove salt, dust, or dirt deposited by moisture or wind.

## Familia / Family: Fora

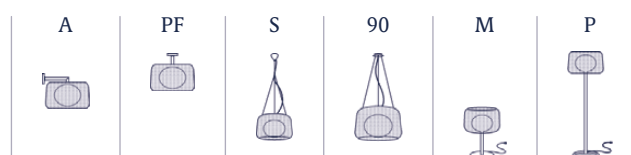

# Garota A/01 Outdoor

Diseño / Design:

Alex Fernández Camps | Gonzalo Milà / 2015

Tipología: Aplique

Typology: Wall lamp

Ambiente: Exterior

Environment: Outdoor

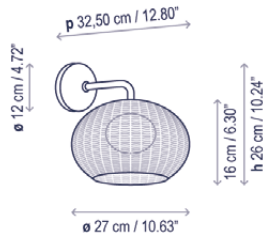

## Descripción técnica / Technical description:

Peso Neto: 1,34 kg  
Net Weight: 1,34 kg

1 Caja/Box | 28 x 28 x 41 cm | 0,0321 m<sup>3</sup>  
Peso bruto / Gross Weight: 1,91 kg

Materiales: Aluminio, Acero Inoxidable, Polietileno, Fibra Sintética.

Materials: Aluminum, Stainless steel, Polyethylene, Synthetic fiber.

Estructuras de metal acabadas con cataforesis y pintura de poliéster epoxi.

Metal surfaces coated with cataphoresis and epoxy polyester paint.

Pantallas tejidas a mano con fibra de polietileno sintética reciclable y no tóxica. Fuente de luz protegida por globo de polietileno y protección UV.

Hand woven with a recyclable and non-toxic synthetic polyethylene fiber. Light source protected by UV resistant polyethylene globe.

Consulte la tabla de reguladores TRIAC recomendados en la página 212.

Please check the list of recommended TRIAC dimmers at page 212.

Caja soporte: ø 12 cm  
Surface back box: ø 4.72"

Personalizable: consultar  
Customizable: consult

Certificaciones  
Certifications



## Descripción lámpara / Lamps description:

230V 50Hz | IP-66 | TRIAC | 9 W LED / CRI: 90 / 2700°K | 960 lm fuente de luz / light source

Ref	Acabados / Finishing	Ean13	Euros
3350701201/P803	LED dimable TRIAC - Blanco Roto Pantalla Blanco Marfil* LED TRIAC Dimmable - Natural White Ivory White Shade*	8435493709772	451,00
3350701201/P804	LED dimable TRIAC - Blanco Roto Pantalla Marrón* LED TRIAC Dimmable - Natural White Brown Shade*	8435493709789	451,00
3350701203/P803	LED dimable TRIAC - Marrón Grafito Pantalla Blanco Marfil* LED TRIAC Dimmable - Graphite Brown Ivory White Shade*	8435493709796	451,00
3350701203/P804	LED dimable TRIAC - Marrón Grafito Pantalla Marrón* LED TRIAC Dimmable - Graphite Brown Brown Shade*	8435493709802	451,00

\*Por favor, tenga en cuenta que los tonos de color de la pantalla pueden no ser los mismos en todos los casos. / Please note that the shades may have small variations in tone.

Nota de uso: Para ambientes con alto grado de salinidad, será necesario realizar un correcto mantenimiento de la luminaria. Recomendamos limpiar con un cepillo suave y retirar la sal, el polvo, o la suciedad depositada por la humedad o el viento.

Note of use: For environments with a high salinity, proper maintenance of the luminaire will be necessary. We recommend cleaning it with a soft brush and remove salt, dust, or dirt deposited by moisture or wind.

## Familia / Family: Garota

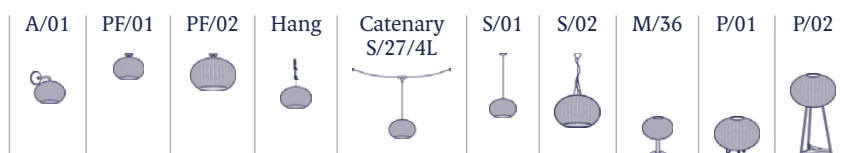

# Garota PF/01 Outdoor

Diseño / Design:

Alex Fernández Camps | Gonzalo Milà / 2015

Tipología: Plafón

Typology: Ceiling lamp

Ambiente: Exterior

Environment: Outdoor

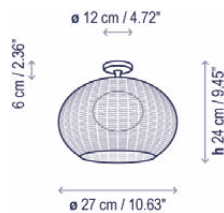

## Descripción técnica / Technical description:

Peso Neto: 1,32 kg  
Net Weight: 1,32 kg

1 Caja/Box | 28 x 28 x 41 cm | 0,0321 m<sup>3</sup>  
Peso bruto / Gross Weight: 1,9 kg

Materiales: Aluminio, Acero Inoxidable, Polietileno, Fibra Sintética.

Materials: Aluminum, Stainless steel, Polyethylene, Synthetic fiber.

Estructuras de metal acabadas con cataforesis y pintura de poliéster epoxi.

Metal surfaces coated with cataphoresis and epoxy polyester paint.

Pantallas tejidas a mano con fibra de polietileno sintética reciclable y no tóxica. Fuente de luz protegida por globo de polietileno y protección UV.

Hand woven with a recyclable and non-toxic synthetic polyethylene fiber. Light source protected by UV resistant polyethylene globe.

Consulte la tabla de reguladores TRIAC recomendados en la página 212.

Please check the list of recommended TRIAC dimmers at page 212.

Personalizable: consultar

Customizable: consult

Certificaciones  
Certifications



## Descripción lámpara / Lamps description:

230V 50Hz | IP-66 | TRIAC | 9 W LED / CRI: 90 / 2700°K | 960 lm fuente de luz / light source

Ref	Acabados / Finishing	Ean13	Euros
3350110401/P803	LED dimable TRIAC - Blanco Roto Pantalla Blanco Marfil* LED TRIAC Dimmable - Natural White Ivory White Shade*	8435493709390	430,00
3350110401/P804	LED dimable TRIAC - Blanco Roto Pantalla Marrón* LED TRIAC Dimmable - Natural White Brown Shade*	8435493709406	430,00
3350110403/P803	LED dimable TRIAC - Marrón Grafito Pantalla Blanco Marfil* LED TRIAC Dimmable - Graphite Brown Ivory White Shade*	8435493709413	430,00
3350110403/P804	LED dimable TRIAC - Marrón Grafito Pantalla Marrón* LED TRIAC Dimmable - Graphite Brown Brown Shade*	8435493709420	430,00

\*Por favor, tenga en cuenta que los tonos de color de la pantalla pueden no ser los mismos en todos los casos. / Please note that the shades may have small variations in tone.

Nota de uso: Para ambientes con alto grado de salinidad, será necesario realizar un correcto mantenimiento de la luminaria. Recomendamos limpiar con un cepillo suave y retirar la sal, el polvo, o la suciedad depositada por la humedad o el viento.

Note of use: For environments with a high salinity, proper maintenance of the luminaire will be necessary. We recommend cleaning it with a soft brush and remove salt, dust, or dirt deposited by moisture or wind.

Familia / Family: Garota

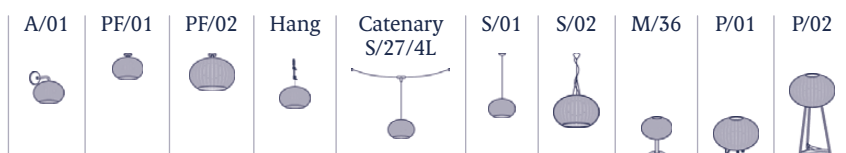

# Garota PF/02 Outdoor

Diseño / Design:

Alex Fernández Camps | Gonzalo Milà / 2015

Tipología: Plafón

Typology: Ceiling lamp

Ambiente: Exterior

Environment: Outdoor

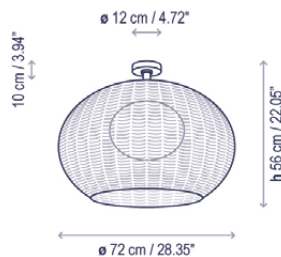

## Descripción técnica / Technical description:

Peso Neto: 5,68 kg  
Net Weight: 5,68 kg

1 Caja/Box | 82 x 82 x 48 cm | 0,3228 m<sup>3</sup>  
Peso bruto / Gross Weight: 9,36 kg

Materiales: Aluminio, Acero Inoxidable, Polietileno, Fibra Sintética.

Materials: Aluminum, Stainless steel, Polyethylene, Synthetic fiber.

Estructuras de metal acabadas con cataforesis y pintura de poliéster epoxi.

Metal surfaces coated with cataphoresis and epoxy polyester paint.

Pantallas tejidas a mano con fibra de polietileno sintética reciclable y no tóxica. Fuente de luz protegida por globo de polietileno y protección UV.

Hand woven with a recyclable and non-toxic synthetic polyethylene fiber. Light source protected by UV resistant polyethylene globe.

Personalizable: consultar

Customizable: consult

Bombillas no incluidas

Bulbs not included

Certificaciones  
Certifications



## Descripción lámpara / Lamps description:

230V 50Hz | IP-66 | 2 x 22 W CFL E-27 | 2 x 9 W LED E-27 A60

Ref	Acabados / Finishing	Ean13	Euros
3350210001/P801	Blanco Roto - Pantalla Blanco Marfil* Natural White - Ivory White Shade*	8435493709574	730,00
3350210001/P802	Blanco Roto - Pantalla Marrón* Natural White - Brown Shade*	8435493709581	730,00
3350210003/P801	Marrón Grafito - Pantalla Blanco Marfil* Graphite Brown - Ivory White Shade*	8435493709598	730,00
3350210003/P802	Marrón Grafito - Pantalla Marrón* Graphite Brown - Brown Shade*	8435493709604	730,00

\*Por favor, tenga en cuenta que los tonos de color de la pantalla pueden no ser los mismos en todos los casos. / Please note that the shades may have small variations in tone.

Nota de uso: Para ambientes con alto grado de salinidad, será necesario realizar un correcto mantenimiento de la luminaria. Recomendamos limpiar con un cepillo suave y retirar la sal, el polvo, o la suciedad depositada por la humedad o el viento.

Note of use: For environments with a high salinity, proper maintenance of the luminaire will be necessary. We recommend cleaning it with a soft brush and remove salt, dust, or dirt deposited by moisture or wind.

## Familia / Family: Garota

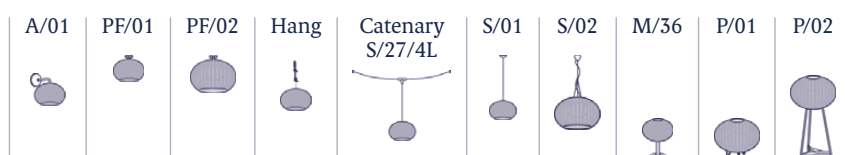



# Garota Hang

Diseño / Design:

Alex Fernández Camps | Gonzalo Milà / 2015

Tipología: Suspensión

Typology: Pendant lamp

Ambiente: Exterior

Environment: Outdoor

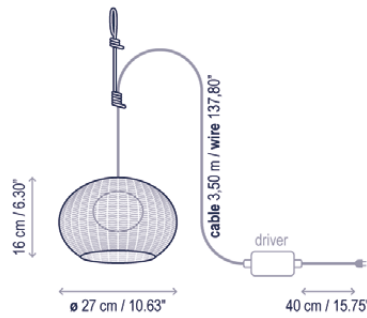

## Descripción técnica / Technical description:

Peso Neto: 1,55 kg  
Net Weight: 1,55 kg

1 Caja/Box | 29 x 29 x 22 cm | 0,0185 m<sup>3</sup>  
Peso bruto / Gross Weight: 2,02 kg

Materiales: Aluminio, Acero Inoxidable, Polietileno, Fibra Sintética.

Materials: Aluminum, Stainless steel, Polyethylene, Synthetic fiber.

Estructuras de metal acabadas con cataforesis y pintura de poliéster epoxi.

Metal surfaces coated with cathaphoresis and epoxy polyester paint.

Pantallas tejidas a mano con fibra de polietileno sintética reciclable y no tóxica. Fuente de luz protegida por globo de polietileno y protección UV.

Hand woven with a recyclable and non-toxic synthetic polyethylene fiber. Light source protected by UV resistant polyethylene globe.

Cable sin interruptor de neopreno negro resistente al agua. Transformador instalado en el cable. Incluye accesorio de goma que facilita la instalación temporal de la luminaria en diferentes espacios.

Black waterproof neoprene cable without switch. Driver installed on the cable. Includes a hooked rubber accessory that facilitates the temporary installation to many different placements.

Personalizable: consultar

Customizable: consult

Certificaciones  
Certifications



Recambios / Spare parts:

R906015 Cable Neopreno / Neoprene Cable

## Descripción lámpara / Lamps description:

230V 50Hz | IP-66 | 9 W LED / CRI: 90 / 2700°K | 960 lm fuente de luz / light source

Ref	Acabados / Finishing	Ean13	Euros
3350720101/P803	Blanco Roto - Pantalla Blanco Marfil* Natural White - Ivory White Shade*	8435493709819	439,00
3350720101/P804	Blanco Roto - Pantalla Marrón* Natural White - Brown Shade*	8435493709826	439,00
3350720103/P803	Marrón Grafito - Pantalla Blanco Marfil* Graphite Brown - Ivory White Shade*	8435493709833	439,00
3350720103/P804	Marrón Grafito - Pantalla Marrón* Graphite Brown - Brown Shade*	8435493709840	439,00

\*Por favor, tenga en cuenta que los tonos de color de la pantalla pueden no ser los mismos en todos los casos. / Please note that the shades may have small variations in tone.

Nota de uso: Para ambientes con alto grado de salinidad, será necesario realizar un correcto mantenimiento de la luminaria. Recomendamos limpiar con un cepillo suave y retirar la sal, el polvo, o la suciedad depositada por la humedad o el viento.

Note of use: For environments with a high salinity, proper maintenance of the luminaire will be necessary. We recommend cleaning it with a soft brush and remove salt, dust, or dirt deposited by moisture or wind.

Familia / Family: Garota

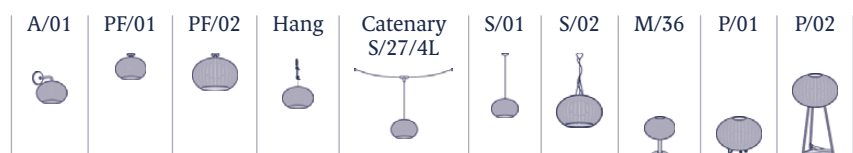



# Garota Catenary S/27/4L Outdoor

Diseño / Design:

Alex Fernández Camps | Gonzalo Milà / 2015

Tipología: Suspensión

Typology: Pendant lamp

Ambiente: Exterior

Environment: Outdoor

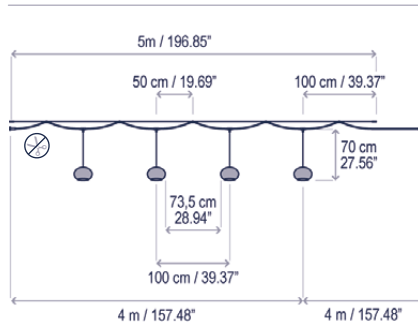

⊗ Este extremo NO puede ser cortado durante la instalación.  
Edge NOT cuttable on field.



Descripción técnica / Technical description:

Peso Neto: 4,2 kg  
Net Weight: 4,2 kg

1 Caja/Box | 67 x 67 x 25 cm | 0,1122 m<sup>3</sup>  
Peso bruto / Gross Weight: 5,7 kg

Materiales: Aluminio, Acero Inoxidable, Polietileno, Fibra Sintética.

Materials: Aluminum, Stainless steel, Polyethylene, Synthetic fiber.

Estructuras de metal acabadas con cataforesis y pintura de poliéster epoxi.

Metal surfaces coated with cataphoresis and epoxy polyester paint.

Pantallas tejidas a mano con fibra de polietileno sintética reciclable y no tóxica. Fuente de luz protegida por globo de polietileno y protección UV.

Hand woven with a recyclable and non-toxic synthetic polyethylene fiber. Light source protected by UV resistant polyethylene globe.

Cable de neopreno negro resistente al agua  
Black waterproof neoprene cable

Fijación tensor  
Tensor anchoring

Fijación cable eléctrico  
Electrical wire anchoring

Enchufe clavija tipo C  
Plug type C

Florón (opcional)  
Canopy (optional)  
Ø 7 cm / 2.76"  
h 7 cm / 2.76"

Accesorios / Accessories:

AC335001 Florón / Canopy

Personalizable: consultar / Customizable: consult

Certificaciones  
Certifications



Descripción lámpara / Lamps description:

230V 50Hz | IP-66 | 24 W LED / CRI: 90 / 2700°K  
1652 lm fuente de luz / light source

Ref	Acabados / Finishing	Ean13	Euros
3350320101/P803	Negro Neopreno - Pantalla Blanco Marfil* Black Neoprene - Ivory White Shade*	8435493725352	953,00
3350320103/P804	Negro Neopreno - Pantalla Marrón* Black Neoprene - Brown Shade*	8435493725383	953,00

\*Por favor, tenga en cuenta que los tonos de color de la pantalla pueden no ser los mismos en todos los casos. / Please note that the shades may have small variations in tone.

Nota de uso: Para ambientes con alto grado de salinidad, será necesario realizar un correcto mantenimiento de la luminaria. Recomendamos limpiar con un cepillo suave y retirar la sal, el polvo, o la suciedad depositada por la humedad o el viento.

Note of use: For environments with a high salinity, proper maintenance of the luminaire will be necessary. We recommend cleaning it with a soft brush and remove salt, dust, or dirt deposited by moisture or wind.

Familia / Family: Garota

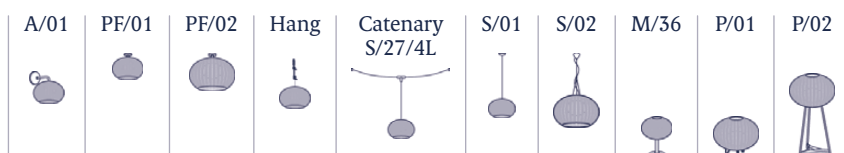

# Garota S/01 Outdoor

Diseño / Design:

Alex Fernández Camps | Gonzalo Milà / 2015

Tipología: Suspensión

Typology: Pendant lamp

Ambiente: Exterior

Environment: Outdoor

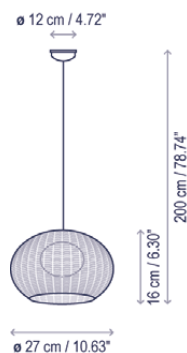

## Descripción técnica / Technical description:

Peso Neto: 1,41 kg  
Net Weight: 1,41 kg

1 Caja/Box | 29 x 29 x 22 cm | 0,0185 m<sup>3</sup>  
Peso bruto / Gross Weight: 1,77 kg

Materiales: Aluminio, Acero Inoxidable, Polietileno, Fibra Sintética.

Materials: Aluminum, Stainless steel, Polyethylene, Synthetic fiber.

Estructuras de metal acabadas con cataforesis y pintura de poliéster epoxi.

Metal surfaces coated with cathaphoresis and epoxy polyester paint.

Pantallas tejidas a mano con fibra de polietileno sintética reciclable y no tóxica. Fuente de luz protegida por globo de polietileno y protección UV.

Hand woven with a recyclable and non-toxic synthetic polyethylene fiber. Light source protected by UV resistant polyethylene globe.

Cable de neopreno negro resistente al agua  
Black waterproof neoprene cable

Consulte la tabla de reguladores TRIAC recomendados en la página 212.

Please check the list of recommended TRIAC dimmers at page 212.

Personalizable: consultar

Customizable: consult

Certificaciones

Certifications



Recambios / Spare parts:

R906015 Cable Neopreno / Neoprene Cable

## Descripción lámpara / Lamps description:

230V 50Hz IP-66 TRIAC 9 W LED / CRI: 90 / 2700°K 960 lm fuente de luz / light source

Ref	Acabados / Finishing	Ean13	Euros
3350121401/P803	LED dimable TRIAC - Blanco Roto Pantalla Blanco Marfil* LED TRIAC Dimmable - Natural White Ivory White Shade*	8435493709512	427,00
3350121401/P804	LED dimable TRIAC - Blanco Roto Pantalla Marrón* LED TRIAC Dimmable - Natural White Brown Shade*	8435493709529	427,00
3350121403/P803	LED dimable TRIAC - Marrón Grafito Pantalla Blanco Marfil* LED TRIAC Dimmable - Graphite Brown Ivory White Shade*	8435493709536	427,00
3350121403/P804	LED dimable TRIAC - Marrón Grafito Pantalla Marrón* LED TRIAC Dimmable - Graphite Brown Brown Shade*	8435493709543	427,00

\*Por favor, tenga en cuenta que los tonos de color de la pantalla pueden no ser los mismos en todos los casos. / Please note that the shades may have small variations in tone.

Nota de uso: Para ambientes con alto grado de salinidad, será necesario realizar un correcto mantenimiento de la luminaria. Recomendamos limpiar con un cepillo suave y retirar la sal, el polvo, o la suciedad depositada por la humedad o el viento.

Note of use: For environments with a high salinity, proper maintenance of the luminaire will be necessary. We recommend cleaning it with a soft brush and remove salt, dust, or dirt deposited by moisture or wind.

Familia / Family: Garota

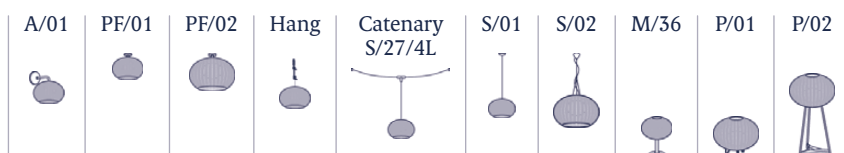

# Garota S/02 Outdoor

Diseño / Design:

Alex Fernández Camps | Gonzalo Milà / 2015

Tipología: Suspensión

Typology: Pendant lamp

Ambiente: Exterior

Environment: Outdoor

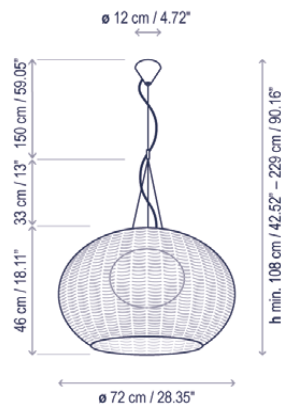

## Descripción técnica / Technical description:

Peso Neto: 5,46 kg  
Net Weight: 5,46 kg

1 Caja/Box | 78 x 78 x 45 cm | 0,2738 m<sup>3</sup>  
Peso bruto / Gross Weight: 9,14 kg

Materiales: Aluminio, Acero Inoxidable, Polietileno, Fibra Sintética.

Materials: Aluminum, Stainless steel, Polyethylene, Synthetic fiber.

Estructuras de metal acabadas con cataforesis y pintura de poliéster epoxi.

Metal surfaces coated with cataphoresis and epoxy polyester paint.

Pantallas tejidas a mano con fibra de polietileno sintética reciclable y no tóxica. Fuente de luz protegida por globo de polietileno y protección UV.

Hand woven with a recyclable and non-toxic synthetic polyethylene fiber. Light source protected by UV resistant polyethylene globe.

Cable de neopreno negro resistente al agua. Cables tensores de acero inoxidable. Black waterproof neoprene cable. Stainless steel tensor cables.

Personalizable: consultar  
Customizable: consult

Bombillas no incluidas  
Bulbs not included

Certificaciones  
Certifications



## Descripción lámpara / Lamps description:

230V 50Hz | IP-66 | 2 x 22 W CFL E-27 | 2 x 9 W LED E-27 A60

Ref	Acabados / Finishing	Ean13	Euros
3350220201/P801	Blanco Roto - Pantalla Blanco Marfil* Natural White - Ivory White Shade*	8435493709611	725,00
3350220201/P802	Blanco Roto - Pantalla Marrón* Natural White - Brown Shade*	8435493709628	725,00
3350220203/P801	Marrón Grafito - Pantalla Blanco Marfil* Graphite Brown - Ivory White Shade*	8435493709635	725,00
3350220203/P802	Marrón Grafito - Pantalla Marrón* Graphite Brown - Brown Shade*	8435493709642	725,00

\*Por favor, tenga en cuenta que los tonos de color de la pantalla pueden no ser los mismos en todos los casos. / Please note that the shades may have small variations in tone.

Nota de uso: Para ambientes con alto grado de salinidad, será necesario realizar un correcto mantenimiento de la luminaria. Recomendamos limpiar con un cepillo suave y retirar la sal, el polvo, o la suciedad depositada por la humedad o el viento.

Note of use: For environments with a high salinity, proper maintenance of the luminaire will be necessary. We recommend cleaning it with a soft brush and remove salt, dust, or dirt deposited by moisture or wind.

## Familia / Family: Garota

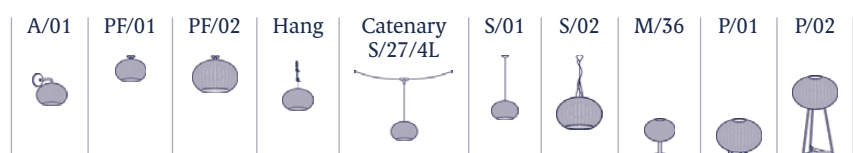

# Garota M/36 Outdoor

Diseño / Design:

Alex Fernández Camps | Gonzalo Milà / 2015

Tipología: Mesa

Typology: Table lamp

Ambiente: Exterior

Environment: Outdoor

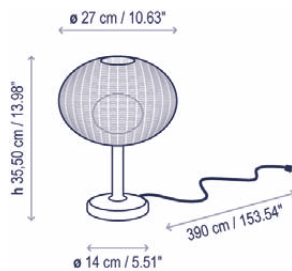

## Descripción técnica / Technical description:

Peso Neto: 1,94 kg  
Net Weight: 1,94 kg

1 Caja/Box | 28 x 28 x 41 cm | 0,0321 m<sup>3</sup>  
Peso bruto / Gross Weight: 2,52 kg

Materiales: Aluminio, Acero Inoxidable, Polietileno, Fibra Sintética.

Materials: Aluminum, Stainless steel, Polyethylene, Synthetic fiber.

Estructuras de metal acabadas con cataforesis y pintura de poliéster epoxi.

Metal surfaces coated with cataphoresis and epoxy polyester paint.

Pantallas tejidas a mano con fibra de polietileno sintética reciclable y no tóxica. Fuente de luz protegida por globo de polietileno y protección UV.

Hand woven with a recyclable and non-toxic synthetic polyethylene fiber. Light source protected by UV resistant polyethylene globe.

Cable de neopreno negro resistente al agua sin interruptor.

Black waterproof neoprene cable without switch.

Personalizable: consultar

Customizable: consult

Certificaciones  
Certifications



## Descripción lámpara / Lamps description:

230V 50Hz | IP-66 | 9 W LED / CRI: 90 / 2700°K | 960 lm fuente de luz / light source

Ref	Acabados / Finishing	Ean13	Euros
3350630101/P803	Blanco Roto - Pantalla Blanco Marfil* Natural White - Ivory White Shade*	8435493722467	476,00
3350630103/P804	Marrón Grafito - Pantalla Marrón* Graphite Brown - Brown Shade*	8435493722481	476,00

\*Por favor, tenga en cuenta que los tonos de color de la pantalla pueden no ser los mismos en todos los casos. / Please note that the shades may have small variations in tone.

Nota de uso: Para ambientes con alto grado de salinidad, será necesario realizar un correcto mantenimiento de la luminaria. Recomendamos limpiar con un cepillo suave y retirar la sal, el polvo, o la suciedad depositada por la humedad o el viento.

Note of use: For environments with a high salinity, proper maintenance of the luminaire will be necessary. We recommend cleaning it with a soft brush and remove salt, dust, or dirt deposited by moisture or wind.

## Familia / Family: Garota

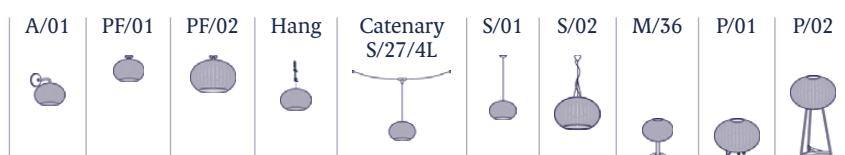

# Garota P/01 Outdoor

Diseño / Design:

Alex Fernández Camps | Gonzalo Milà / 2015

Tipología: Pie

Typology: Floor lamp

Ambiente: Exterior

Environment: Outdoor

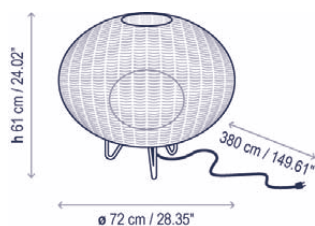

## Descripción técnica / Technical description:

**Peso Neto: 6,41 kg**  
Net Weight: 6,41 kg

**1 Caja/Box | 88 x 88 x 72 cm | 0,5576 m<sup>3</sup>**  
Peso bruto / Gross Weight: 14,28 kg

**Materiales: Aluminio, Acero Inoxidable, Polietileno, Fibra Sintética.**

*Materials: Aluminum, Stainless steel, Polyethylene, Synthetic fiber.*

**Estructuras de metal acabadas con cataforesis y pintura de poliéster epoxi.**

*Metal surfaces coated with cathaphoresis and epoxy polyester paint.*

**Pantallas tejidas a mano con fibra de polietileno sintética reciclable y no tóxica. Fuente de luz protegida por globo de polietileno y protección UV.**

*Hand woven with a recyclable and non-toxic synthetic polyethylene fiber. Light source protected by UV resistant polyethylene globe.*

**Cable sin interruptor de neopreno negro resistente al agua. Consulte opciones de anclaje al suelo. Instalación eléctrica sin enchufe disponible bajo pedido.**

*Black waterproof neoprene cable without switch. Consult for fastening options. Hardwired version upon request.*

**Personalizable: consultar**

*Customizable: consult*

**Bombillas no incluidas**

*Bulbs not included*

**Certificaciones**  
Certifications



**Recambios / Spare parts:**

**R3356988 Fijación a suelo acero inoxidable**  
*Stainless steel floor fastening*

## Descripción lámpara / Lamps description:

**230V 50Hz** | **IP-66** | **2 x 22 W CFL E-27** | **2 x 9 W LED E-27 A60**

Ref	Acabados / Finishing	Ean13	Euros
3350130088/P801	Acero Inoxidable - Pantalla Blanco Marfil* <i>Stainless Steel - Ivory White Shade*</i>	8435493709550	729,00
3350130088/P802	Acero Inoxidable - Pantalla Marrón* <i>Stainless Steel - Brown Shade*</i>	8435493709567	729,00

**\*Por favor, tenga en cuenta que los tonos de color de la pantalla pueden no ser los mismos en todos los casos. / Please note that the shades may have small variations in tone.**

**Nota de uso: Para ambientes con alto grado de salinidad, será necesario realizar un correcto mantenimiento de la luminaria. Recomendamos limpiar con un cepillo suave y retirar la sal, el polvo, o la suciedad depositada por la humedad o el viento.**

*Note of use: For environments with a high salinity, proper maintenance of the luminaire will be necessary. We recommend cleaning it with a soft brush and remove salt, dust, or dirt deposited by moisture or wind.*

Familia / Family: Garota

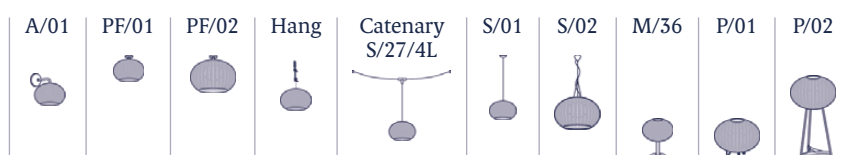



# Garota P/02 Outdoor

Diseño / Design:

Alex Fernández Camps | Gonzalo Milà / 2015

Tipología: Pie

Typology: Floor lamp

Ambiente: Exterior

Environment: Outdoor

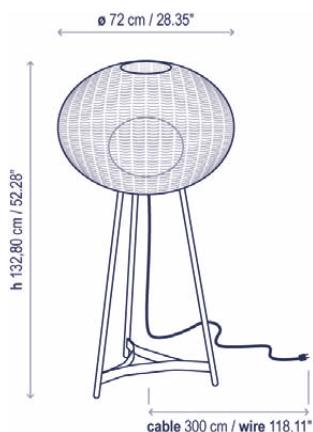

## Descripción técnica / Technical description:

Peso Neto: 9,51 kg  
Net Weight: 9,51 kg

1 Caja/Box | 88 x 88 x 141 cm | 1,0919 m<sup>3</sup>  
Peso bruto / Gross Weight: 17,7 kg

Materiales: Aluminio, Acero Inoxidable, Polietileno, Fibra Sintética.

Materials: Aluminum, Stainless steel, Polyethylene, Synthetic fiber.

Estructuras de metal acabadas con cataforesis y pintura de poliéster epoxi.

Metal surfaces coated with cathaphoresis and epoxy polyester paint.

Pantallas tejidas a mano con fibra de polietileno sintética reciclable y no tóxica. Fuente de luz protegida por globo de polietileno y protección UV.

Hand woven with a recyclable and non-toxic synthetic polyethylene fiber. Light source protected by UV resistant polyethylene globe.

Cable sin interruptor de neopreno negro resistente al agua. Consulte opciones de anclaje al suelo. Instalación eléctrica sin enchufe disponible bajo pedido.

Black waterproof neoprene cable without switch. Consult for fastening options. Hardwired version upon request.

Personalizable: consultar  
Customizable: consult

Bombillas no incluidas  
Bulbs not included

Certificaciones  
Certifications

Recambios / Spare parts:

R3356813 Fijación a suelo blanco roto  
Natural white floor fastening

R3356814 Fijación a suelo marrón grafito  
Graphite brown floor fastening

## Descripción lámpara / Lamps description:

IP-66 2 x 22 W CFL E-27 2 x 9 W LED E-27 A60

Ref	Acabados / Finishing	Ean13	Euros
3350230001/P801	Blanco Roto - Pantalla Blanco Marfil* Natural White - Ivory White Shade*	8435493709659	1.020,00
3350230001/P802	Blanco Roto - Pantalla Marrón* Natural White - Brown Shade*	8435493709666	1.020,00
3350230003/P801	Marrón Grafito - Pantalla Blanco Marfil* Graphite Brown - Ivory White Shade*	8435493709673	1.020,00
3350230003/P802	Marrón Grafito - Pantalla Marrón* Graphite Brown - Brown Shade*	8435493709680	1.020,00

\*Por favor, tenga en cuenta que los tonos de color de la pantalla pueden no ser los mismos en todos los casos. / Please note that the shades may have small variations in tone.

Nota de uso: Para ambientes con alto grado de salinidad, será necesario realizar un correcto mantenimiento de la luminaria. Recomendamos limpiar con un cepillo suave y retirar la sal, el polvo, o la suciedad depositada por la humedad o el viento.

Note of use: For environments with a high salinity, proper maintenance of the luminaire will be necessary. We recommend cleaning it with a soft brush and remove salt, dust, or dirt deposited by moisture or wind.

## Familia / Family: Garota

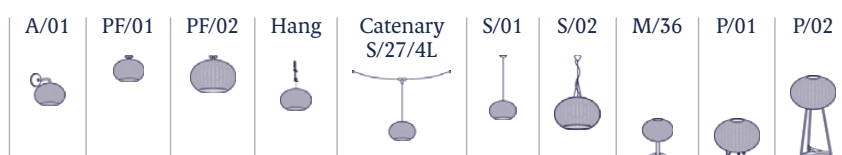



# Hardy

Diseño / Design:  
Sergi Devesa | Oscar Devesa / 2013

Tipología: Suspensión  
Typology: Pendant lamp

Ambiente: Interior  
Environment: Indoor

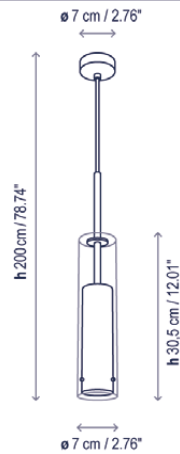

## Descripción técnica / Technical description:

Peso Neto: 0,98 kg  
Net Weight: 0,98 kg

1 Caja/Box | 14 x 47 x 24 cm | 0,0158 m<sup>3</sup>  
Peso bruto / Gross Weight: 1,52 kg

Materiales: Cristal de borosilicato, Hierro, Latón.  
Materials: Borosilicate glass, Iron, Brass.

El acabado del florón coincide con el acabado de la lámpara.  
Canopy finishing matches the lamp finish

Cable eléctrico transparente  
Transparent electrical cable

Personalizable  
Customizable

Bombillas no incluidas  
Bulbs not included

Certificaciones  
Certifications

Recambios / Spare parts:

R312 Cristal Hardy / Hardy glass

## Descripción lámpara / Lamps description:

230V 50Hz | IP-20 1 x 6 W LED GU10

Ref	Acabados / Finishing	Ean13	Euros
4131221	Blanco White	8436544891156	239,00
4131206	Cromo Chrome	8436544891149	239,00
4131299	Dorado Golden	8436544891163	248,00

# Lexa

Diseño / Design:  
Joana Bover / 2008

Tipología: Aplique  
Typology: Wall lamp

Ambiente: Interior  
Environment: Indoor

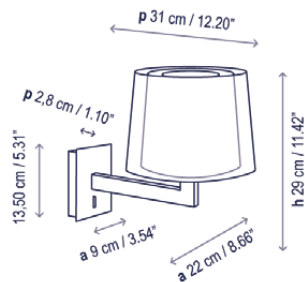

## Descripción técnica / Technical description:

Peso Neto: 0,98 kg  
Net Weight: 0,98 kg

1 Caja/Box | 47 x 47 x 37 cm | 0,0817 m<sup>3</sup>  
Peso bruto / Gross Weight: 3,14 kg

Materiales: Hierro, Latón  
Materials: Iron, Brass

Caja soporte: 7,8 x 12 cm  
Surface back box: 3.07" x 4.72"

Hilo incandescente pantalla / Shade GWF1

Cinta / Ribbon: 960°  
Cotonet Blanco / White Cotton: 800°

Personalizable  
Customizable

Bombillas no incluidas  
Bulbs not included

Certificaciones  
Certifications

## Descripción lámpara / Lamps description:

230V 50Hz | IP-20 | 1 x 46 W EcoClassic P45 E-27 | 1 x 11 W CFL E-27 | 1 x 6 W LED P45 E-27

Ref	Acabados / Finishing	Ean13	Euros
1120506/P634E	Cromo - Pantalla Cinta Translúcida Blanca Chrome - White Translucent Ribbon Shade	8435493722856	246,00
1120506/P635E	Cromo - Pantalla Cinta Translúcida Crema Chrome - Cream Translucent Ribbon Shade	8435493722863	246,00
1120506/P633E	Cromo - Pantalla Cotonet Blanco Chrome - White Cotton Shade	8435493722870	227,00
1120505/P634E	Níquel - Pantalla Cinta Translúcida Blanca Nickel - White Translucent Ribbon Shade	8435493702223	246,00
1120505/P635E	Níquel - Pantalla Cinta Translúcida Crema Nickel - Cream Translucent Ribbon Shade	8435493702230	246,00
1120505/P633E	Níquel - Pantalla Cotonet Blanco Nickel - White Cotton Shade	8435493702216	227,00

Familia / Family: Lexa

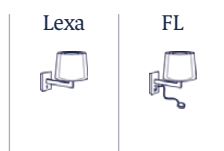

# Lexa FL

Diseño / Design:  
Joana Bover / 2008

Tipología: Aplique  
Typology: Wall lamp

Ambiente: Interior  
Environment: Indoor

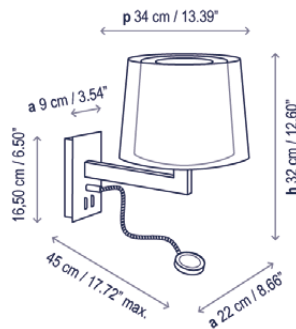

## Descripción técnica / Technical description:

**Peso Neto: 1,36 kg**  
Net Weight: 1,36 kg

**1 Caja/Box | 47 x 47 x 37 cm | 0,0817 m³**  
Peso bruto / Gross Weight: 3,49 kg

**Materiales: Hierro, Latón**  
Materials: Iron, Brass

**Caja soporte (vertical): 7,6 x 15 cm**  
Surface back box (vertical): 2.99" x 5.91"

**Caja soporte (horizontal): 17 x 7,6 cm**  
Surface back box (horizontal): 6.69" x 2.99"

**Hilo incandescente pantalla / Shade GWF1**

**Cinta / Ribbon: 960°**  
**Cotonet Blanco / White Cotton: 800°**

**Nota de uso: El flexo debe manipularse por la parte central del mismo. Manipular el flexo por los extremos puede ocasionar el deterioro de la malla.**

**Note of use: The flexo must be manipulated by the central part of it. Manipulating the flexo by the end can cause the mesh deterioration.**

**Personalizable**  
Customizable

**Bombillas no incluidas**  
Bulbs not included

**Certificaciones**  
Certifications

**Recambios / Spare parts:**

**RDRIVER Alimentador LED / LED Driver**

## Descripción lámpara (Aplique Vertical) / Lamps description (Vertical Backplate-Box):

**230V 50Hz** **IP-20** **1 x 46 W EcoClassic P45 E-27** **1 x 11 W CFL E-27** **1 x 6 W LED P45 E-27**

**1,2 W LED / CRI: 90 / 2700°K**  
85 lm fuente de luz / light source

Ref	Acabados / Finishing	Ean13	Euros
1220506/P634E	Cromo - Pantalla Cinta Translúcida Blanca Chrome - White Translucent Ribbon Shade	8435493703039	409,00
1220506/P635E	Cromo - Pantalla Cinta Translúcida Crema Chrome - Cream Translucent Ribbon Shade	8435493703046	409,00
1220506/P633E	Cromo - Pantalla Cotonet Blanco Chrome - White Cotton Shade	8435493703022	387,00
1220505/P634E	Níquel - Pantalla Cinta Translúcida Blanca Nickel - White Translucent Ribbon Shade	8435493702988	409,00
1220505/P635E	Níquel - Pantalla Cinta Translúcida Crema Nickel - Cream Translucent Ribbon Shade	8435493702995	409,00
1220505/P633E	Níquel - Pantalla Cotonet Blanco Nickel - White Cotton Shade	8435493702971	387,00

Familia / Family: Lexa

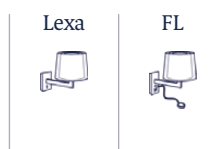

# Liban

Diseño / Design:

Lluís Porqueras | Cristian Diez / 2003

Tipología: Aplique

Typology: Wall lamp

Ambiente: Interior

Environment: Indoor

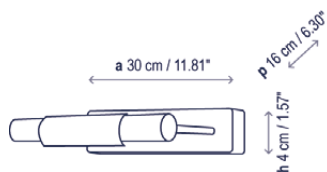

## Descripción técnica / Technical description:

 Peso Neto: 1,2 kg  
Net Weight: 1,2 kg

 1 Caja/Box | 35 x 22 x 9 cm | 0,0069 m<sup>3</sup>  
Peso bruto / Gross Weight: 1,46 kg

Materiales: Latón, Hierro  
Materials: Brass, Iron

Caja soporte: 27,8 x 4,1 cm  
Surface back box: 10.94" x 1.61"

Personalizable  
Customizable

Bombillas no incluidas  
Bulbs not included

Certificaciones  
Certifications



## Descripción lámpara / Lamps description:

  230V  
50Hz | IP-20 |  1 x 120 W R7s 118 mm HALO |  1 x 8 W R7s 118mm LED

Ref	Acabados / Finishing	Ean13	Euros
1118606	Cromo Brillante Brilliant Chrome	8436047301503	281,00
1118605	Níquel Satinado Satin Nickel	8436047301497	292,00

# Lineana H

Diseño / Design:  
Christophe Mathieu / 2010

Tipología: Aplique  
Typology: Wall lamp

Ambiente: Exterior  
Environment: Outdoor

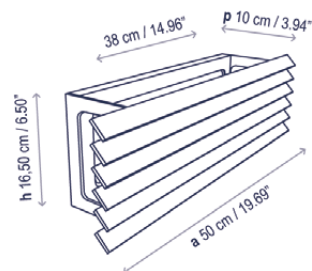

## Descripción técnica / Technical description:

Peso Neto: 2,8 kg  
Net Weight: 2,8 kg

1 Caja/Box | 70 x 24 x 16 cm | 0,0269 m<sup>3</sup>  
Peso bruto / Gross Weight: 3,38 kg

Materiales: Acero inoxidable, Aluminio  
Materials: Stainless steel, Aluminum

Difusor: Policarbonato  
Diffuser: Polycarbonate

Estructuras de metal acabadas con cataforesis y pintura de poliéster epoxi.  
Metal surfaces coated with cathaphoresis and epoxy polyester paint.

Caja soporte: 35,7 x 13,2 cm  
Surface back box: 14.06" x 5.2"

Personalizable: acabado  
Customizable: finishing

Bombillas no incluidas  
Bulbs not included

Certificaciones  
Certifications

## Descripción lámpara / Lamps description:

230V 50Hz | IP-66 | 2 x 9 W G9 | 2 x 3,5 W LED G9

Ref	Acabados / Finishing	Ean13	Euros
1121208H	Gris Grafito Grey Graphite	8436047307284	434,00
1121203H	Marrón Grafito Brown Graphite	8436047308946	434,00

## Descripción lámpara / Lamps description:

230V 50Hz | IP-66 | 26 W LED / CRI: 80 / 3000<sup>o</sup>K  
1880 lm fuente de luz / light source

Ref	Acabados / Finishing	Ean13	Euros
1121208LH	LED Gris Grafito LED Grey Graphite	8436544892528	608,00
1121203LH	LED Marrón Grafito LED Brown Graphite	8436544892535	608,00

Familia / Family: Lineana

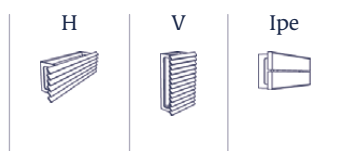

# Lineana V

Diseño / Design:  
Christophe Mathieu / 2010

Tipología: Aplique  
Typology: Wall lamp

Ambiente: Exterior  
Environment: Outdoor

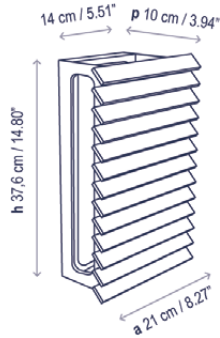

## Descripción técnica / Technical description:

Peso Neto: 2,76 kg  
Net Weight: 2,76 kg

1 Caja/Box | 70 x 24 x 16 cm | 0,0269 m<sup>3</sup>  
Peso bruto / Gross Weight: 3,34 kg

Materiales: Acero inoxidable, Aluminio  
Materials: Stainless steel, Aluminum

Difusor: Policarbonato  
Diffuser: Polycarbonate

Estructuras de metal acabadas con cataforesis y pintura de poliéster epoxi.  
Metal surfaces coated with cataphoresis and epoxy polyester paint.

Caja soporte: 13,2 x 35,7 cm  
Surface back box: 5.2" x 14.06"

Personalizable: acabado  
Customizable: finishing

Bombillas no incluidas  
Bulbs not included

Certificaciones  
Certifications

## Descripción lámpara / Lamps description:

230V 50Hz | IP-66 | 2 x 9 W G9 | 2 x 3,5 W LED G9

Ref	Acabados / Finishing	Ean13	Euros
1121208V	Gris Grafito Grey Graphite	8436047307499	466,00
1121203V	Marrón Grafito Brown Graphite	8436047307505	466,00

## Descripción lámpara / Lamps description:

230V 50Hz | IP-66 | 26 W LED / CRI: 80 / 3000<sup>o</sup>K  
1880 lm fuente de luz / light source

Ref	Acabados / Finishing	Ean13	Euros
1121208LV	LED Gris Grafito LED Grey Graphite	8436544892573	645,00
1121203LV	LED Marrón Grafito LED Brown Graphite	8436544892597	645,00

Familia / Family: Lineana

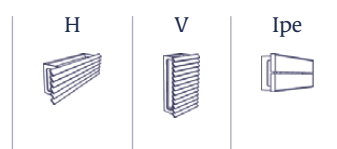



# Lineana Ipé

Diseño / Design:  
Christophe Mathieu / 2010

Tipología: Aplique  
Typology: Wall lamp

Ambiente: Exterior  
Environment: Outdoor

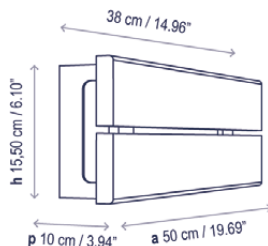

## Descripción técnica / Technical description:

Peso Neto: 3,22 kg  
Net Weight: 3,22 kg

1 Caja/Box | 70 x 24 x 16 cm | 0,0269 m<sup>3</sup>  
Peso bruto / Gross Weight: 4,31 kg

Materiales: Acero inoxidable, Aluminio, Madera Ipé.  
Materials: Stainless steel, Aluminum, Ipe wood

Difusor: Policarbonato  
Diffuser: Polycarbonate

Estructuras de metal acabadas con cataforesis y pintura de poliéster epoxi.  
Metal surfaces coated with cathaphoresis and epoxy polyester paint.

Caja soporte: 35,7 x 13,2 cm  
Surface back box: 14.06" x 5.2"

Personalizable: acabado  
Customizable: finishing

Bombillas no incluidas  
Bulbs not included

Certificaciones  
Certifications



## Descripción lámpara / Lamps description:

230V 50Hz | IP-66 | 2 x 9 W G9 | 2 x 3,5 W LED G9

Ref	Acabados / Finishing	Ean13	Euros
IPE21208H	Gris Grafito - Madera Ipé Grey Graphite - Ipe Wood	8436047309578	421,00
IPE21203H	Marrón Grafito - Madera Ipé Brown Graphite - Ipe Wood	8436544890593	421,00

## Descripción lámpara / Lamps description:

230V 50Hz | IP-66 | 26 W LED / CRI: 80 / 5000<sup>o</sup>K  
1880 lm fuente de luz / light source

Ref	Acabados / Finishing	Ean13	Euros
IPE21208LH	LED Gris Grafito - Madera Ipé LED Grey Graphite - Ipe Wood	8436544892627	595,00
IPE21203LH	LED Marrón Grafito - Madera Ipé LED Brown Graphite - Ipe Wood	8436544892641	595,00

Familia / Family: Lineana

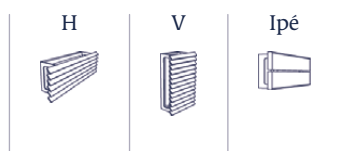

# Mar

Diseño / Design:  
Joana Bover / 2004

Tipología: Suspensión  
Typology: Pendant lamp

Ambiente: Interior  
Environment: Indoor

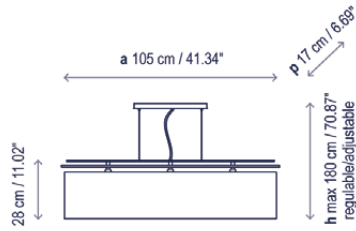

## Descripción técnica / Technical description:

Peso Neto: 4,57 kg  
Net Weight: 4,57 kg

1 Caja/Box | 35 x 47 x 161 cm | 0,2648 m<sup>3</sup>  
Peso bruto / Gross Weight: 8,52 kg

Materiales: Hierro, Piel  
Materials: Iron, Leather

Difusor inferior: PVC 500  
Lower diffuser: PVC 500

Cable eléctrico transparente. Cables tensores de acero inoxidable.  
Transparent electrical cable. Stainless steel tensor cables.

Hilo incandescente pantalla / Shade GWF1

Cinta / Ribbon: 960°  
Cotonet / Cotton: 800°

Hilo incandescente difusor: 800°  
Diffuser GWF1: 800°

Personalizable  
Customizable

Bombillas no incluidas  
Bulbs not included

Certificaciones  
Certifications

Recambios / Spare parts:

RMARDIF Difusor / Diffuser  
R100 Sujeción Difusor / Diffuser Hooks

## Descripción lámpara / Lamps description:

230V 50Hz | IP-20 | 3 x 46 W EcoClassic P45 E-27 | 3 x 11 W CFL E-27 | 3 x 6 W LED P45 E-27

Ref	Acabados / Finishing	Ean13	Euros
4324405T/P522	Níquel - Pantalla Cinta Translúcida Blanca Nickel - White Translucent Ribbon Shade	8435493712208	678,00
4324405T/P521	Níquel - Pantalla Cinta Translúcida Crema Nickel - Cream Translucent Ribbon Shade	8435493712192	678,00
4324405T/P524	Níquel - Pantalla Cotonet Nickel - Cotton Shade	8435493712222	571,00
4324460/P522	Níquel Piel Oscura Pantalla Cinta Translúcida Blanca Nickel Dark Leather White Translucent Ribbon Shade	8435493712246	699,00
4324460/P521	Níquel Piel Oscura Pantalla Cinta Translúcida Crema Nickel Dark Leather Cream Translucent Ribbon Shade	8435493712239	699,00
4324460/P524	Níquel Piel Oscura Pantalla Cotonet Nickel Dark Leather - Cotton Shade	8435493712260	601,00

# Marietta S/32 Outdoor

Diseño / Design:  
Joana Bover / 2015

Tipología: Suspensión  
Typology: Pendant lamp

Ambiente: Exterior  
Environment: Outdoor

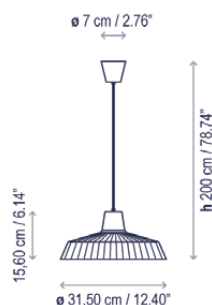

## Descripción técnica / Technical description:

Peso Neto: 1,04 kg  
Net Weight: 1,04 kg

1 Caja/Box | 40 x 40 x 25 cm | 0,04 m<sup>3</sup>  
Peso bruto / Gross Weight: 2,1 kg

Materiales: Polietileno de media densidad,  
Aluminio.  
Materials: Medium density polyethylene,  
Aluminum.

Estructuras de metal acabadas con cataforesis  
y pintura de poliéster epoxi.  
Metal surfaces coated with cataphoresis and  
epoxy polyester paint.

Fuente de luz protegida por pantalla de  
polietileno y protección UV.  
Light source protected by UV resistant  
polyethylene shade.

Cable de neopreno negro resistente al agua  
Black waterproof neoprene cable

No personalizable  
Not customizable

Certificaciones  
Certifications

## Descripción lámpara / Lamps description:

230V 50Hz | IP-66 | TRIAC | 8 W LED / CRI: 80 / 2700°K  
664 lm fuente de luz / light source

Ref	Acabados / Finishing	Ean13	Euros
3310121413	Regulable Triac - Blanco Dimmable Triac - White	8436544893518	339,00

# Maxi P/03

Diseño / Design:  
Joana Bover / 2004

Tipología: Pie  
Typology: Floor lamp

Ambiente: Interior  
Environment: Indoor

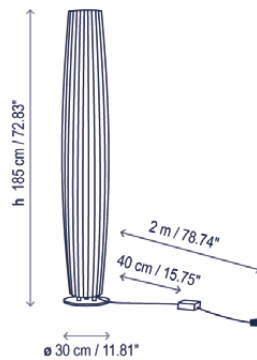

## Descripción técnica / Technical description:

Peso Neto: 7,42 kg  
Net Weight: 7,42 kg

1 Caja/Box | 35 x 33 x 201 cm | 0,2322 m<sup>3</sup>  
Peso bruto / Gross Weight: 11,38 kg

Materiales: Hierro, Latón  
Materials: Iron, Brass

Hilo incandescente pantalla: 960°  
Shade GWFI: 960°

Personalizable  
Customizable

Bombillas no incluidas  
Bulbs not included

Certificaciones  
Certifications

## Descripción lámpara / Lamps description:

230V 50Hz | IP-20 | 4 x 46 W EcoClassic P45 E-27 | 4 x 9 W LED A60 E-27

Ref	Acabados / Finishing	Ean13	Euros
1950330247	Níquel Satinado Halogena Dimable Pantalla Cinta Translúcida Blanca Satin Nickel Halo Dimmable White Translucent Ribbon Shade	8436535536561	860,00
1950330246	Níquel Satinado Halogena Dimable Pantalla Cinta Translúcida Crema Satin Nickel Halo Dimmable Cream Translucent Ribbon Shade	8436535539234	860,00

## Familia / Family: Maxi

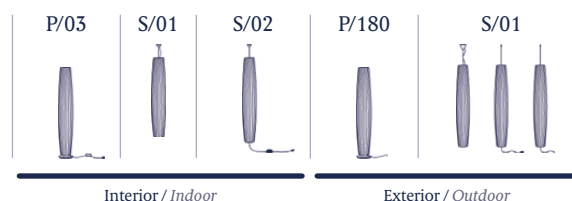

# Maxi S/01

Diseño / Design:  
Joana Bover / 2004

Tipología: Suspensión  
Typology: Pendant lamp

Ambiente: Interior  
Environment: Indoor

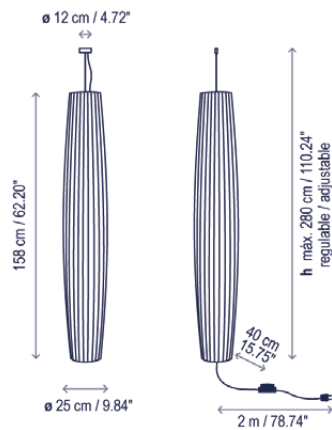

## Descripción técnica / Technical description:

Peso Neto: 2,76 kg  
Net Weight: 2,76 kg

1 Caja/Box | 29 x 29 x 172 cm | 0,1447 m<sup>3</sup>  
Peso bruto / Gross Weight: 4,94 kg

Materiales: Hierro, Latón  
Materials: Iron, Brass

Hilo incandescente pantalla: 960°  
Shade GWFI: 960°

Personalizable  
Customizable

Bombillas no incluidas  
Bulbs not included

Certificaciones  
Certifications

Recambios / Spare parts:

R411301 Tensor 1,5 m / Tensor 1,5 m  
R411303 Tensor 3 m / Tensor 3 m  
R411305 Tensor 5 m / Tensor 5 m  
RSUSP Suspensión / Suspension  
R907005 Cable 2x0,75 / Cable 2x0,75

## Descripción lámpara / Lamps description:

230V 50Hz | IP-20 | 4 x 46 W EcoClassic P45 E-27 | 4 x 30 W CFL E-27 | 4 x 9 W LED A60 E-27

Ref	Acabados / Finishing	Ean13	Euros
43195TOP/P508T	Instalación Superior - Níquel Satinado Pantalla Cinta Translúcida Blanca Upper Installation - Satin Nickel White Translucent Ribbon Shade	8435493722498	502,00
43195TOP/P507T	Instalación Superior - Níquel Satinado Pantalla Cinta Translúcida Crema Upper Installation - Satin Nickel Cream Translucent Ribbon Shade	8435493722511	502,00
4319505/P508I	Instalación Inferior - Níquel Satinado Pantalla Cinta Translúcida Blanca Bottom Installation - Satin Nickel White Translucent Ribbon Shade	8435493711584	502,00
4319505/P507I	Instalación Inferior - Níquel Satinado Pantalla Cinta Translúcida Crema Bottom Installation - Satin Nickel Cream Translucent Ribbon Shade	8435493711560	502,00

## Familia / Family: Maxi

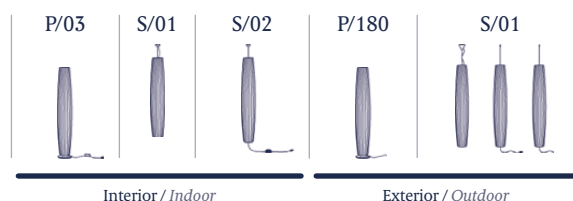

# Maxi S/02

Diseño / Design:  
Joana Bover / 2004

Tipología: Suspensión  
Typology: Pendant lamp

Ambiente: Interior  
Environment: Indoor

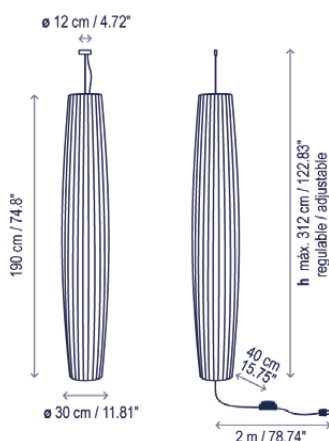

## Descripción técnica / Technical description:

Peso Neto: 3,94 kg  
Net Weight: 3,94 kg

1 Caja/Box | 35 x 33 x 201 cm | 0,2322 m<sup>3</sup>  
Peso bruto / Gross Weight: 7,95 kg

Materiales: Hierro, Latón  
Materials: Iron, Brass

Hilo incandescente pantalla: 960°  
Shade GWFI: 960°

Personalizable  
Customizable

Bombillas no incluidas  
Bulbs not included

Certificaciones  
Certifications

Recambios / Spare parts:

R411301 Tensor 1,5 m / Tensor 1,5 m  
R411303 Tensor 3 m / Tensor 3 m  
R411305 Tensor 5 m / Tensor 5 m  
RSUSP Suspensión / Suspension  
R907005 Cable 2x0,75 / Cable 2x0,75

## Descripción lámpara / Lamps description:

230V 50Hz | IP-20 | 4 x 46 W EcoClassic P45 E-27 | 4 x 30 W CFL E-27 | 4 x 9 W LED A60 E-27

Ref	Acabados / Finishing	Ean13	Euros
44195TOP/P509T	Instalación Superior - Níquel Satinado Pantalla Cinta Translúcida Blanca Upper Installation - Satin Nickel White Translucent Ribbon Shade	8435493712383	567,00
44195TOP/P506T	Instalación Superior - Níquel Satinado Pantalla Cinta Translúcida Crema Upper Installation - Satin Nickel Cream Translucent Ribbon Shade	8435493712369	567,00
4419505/P509I	Instalación Inferior - Níquel Satinado Pantalla Cinta Translúcida Blanca Bottom Installation - Satin Nickel White Translucent Ribbon Shade	8435493712338	567,00
4419505/P506I	Instalación Inferior - Níquel Satinado Pantalla Cinta Translúcida Crema Bottom Installation - Satin Nickel Cream Translucent Ribbon Shade	8435493712314	567,00

## Familia / Family: Maxi

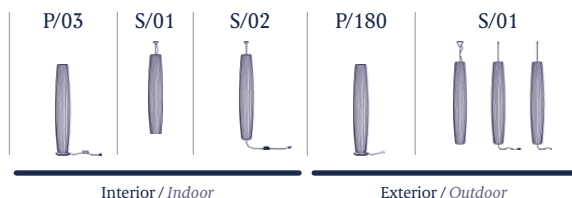



# Maxi P/180 Outdoor

Diseño / Design:  
Joana Bover / 2004

Tipología: Pie  
Typology: Floor lamp

Ambiente: Exterior  
Environment: Outdoor

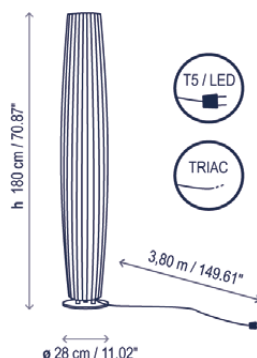

## Descripción técnica / Technical description:

Peso Neto: 13,8 kg  
Net Weight: 13,8 kg

1 Caja/Box | 35 x 33 x 201 cm | 0,2322 m<sup>3</sup>  
Peso bruto / Gross Weight: 18,1 kg

Materiales: Polietileno de media densidad,  
Hierro, Acero inoxidable.  
Medium density polyethylene, Iron, Stainless  
steel.

Fuente de luz protegida por pantalla de  
polietileno y protección UV.  
Light source protected by UV resistant  
polyethylene shade.

Cable sin interruptor de neopreno negro  
resistente al agua. Consulte opciones de  
anclaje al suelo. Instalación eléctrica fija  
disponible bajo pedido.  
Black waterproof neoprene cable without  
switch. Consult for fastening options.  
Hardwired version upon request.

\*Consulte la tabla de reguladores TRIAC  
recomendados en la página 212.  
\*Please check the list of recommended TRIAC  
dimmers at page 212.

No personalizable  
Not customizable

Bombillas no incluidas  
Bulbs not included

Certificaciones  
Certifications

## Descripción lámpara / Lamps description:

230V  
50Hz | IP-66 | 2 x 28W T5 HE

Ref	Acabados / Finishing	Ean13	Euros
3229500	Pantalla Polietileno Blanco White Polyethylene Shade	8436047309943	760,00

## Descripción lámpara / Lamps description:

230V  
50Hz | IP-66 | 49,2 W LED / CRI: 90 / 2700°K  
7500 lm fuente de luz / light source

Ref	Acabados / Finishing	Ean13	Euros
2950130300	LED - Pantalla Polietileno Blanco LED - White Polyethylene Shade	8436544893020	1.005,00

## Descripción lámpara / Lamps description:

230V  
50Hz | IP-66 | 49,2 W LED / CRI: 90 / 2700°K  
7500 lm fuente de luz / light source

Ref	Acabados / Finishing	Ean13	Euros
*2950130400	LED Regulable Triac - Pantalla Polietileno Blanco LED Dimmable Triac - White Polyethylene Shade	8436047301541	1.171,00

## Familia / Family: Maxi

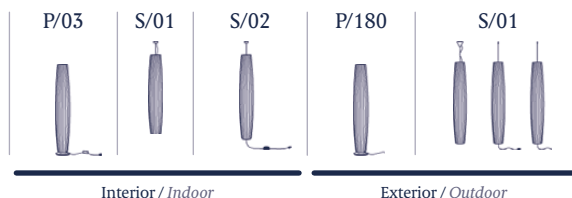

# Maxi S/01 Outdoor

Diseño / Design:  
Joana Bover / 2004

Tipología: Suspensión  
Typology: Pendant lamp

Ambiente: Exterior  
Environment: Outdoor

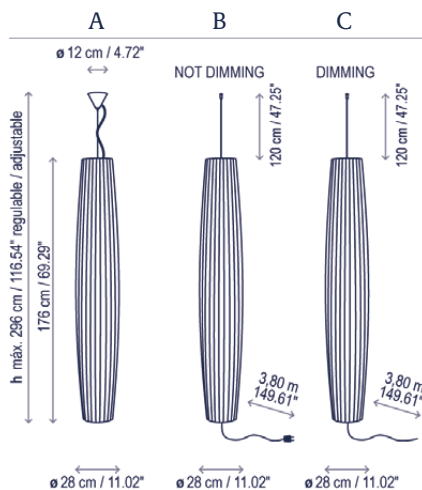

## Descripción técnica / Technical description:

Peso Neto: 6,7 kg  
Net Weight: 6,7 kg

1 Caja/Box | 35 x 33 x 201 cm | 0,2322 m<sup>3</sup>  
Peso bruto / Gross Weight: 10,51 kg

Materiales: Polietileno de media densidad,  
Hierro, Acero inoxidable.  
Medium density polyethylene, Iron, Stainless steel.

Fuente de luz protegida por pantalla de polietileno y protección UV.  
Light source protected by UV resistant polyethylene shade.

Cable sin interruptor de neopreno negro resistente al agua.  
Black waterproof neoprene cable without switch.

\*Consulte la tabla de reguladores TRIAC recomendados en la página 212.  
\*Please check the list of recommended TRIAC dimmers at page 212.

No personalizable  
Not customizable

Bombillas no incluidas  
Bulbs not included

Certificaciones  
Certifications

Recambios / Spare parts:

RSUSP Suspensión / Suspension  
R907007 Cable Neopreno / Neoprene Cable

## Descripción lámpara / Lamps description:

230V 50Hz | IP-66 | 2 x 28W T5 HE

Ref	Acabados / Finishing	Ean13	Euros
4429500TOP	Instalación Superior (A) Pantalla Polietileno Blanco Upper Installation - White Polyethylene Shade	8436047309950	703,00
4429500INF	Instalación Inferior (B) Pantalla Polietileno Blanco - Con Clavija Bottom Installation - White Polyethylene Shade - Whith Plug	8436047309967	703,00

## Descripción lámpara / Lamps description:

230V 50Hz | IP-66 | 49,2 W LED / CRI: 90 / 2700°K  
7500 lm fuente de luz / light source

Ref	Acabados / Finishing	Ean13	Euros
2950120100	LED - Instalación Superior (A) Pantalla Polietileno Blanco LED - Upper Installation White Polyethylene Shade	8436544895772	896,00
2950220100	LED - Instalación Inferior (B) Pantalla Polietileno Blanco - Con Clavija LED - Bottom Installation White Polyethylene Shade - Whith Plug	8436544895840	896,00

## Descripción lámpara / Lamps description:

230V 50Hz | IP-66 | TRIAC 49,2 W LED / CRI: 90 / 2700°K  
7500 lm fuente de luz / light source

Ref	Acabados / Finishing	Ean13	Euros
*2950121400	LED Regulable Triac - Instalación Superior (A) Pantalla Polietileno Blanco LED Dimmable Triac - Upper Installation White Polyethylene Shade	8436544892474	1.054,00
*2950221400	LED Regulable Triac - Instalación Inferior (C) Pantalla Polietileno Blanco - Sin Clavija LED Dimmable Triac - Bottom Installation White Polyethylene Shade - Whithout Plug	8436544893013	1.054,00

## Familia / Family: Maxi

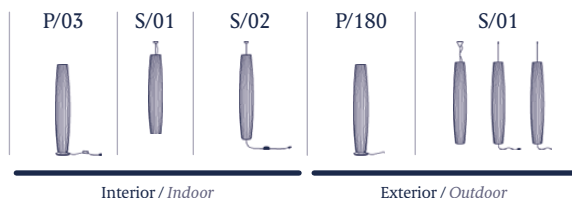

# Mediterrània S/105/01

Diseño / Design:  
Alex Fernández Camps / 2019

Tipología: Suspensión  
Typology: Pendant lamp

Ambiente: Interior  
Environment: Indoor

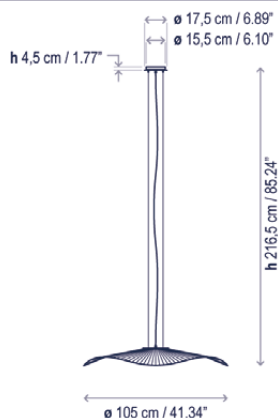

## Descripción técnica / Technical description:

Peso Neto: 3,45 kg  
Net Weight: 3,45 kg

1 Caja/Box | 116 x 116 x 31 cm | 0,4171 m<sup>3</sup>  
Peso bruto / Gross Weight: 5,75 kg

Materiales: Hierro, Aluminio  
Materials: Iron, Aluminum

Difusor inferior: Policarbonato  
Lower diffuser: Polycarbonate

Cable eléctrico transparente. Cables tensores de acero inoxidable.  
Transparent electrical cable. Stainless steel tensor cables.

Personalizable: color de la cinta y acabado  
Customizable: color of the ribbon and finish

Tejido pantalla: Poliester  
Shade fabric: Polyester

Hilo incandescente pantalla: 960°  
Shade GWFI: 960°

Certificaciones  
Certifications

## Descripción lámpara / Lamps description:

230V 50Hz IP-20 0/1-10V / DALI / PUSH 19,3 W LED / CRI: 90 / 2700°K 2900 lm fuente de luz / light source

Ref	Acabados / Finishing	Ean13	Euros
33801219054	Regulable 0/1-10v/Dali/Push - Blanco Pantalla Cinta Translúcida Blanca Dimmable 0/1-10v/Dali/Push White Translucent Ribbon Shade	8435493731490	854,00
33801219053	Regulable 0/1-10v/Dali/Push - Blanco Pantalla Cinta Translúcida Crema Dimmable 0/1-10v/Dali/Push Cream Translucent Ribbon Shade	8435493731421	854,00

Familia / Family: Mediterrània



# Mediterrània S/105/02

Diseño / Design:  
Alex Fernández Camps / 2019

Tipología: Suspensión  
Typology: Pendant lamp

Ambiente: Interior  
Environment: Indoor

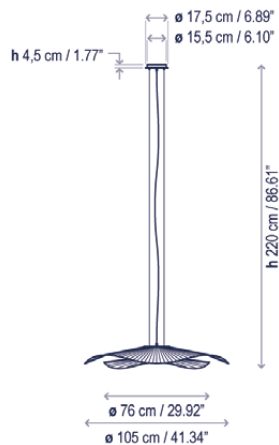

## Descripción técnica / Technical description:

Peso Neto: 4,7 kg  
Net Weight: 4,7 kg

1 Caja/Box | 116 x 116 x 31 cm | 0,4171 m<sup>3</sup>  
Peso bruto / Gross Weight: 8 kg

Materiales: Hierro, Aluminio  
Materials: Iron, Aluminum

Difusor inferior: Policarbonato  
Lower diffuser: Polycarbonate

Cable eléctrico transparente. Cables tensores de acero inoxidable.  
Transparent electrical cable. Stainless steel tensor cables.

Personalizable: color de la cinta y acabado  
Customizable: color of the ribbon and finish

Tejido pantalla: Poliester  
Shade fabric: Polyester

Hilo incandescente pantalla: 960°  
Shade GWFI: 960°

Certificaciones  
Certifications

## Descripción lámpara / Lamps description:

230V 50Hz | IP-20 | 0/1-10V / DALI / PUSH | 19,3 W LED / CRI: 90 / 2700°K | 2900 lm fuente de luz / light source

Ref	Acabados / Finishing	Ean13	Euros
33802219054	Regulable 0/1-10v/Dali/Push - Blanco Pantalla Cinta Translúcida Blanca Dimmable 0/1-10v/Dali/Push White Translucent Ribbon Shade	8435493732107	1.181,00
33802219053	Regulable 0/1-10v/Dali/Push - Blanco Pantalla Cinta Translúcida Crema Dimmable 0/1-10v/Dali/Push Cream Translucent Ribbon Shade	8435493731582	1.181,00

Familia / Family: Mediterrània



# Mei 38

Diseño / Design:  
Joana Bover / 2004

Tipología: Suspensión  
Typology: Pendant lamp

Ambiente: Interior  
Environment: Indoor

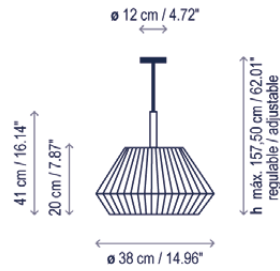

## Descripción técnica / Technical description:

Peso Neto: 1,03 kg  
Net Weight: 1,03 kg

1 Caja/Box | 40 x 40 x 25 cm | 0,04 m<sup>3</sup>  
Peso bruto / Gross Weight: 1,64 kg

Materiales: Hierro  
Materials: Iron

Difusor inferior: PVC 500  
Lower diffuser: PVC 500

Cable eléctrico transparente  
Transparent electrical cable

Hilo incandescente pantalla: 960°  
Shade GWFI: 960°

Hilo incandescente difusor: 800°  
Diffuser GWFI: 800°

Personalizable  
Customizable

Bombillas no incluidas  
Bulbs not included

Certificaciones  
Certifications

Recambios / Spare parts:

R38DIF Difusor / Diffuser  
R38 Sujeción Difusor / Diffuser Hooks

## Descripción lámpara / Lamps description:

230V 50Hz | IP-20 | 1 x 46 W EcoClassic P45 E-27 | 1 x 11 W CFL E-27 | 1 x 9 W LED A60 E-27

Ref	Acabados / Finishing	Ean13	Euros
4219905/P505C	Níquel Satinado Pantalla Cinta Translúcida Blanca Satin Nickel - White Translucent Ribbon Shade	8435493711119	258,00
4219905/P504C	Níquel Satinado Pantalla Cinta Translúcida Crema Satin Nickel - Cream Translucent Ribbon Shade	8435493711102	258,00

## Familia / Family: Mei

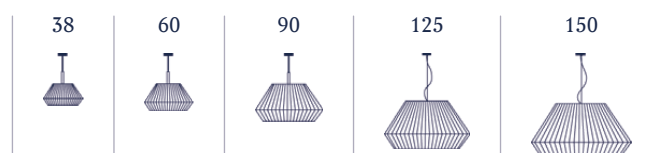

# Mei 60

Diseño / Design:  
Joana Bover / 2004

Tipología: Suspensión  
Typology: Pendant lamp

Ambiente: Interior  
Environment: Indoor

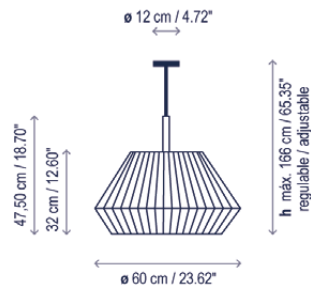

## Descripción técnica / Technical description:

Peso Neto: 1,92 kg  
Net Weight: 1,92 kg

1 Caja/Box | 61 x 61 x 40 cm | 0,1488 m<sup>3</sup>  
Peso bruto / Gross Weight: 4,1 kg

Materiales: Hierro  
Materials: Iron

Difusor inferior: PVC 500  
Lower diffuser: PVC 500

Cable eléctrico transparente  
Transparent electrical cable

Hilo incandescente pantalla: 960°  
Shade GWFI: 960°

Hilo incandescente difusor: 800°  
Diffuser GWFI: 800°

Personalizable  
Customizable

Bombillas no incluidas  
Bulbs not included

Certificaciones  
Certifications

Recambios / Spare parts:

R60DIF Difusor / Diffuser  
R60 Sujeción Difusor / Diffuser Hooks

## Descripción lámpara / Lamps description:

230V 50Hz | IP-20 | 1 x 77 W EcoClassic A55 E-27 | 1 x 18 W CFL E-27 | 1 x 9 W LED A60 E-27

Ref	Acabados / Finishing	Ean13	Euros
4119905/P503C	Níquel Satinado Pantalla Cinta Translúcida Blanca Satin Nickel - White Translucent Ribbon Shade	8435493710440	324,00
4119905/P502C	Níquel Satinado Pantalla Cinta Translúcida Crema Satin Nickel - Cream Translucent Ribbon Shade	8435493710433	324,00

Familia / Family: Mei

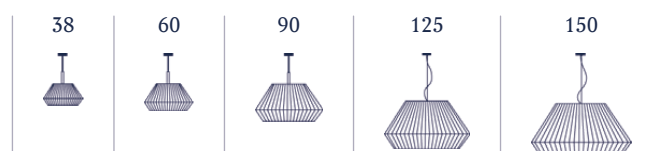



# Mei 90

Diseño / Design:  
Joana Bover / 2004

Tipología: Suspensión  
Typology: Pendant lamp

Ambiente: Interior  
Environment: Indoor

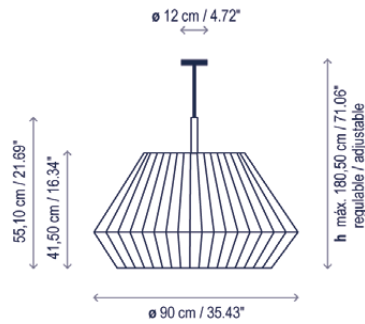

## Descripción técnica / Technical description:

Peso Neto: 4,36 kg  
Net Weight: 4,36 kg

1 Caja/Box | 96 x 96 x 45 cm | 0,4147 m<sup>3</sup>  
Peso bruto / Gross Weight: 6,62 kg

Materiales: Hierro  
Materials: Iron

Difusor inferior: PVC 500  
Lower diffuser: PVC 500

Cable eléctrico transparente  
Transparent electrical cable

Hilo incandescente pantalla: 960°  
Shade GWFI: 960°

Hilo incandescente difusor: 800°  
Diffuser GWFI: 800°

Personalizable  
Customizable

Bombillas no incluidas  
Bulbs not included

Certificaciones  
Certifications

Recambios / Spare parts:

R90DIF Difusor / Diffuser  
R90 Sujeción Difusor / Diffuser Hooks

## Descripción lámpara / Lamps description:

230V 50Hz | IP-20 | 5 x 77 W EcoClassic A55 E-27 | 5 x 22 W CFL E-27 | 5 x 9 W LED A60 E-27

Ref	Acabados / Finishing	Ean13	Euros
4419905/P490C	Níquel Satinado Pantalla Cinta Translúcida Blanca Satin Nickel - White Translucent Ribbon Shade	8435493712475	614,00
4419905/P491C	Níquel Satinado Pantalla Cinta Translúcida Crema Satin Nickel - Cream Translucent Ribbon Shade	8435493712482	614,00

## Familia / Family: Mei

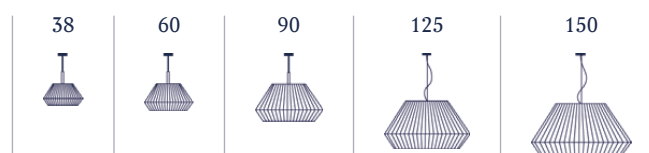

# Mei 125

Diseño / Design:  
Joana Bover / 2004

Tipología: Suspensión  
Typology: Pendant lamp

Ambiente: Interior  
Environment: Indoor

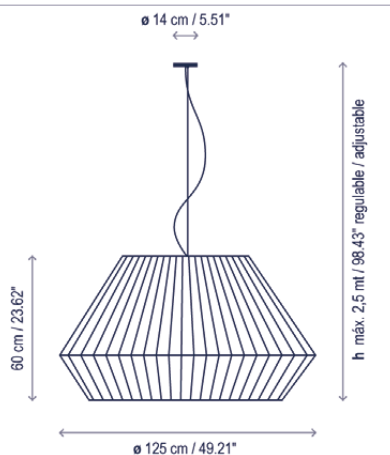

## Descripción técnica / Technical description:

Peso Neto: 6,86 kg  
Net Weight: 6,86 kg

1 Caja/Box | 135 x 135 x 67 cm | 1,2211 m<sup>3</sup>  
Peso bruto / Gross Weight: 15,26 kg

Materiales: Hierro  
Materials: Iron

Difusor inferior: PVC 500  
Lower diffuser: PVC 500

Cable eléctrico transparente. Cable tensor de acero inoxidable.  
Transparent electrical cable. Stainless steel tensor cable.

Hilo incandescente pantalla: 960°  
Shade GWF1: 960°

Hilo incandescente difusor: 800°  
Diffuser GWF1: 800°

Personalizable  
Customizable

Bombillas no incluidas  
Bulbs not included

Certificaciones  
Certifications

## Recambios / Spare parts:

R411301 Tensor 1,5 m / Tensor 1,5 m  
R411303 Tensor 3 m / Tensor 3 m  
R411305 Tensor 5 m / Tensor 5 m  
R125DIF Difusor / Diffuser  
R125 Sujeción Difusor / Diffuser Hooks  
R907001 Manguera 3x0,75 / Cable 3x0,75

## Descripción lámpara / Lamps description:

230V 50Hz IP-20 5 x 77 W EcoClassic A55 E-27 5 x 22 W CFL E-27 5 x 9 W LED A60 E-27

Ref	Acabados / Finishing	Ean13	Euros
4719905/P720C	Níquel Satinado Pantalla Cinta Translúcida Blanca Satin Nickel - White Translucent Ribbon Shade	8435493713199	1.354,00
4719905/P721C	Níquel Satinado Pantalla Cinta Translúcida Crema Satin Nickel - Cream Translucent Ribbon Shade	8435493713205	1.354,00

## Familia / Family: Mei

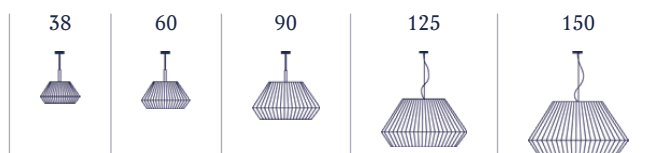

# Mei 150

Diseño / Design:  
Joana Bover / 2004

Tipología: Suspensión  
Typology: Pendant lamp

Ambiente: Interior  
Environment: Indoor

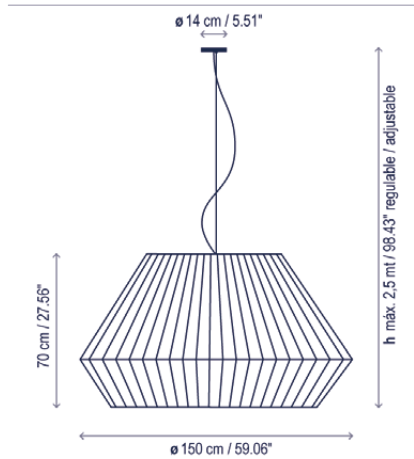

## Descripción técnica / Technical description:

Peso Neto: 13,75 kg  
Net Weight: 13,75 kg

1 Caja/Box | 157 x 157 x 77 cm | 1,898 m<sup>3</sup>  
Peso bruto / Gross Weight: 22 kg

Materiales: Hierro  
Materials: Iron

Difusor inferior: PVC 500  
Lower diffuser: PVC 500

Cable eléctrico transparente. Cable tensor de acero inoxidable.  
Transparent electrical cable. Stainless steel tensor cable.

Hilo incandescente pantalla: 960°  
Shade GWFI: 960°

Hilo incandescente difusor: 800°  
Diffuser GWFI: 800°

Personalizable  
Customizable

Bombillas no incluidas  
Bulbs not included

Certificaciones  
Certifications

## Recambios / Spare parts:

R411301 Tensor 1,5 m / Tensor 1,5 m  
R411303 Tensor 3 m / Tensor 3 m  
R411305 Tensor 5 m / Tensor 5 m  
R150DIF Difusor / Diffuser  
R150 Sujeción Difusor / Diffuser Hooks  
R907001 Manguera 3x0,75 / Cable 3x0,75

## Descripción lámpara / Lamps description:



Ref	Acabados / Finishing	Ean13	Euros
4619905/P590C	Níquel Satinado Pantalla Cinta Translúcida Blanca Satin Nickel - White Translucent Ribbon Shade	8435493713014	1.759,00
4619905/P591C	Níquel Satinado Pantalla Cinta Translúcida Crema Satin Nickel - Cream Translucent Ribbon Shade	8435493713021	1.759,00

## Familia / Family: Mei

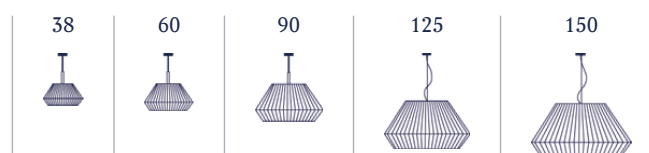

# Mei 100

Diseño / Design:  
Joana Bover / 2004

Tipología: Suspensión  
Typology: Pendant lamp

Ambiente: Interior  
Environment: Indoor

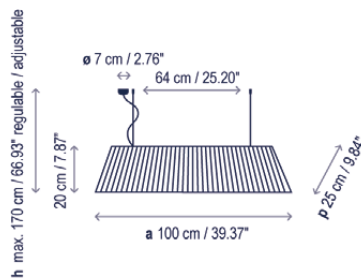

## Descripción técnica / Technical description:

Peso Neto: 2,3 kg  
Net Weight: 2,3 kg

1 Caja/Box | 31 x 108 x 31 cm | 0,1038 m<sup>3</sup>  
Peso bruto / Gross Weight: 3,75 kg

Materiales: Hierro  
Materials: Iron

Difusor inferior: PVC 500  
Lower diffuser: PVC 500

El florón independiente del cable tensor proporciona flexibilidad en la instalación.  
Floating canopy allows for flexible installation.

Cable eléctrico transparente. Cables tensores de acero inoxidable.  
Transparent electrical cable. Stainless steel tensor cables.

Hilo incandescente pantalla / Shade GWF1

Cinta / Ribbon: 960°  
Cotonet / Cotton: 800°

Hilo incandescente difusor / Diffuser GWF1: 800°

Personalizable  
Customizable

Bombillas no incluidas  
Bulbs not included

Certificaciones  
Certifications

Recambios / Spare parts:

R411301 Tensor 1,5 m / Tensor 1,5 m  
R411303 Tensor 3 m / Tensor 3 m  
R411305 Tensor 5 m / Tensor 5 m  
R100DIF Difusor / Diffuser  
R100 Sujeción Difusor / Diffuser Hooks  
RSUSP Suspensión / Suspension  
R907001 Manguera 3x0,75 / Cable 3x0,75

## Descripción lámpara / Lamps description:

230V 50Hz | IP-20 | 3 x 46 W EcoClassic P45 E-27 | 3 x 11 W CFL Mini Twist E-27 | 3 x 6 W LED P45 E-27

Ref	Acabados / Finishing	Ean13	Euros
4319905/P584C	Níquel Satinado Pantalla Cinta Translúcida Blanca Satin Nickel - White Translucent Ribbon Shade	8435493711843	436,00
4319905/P497C	Níquel Satinado Pantalla Cinta Translúcida Crema Satin Nickel - Cream Translucent Ribbon Shade	8435493711911	436,00
4319905/P498C	Níquel Satinado - Pantalla Cotonet Satin Nickel - Cotton Shade	8435493711850	351,00

Familia / Family: Mei

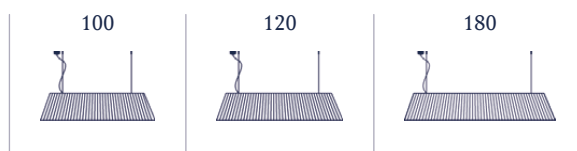

# Mei 120

Diseño / Design:  
Joana Bover / 2004

Tipología: Suspensión  
Typology: Pendant lamp

Ambiente: Interior  
Environment: Indoor

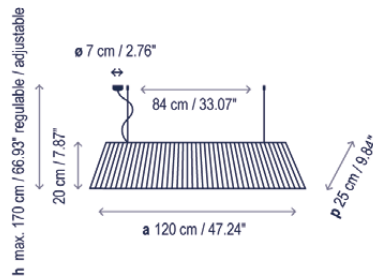

## Descripción técnica / Technical description:

Peso Neto: 2,87 kg  
Net Weight: 2,87 kg

1 Caja/Box | 28 x 29 x 132 cm | 0,1072 m<sup>3</sup>  
Peso bruto / Gross Weight: 3,62 kg

Materiales: Hierro  
Materials: Iron

Difusor inferior: PVC 500  
Lower diffuser: PVC 500

El florón independiente del cable tensor proporciona flexibilidad en la instalación.  
Floating canopy allows for flexible installation.

Cable eléctrico transparente. Cables tensores de acero inoxidable.  
Transparent electrical cable. Stainless steel tensor cables.

Hilo incandescente pantalla / Shade GWF I

Cinta / Ribbon: 960°  
Cottonet / Cotton: 800°

Hilo incandescente difusor / Diffuser GWF I: 800°

Personalizable  
Customizable

Bombillas no incluidas  
Bulbs not included

Certificaciones  
Certifications

Recambios / Spare parts:

R411301 Tensor 1,5 m / Tensor 1,5 m  
R411303 Tensor 3 m / Tensor 3 m  
R411305 Tensor 5 m / Tensor 5 m  
R120DIF Difusor / Diffuser  
R100 Sujeción Difusor / Diffuser Hooks  
RSUSP Suspensión / Suspension  
R907001 Manguera 3x0,75 / Cable 3x0,75

## Descripción lámpara / Lamps description:

230V 50Hz IP-20 5 x 46 W EcoClassic P45 E-27 5 x 11 W CFL Mini Twist E-27 5 x 6 W LED P45 E-27

Ref	Acabados / Finishing	Ean13	Euros
4519905/P514C	Níquel Satinado Pantalla Cinta Translúcida Blanca Satin Nickel - White Translucent Ribbon Shade	8435493712741	518,00
4519905/P510C	Níquel Satinado Pantalla Cinta Translúcida Crema Satin Nickel - Cream Translucent Ribbon Shade	8435493712710	518,00
4519905/P511C	Níquel Satinado - Pantalla Cottonet Satin Nickel - Cotton Shade	8435493712727	494,00

Familia / Family: Mei

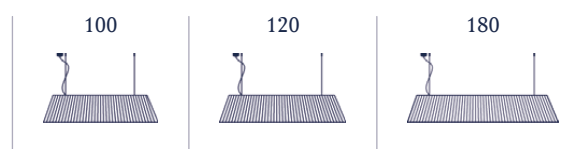

# Mei 180

Diseño / Design:  
Joana Bover / 2004

Tipología: Suspensión  
Typology: Pendant lamp

Ambiente: Interior  
Environment: Indoor

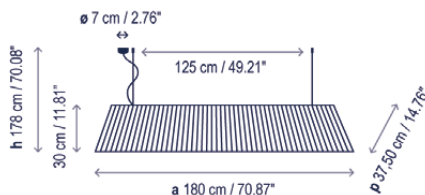

## Descripción técnica / Technical description:

Peso Neto: 7,05 kg  
Net Weight: 7,05 kg

2 Cajas / 2 Boxes:

1 Caja/Box | 29 x 29 x 172 cm | 0,1447 m<sup>3</sup>  
Peso bruto / Gross Weight: 1,75 kg

1 Caja/Box | 37 x 41 x 201 cm | 0,3049 m<sup>3</sup>  
Peso bruto / Gross Weight: 10,88 kg

Materiales: Hierro  
Materials: Iron

Difusor inferior: PVC 500  
Lower diffuser: PVC 500

El florón independiente del cable tensor proporciona flexibilidad en la instalación.  
Floating canopy allows for flexible installation.

Cable eléctrico transparente. Cables tensores de acero inoxidable.  
Transparent electrical cable. Stainless steel tensor cables.

Hilo incandescente pantalla / Shade GWF1

Cinta / Ribbon: 960°  
Cottonet / Cotton: 800°

Hilo incandescente difusor / Diffuser GWF1: 800°

Personalizable  
Customizable

Bombillas no incluidas  
Bulbs not included

Certificaciones  
Certifications

Recambios / Spare parts:

R411301 Tensor 1,5 m / Tensor 1,5 m  
R411303 Tensor 3 m / Tensor 3 m  
R411305 Tensor 5 m / Tensor 5 m  
RSUSP Suspensión / Suspension  
R907001 Manguera 3x0,75 / Cable 3x0,75

## Descripción lámpara / Lamps description:

230V 50Hz | IP-20 | 6 x 46 W EcoClassic P45 E-27 | 6 x 11 W CFL Mini Twist E-27 | 6 x 6 W LED P45 E-27

Ref	Acabados / Finishing	Ean13	Euros
430319905/P759C	Níquel Satinado Pantalla Cinta Translúcida Blanca Satin Nickel - White Translucent Ribbon Shade	8435493711492	1.317,00
430319905/P756C	Níquel Satinado Pantalla Cinta Translúcida Crema Satin Nickel - Cream Translucent Ribbon Shade	8435493711461	1.317,00
430319905/P757C	Níquel Satinado - Pantalla Cottonet Satin Nickel - Cotton Shade	8435493711478	720,00

Familia / Family: Mei

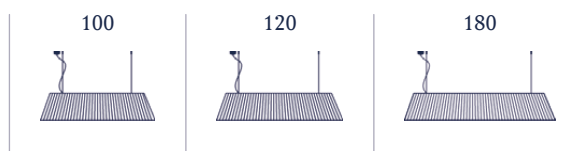



# Moai B/35 Outdoor

Diseño / Design:  
Gonzalo Milà / 2017

Tipología: Baliza  
Typology: Bollard

Ambiente: Exterior  
Environment: Outdoor

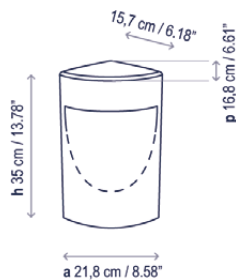

## Descripción técnica / Technical description:

 Peso Neto: 12,86 kg  
Net Weight: 12,86 kg

 1 Caja/Box | 48 x 27 x 29 cm | 0,0376 m<sup>3</sup>  
Peso bruto / Gross Weight: 14,75 kg

Materiales: Hierro, Cemento, Acero inoxidable 316.  
Materials: Iron, Concrete, 316 Stainless steel.

Baliza con dos opciones de sujeción:

1. Fijación a suelo, tornillería y tacos no incluidos.
2. Fijación por cimentación, accesorio de anclaje no incluido.

Two anchoring options:

1. Anchoring to ground, screws and anchors not included.
2. Anchoring for foundation, fasteners accessories not included.

Consulte la tabla de reguladores TRIAC recomendados en la página 212.  
Please check the list of recommended TRIAC dimmers at page 212.

No personalizable  
Not customizable

Nota: para proyectos consultar opción poliuretano.  
Note: for projects consult polyurethane option.

Certificaciones  
Certifications  

Accesorios / Accessories:

R19213 Anclaje / Anchorage

## Descripción lámpara / Lamps description:

  230V 50Hz | IP-66 | IK 8 |  TRIAC |  6,5 W LED / CRI: 90 / 2700°K | 850 lm fuente de luz / light source

Ref	Acabados / Finishing	Ean13	Euros
1920140094	Regulable Triac - Cemento Gris Dimmable Triac - Grey Concrete	8436544898094	684,00

Familia / Family: Moai

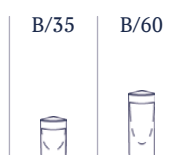

# Moai B/60 Outdoor

Diseño / Design:  
Gonzalo Milà / 2017

Tipología: Baliza  
Typology: Bollard

Ambiente: Exterior  
Environment: Outdoor

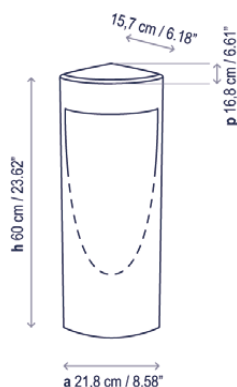

## Descripción técnica / Technical description:

Peso Neto: 20,62 kg  
Net Weight: 20,62 kg

1 Caja/Box | 73 x 26 x 24 cm | 0,0456 m<sup>3</sup>  
Peso bruto / Gross Weight: 26,44 kg

Materiales: Hierro, Cemento, Acero inoxidable 316.

Materials: Iron, Concrete, 316 Stainless steel.

Baliza con dos opciones de sujeción:

1. Fijación a suelo, tornillería y tacos no incluidos.
2. Fijación por cimentación, accesorio de anclaje no incluido.

Two anchoring options:

1. Anchoring to ground, screws and anchors not included.
2. Anchoring for foundation, fasteners accessories not included.

Consulte la tabla de reguladores TRIAC recomendados en la página 212.

Please check the list of recommended TRIAC dimmers at page 212.

No personalizable  
Not customizable

Nota: para proyectos consultar opción poliuretano.

Note: for projects consult polyurethane option.

Certificaciones  
Certifications

Accesorios / Accessories:

R19213 Anclaje / Anchorage

## Descripción lámpara / Lamps description:

230V 50Hz | IP-66 | IK 8 | 6,5 W LED / CRI: 90 / 2700°K | 850 lm fuente de luz / light source

Ref	Acabados / Finishing	Ean13	Euros
1920240094	Regulable Triac - Cemento Gris Dimmable Triac - Grey Concrete	8436544898087	770,00

Familia / Family: Moai

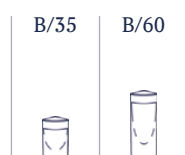

# Mod PF/73/3L

Diseño / Design:  
Lázaro Rosa-Violán / 2019

Tipología: Plafón  
Typology: Ceiling lamp

Ambiente: Interior  
Environment: Indoor

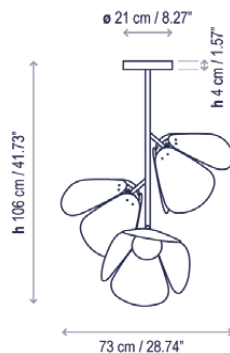
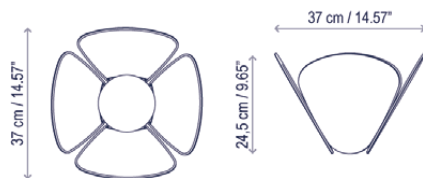

## Descripción técnica / Technical description:

Peso Neto: 6,41 kg  
Net Weight: 6,41 kg

1 Caja/Box | 90 x 39 x 30 cm | 0,1053 m<sup>3</sup>  
Peso bruto / Gross Weight: 9,12 kg

Materiales: Hierro, aluminio  
Materials: Iron, Aluminum

Difusor: Polietileno de media densidad  
Diffuser: Medium density polyethylene

La posición de la luminaria es fija  
Each shade is in a fixed position

Consulte la tabla de reguladores TRIAC recomendados en la página 212.  
Please check the list of recommended TRIAC dimmers at page 212.

Personalizable: acabado  
Customizable: finishing

Certificaciones  
Certifications

## Descripción lámpara / Lamps description:

230V 50Hz | IP-20 | TRIAC | 9 W LED / CRI: 90 / 2700°K | 1035 lm fuente de luz / light source

Ref	Acabados / Finishing	Ean13	Euros
26631105013	Regulable Triac - Blanco Pantalla Metal Blanco Dimmable Triac - White Metal White Shade	8435493730769	683,00
26632105013	Regulable Triac - Blanco Pantalla Perforada Blanco Dimmable Triac - White Perforated White Shade	8435493730776	778,00
26632105079	Regulable Triac - Beige Perlado Pantalla Perforada Latón Envejecido Dimmable Triac - Pearl Beige Perforated Antique Brass Shade	8435493730783	956,00
26633105013	Regulable Triac - Blanco Pantalla Fibra Natural Cosida Dimmable Triac - White Hand-Sewn Natural Fiber Shade	8435493730790	981,00
26634105261	Regulable Triac - Blanco Pantalla Crochet Gris Dimmable Triac - White Grey Crochet Shade	8435493730806	1.224,00

## Familia / Family: Mod

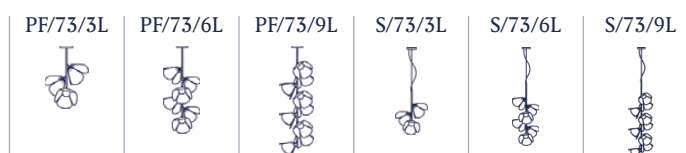

# Mod PF/73/6L

Diseño / Design:  
Lázaro Rosa-Violán / 2019

Tipología: Plafón  
Typology: Ceiling lamp

Ambiente: Interior  
Environment: Indoor

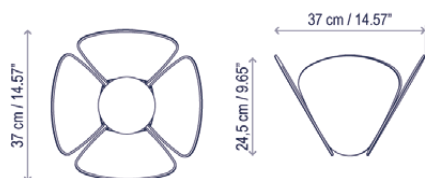

## Descripción técnica / Technical description:

Peso Neto: 6,72 kg  
Net Weight: 6,72 kg

1 Caja/Box | 163 x 36 x 30 cm | 0,176 m<sup>3</sup>  
Peso bruto / Gross Weight: 10,69 kg

Materiales: Hierro, aluminio  
Materials: Iron, Aluminum

Difusor: Polietileno de media densidad  
Diffuser: Medium density polyethylene

La posición de la luminaria es fija  
Each shade is in a fixed position

Consulte la tabla de reguladores TRIAC recomendados en la página 212.  
Please check the list of recommended TRIAC dimmers at page 212.

Personalizable: acabado  
Customizable: finishing

Certificaciones  
Certifications

## Descripción lámpara / Lamps description:

230V 50Hz | IP-20 | TRIAC | 18 W LED / CRI: 90 / 2700°K | 2070 lm fuente de luz / light source

Ref	Acabados / Finishing	Ean13	Euros
26661105013	Regulable Triac - Blanco Pantalla Metal Blanco Dimmable Triac - White Metal White Shade	8435493730813	1.167,00
26662105013	Regulable Triac - Blanco Pantalla Perforada Blanco Dimmable Triac - White Perforated White Shade	8435493730820	1.358,00
26662105079	Regulable Triac - Beige Perlado Pantalla Perforada Latón Envejecido Dimmable Triac - Pearl Beige Perforated Antique Brass Shade	8435493730837	1.755,00
26663105013	Regulable Triac - Blanco Pantalla Fibra Natural Cosida Dimmable Triac - White Hand-Sewn Natural Fiber Shade	8435493730844	1.763,00
26664105261	Regulable Triac - Blanco Pantalla Crochet Gris Dimmable Triac - White Grey Crochet Shade	8435493730851	2.193,00

## Familia / Family: Mod

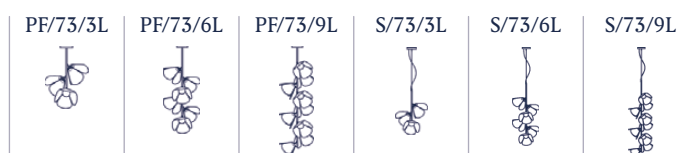

# Mod PF/73/9L

Diseño / Design:  
Lázaro Rosa-Violán / 2019

Tipología: Plafón  
Typology: Ceiling lamp

Ambiente: Interior  
Environment: Indoor

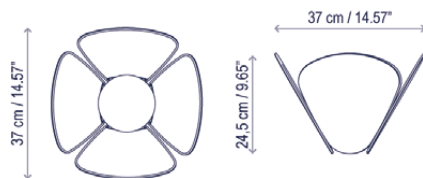

## Descripción técnica / Technical description:

Peso Neto: 16,49 kg  
Net Weight: 16,49 kg

1 Caja/Box | 213 x 34 x 30 cm | 0,2173 m<sup>3</sup>  
Peso bruto / Gross Weight: 22,12 kg

Materiales: Hierro, aluminio  
Materials: Iron, Aluminum

Difusor: Polietileno de media densidad  
Diffuser: Medium density polyethylene

La posición de la luminaria es fija  
Each shade is in a fixed position

Consulte la tabla de reguladores TRIAC recomendados en la página 212.  
Please check the list of recommended TRIAC dimmers at page 212.

Personalizable: acabado  
Customizable: finishing

Certificaciones  
Certifications

## Descripción lámpara / Lamps description:

230V 50HZ | IP-20 | TRIAC | 27 W LED / CRI: 90 / 2700°K | 3105 lm fuente de luz / light source

Ref	Acabados / Finishing	Ean13	Euros
26691105013	Regulable Triac - Blanco Pantalla Metal Blanco Dimmable Triac - White Metal White Shade	8435493730868	1.672,00
26692105013	Regulable Triac - Blanco Pantalla Perforada Blanco Dimmable Triac - White Perforated White Shade	8435493731070	1.958,00
26692105079	Regulable Triac - Beige Perlado Pantalla Perforada Latón Envejecido Dimmable Triac - Pearl Beige Perforated Antique Brass Shade	8435493730875	2.521,00
26693105013	Regulable Triac - Blanco Pantalla Fibra Natural Cosida Dimmable Triac - White Hand-Sewn Natural Fiber Shade	8435493730882	2.561,00
26694105261	Regulable Triac - Blanco Pantalla Crochet Gris Dimmable Triac - White Grey Crochet Shade	8435493730905	3.260,00

## Familia / Family: Mod

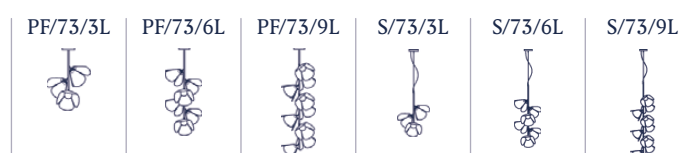

# Mod S/73/3L

Diseño / Design:  
Lázaro Rosa-Violán / 2019

Tipología: Suspensión  
Typology: Pendant lamp

Ambiente: Interior  
Environment: Indoor

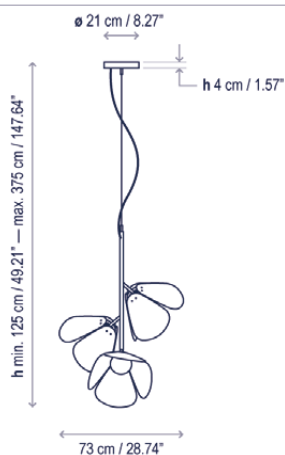
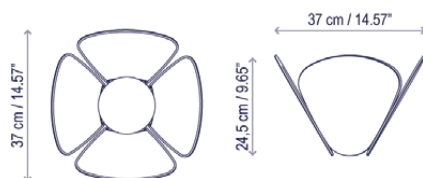

## Descripción técnica / Technical description:

Peso Neto: 6,41 kg  
Net Weight: 6,41 kg

1 Caja/Box | 90 x 39 x 30 cm | 0,1053 m<sup>3</sup>  
Peso bruto / Gross Weight: 9,12 kg

Materiales: Hierro, aluminio  
Materials: Iron, Aluminum

Difusor: Polietileno de media densidad  
Diffuser: Medium density polyethylene

La posición de la luminaria es fija  
Each shade is in a fixed position

Consulte la tabla de reguladores TRIAC recomendados en la página 212.  
Please check the list of recommended TRIAC dimmers at page 212.

Personalizable: acabado  
Customizable: finishing

Certificaciones  
Certifications

## Descripción lámpara / Lamps description:

230V 50HZ | IP-20 | TRIAC | 9 W LED / CRI: 90 / 2700°K | 1035 lm fuente de luz / light source

Ref	Acabados / Finishing	Ean13	Euros
26631215013	Regulable Triac - Blanco Pantalla Metal Blanco Dimmable Triac - White Metal White Shade	8435493724072	768,00
26632215013	Regulable Triac - Blanco Pantalla Perforada Blanco Dimmable Triac - White Perforated White Shade	8435493724089	839,00
26632215079	Regulable Triac - Beige Perlado Pantalla Perforada Latón Envejecido Dimmable Triac - Pearl Beige Perforated Antique Brass Shade	8435493724386	977,00
26633215013	Regulable Triac - Blanco Pantalla Fibra Natural Cosida Dimmable Triac - White Hand-Sewn Natural Fiber Shade	8435493724096	1.054,00
26634215261	Regulable Triac - Blanco Pantalla Crochet Gris Dimmable Triac - White Grey Crochet Shade	8435493724102	1.240,00

## Familia / Family: Mod

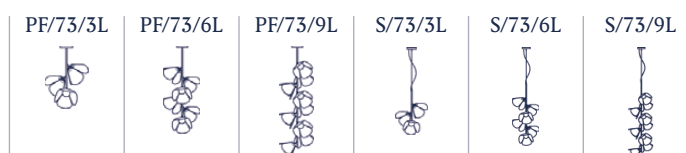



# Mod S/73/6L

Diseño / Design:  
Lázaro Rosa-Violán / 2019

Tipología: Suspensión  
Typology: Pendant lamp

Ambiente: Interior  
Environment: Indoor

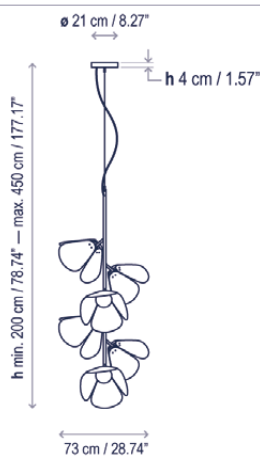
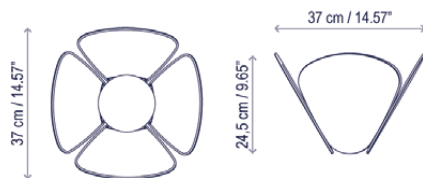

## Descripción técnica / Technical description:

Peso Neto: 6,72 kg  
Net Weight: 6,72 kg

1 Caja/Box | 163 x 36 x 30 cm | 0,176 m<sup>3</sup>  
Peso bruto / Gross Weight: 10,69 kg

Materiales: Hierro, aluminio  
Materials: Iron, Aluminum

Difusor: Polietileno de media densidad  
Diffuser: Medium density polyethylene

La posición de la luminaria es fija  
Each shade is in a fixed position

Consulte la tabla de reguladores TRIAC recomendados en la página 212.  
Please check the list of recommended TRIAC dimmers at page 212.

Personalizable: acabado  
Customizable: finishing

Certificaciones  
Certifications

## Descripción lámpara / Lamps description:

230V 50Hz | IP-20 | TRIAC | 18 W LED / CRI: 90 / 2700°K | 2070 lm fuente de luz / light source

Ref	Acabados / Finishing	Ean13	Euros
26661215013	Regulable Triac - Blanco Pantalla Metal Blanco Dimmable Triac - White Metal White Shade	8435493724119	1.260,00
26662215013	Regulable Triac - Blanco Pantalla Perforada Blanco Dimmable Triac - White Perforated White Shade	8435493724126	1.451,00
26662215079	Regulable Triac - Beige Perlado Pantalla Perforada Latón Envejecido Dimmable Triac - Pearl Beige Perforated Antique Brass Shade	8435493724393	1.767,00
26663215013	Regulable Triac - Blanco Pantalla Fibra Natural Cosida Dimmable Triac - White Hand-Sewn Natural Fiber Shade	8435493724133	1.852,00
26664215261	Regulable Triac - Blanco Pantalla Crochet Gris Dimmable Triac - White Grey Crochet Shade	8435493724140	2.294,00

## Familia / Family: Mod

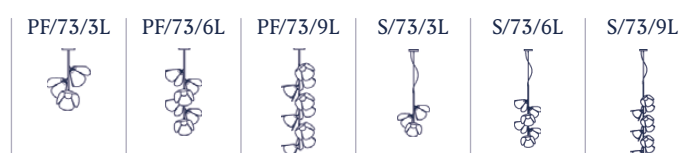

# Mod S/73/9L

Diseño / Design:  
Lázaro Rosa-Violán / 2019

Tipología: Suspensión  
Typology: Pendant lamp

Ambiente: Interior  
Environment: Indoor

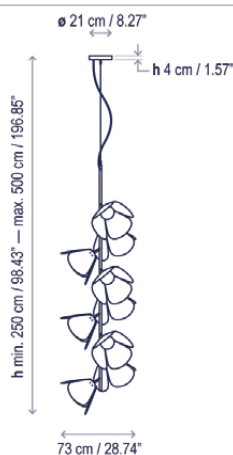
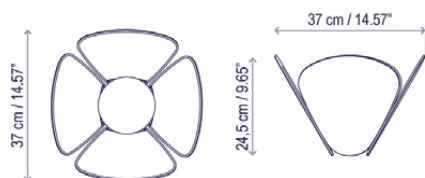

## Descripción técnica / Technical description:

Peso Neto: 16,49 kg  
Net Weight: 16,49 kg

1 Caja/Box | 213 x 34 x 30 cm | 0,2173 m<sup>3</sup>  
Peso bruto / Gross Weight: 22,12 kg

Materiales: Hierro, aluminio  
Materials: Iron, Aluminum

Difusor: Polietileno de media densidad  
Diffuser: Medium density polyethylene

La posición de la luminaria es fija  
Each shade is in a fixed position

Consulte la tabla de reguladores TRIAC recomendados en la página 212.  
Please check the list of recommended TRIAC dimmers at page 212.

Personalizable: acabado  
Customizable: finishing

Certificaciones  
Certifications

## Descripción lámpara / Lamps description:

230V 50Hz | IP-20 | TRIAC | 27 W LED / CRI: 90 / 2700°K | 3105 lm fuente de luz / light source

Ref	Acabados / Finishing	Ean13	Euros
26691215013	Regulable Triac - Blanco Pantalla Metal Blanco Dimmable Triac - White Metal White Shade	8435493724157	1.751,00
26692215013	Regulable Triac - Blanco Pantalla Perforada Blanco Dimmable Triac - White Perforated White Shade	8435493724164	2.039,00
26692215079	Regulable Triac - Beige Perlado Pantalla Perforada Latón Envejecido Dimmable Triac - Pearl Beige Perforated Antique Brass Shade	8435493724409	2.549,00
26693215013	Regulable Triac - Blanco Pantalla Fibra Natural Cosida Dimmable Triac - White Hand-Sewn Natural Fiber Shade	8435493724171	2.703,00
26694215261	Regulable Triac - Blanco Pantalla Crochet Gris Dimmable Triac - White Grey Crochet Shade	8435493724188	3.336,00

## Familia / Family: Mod

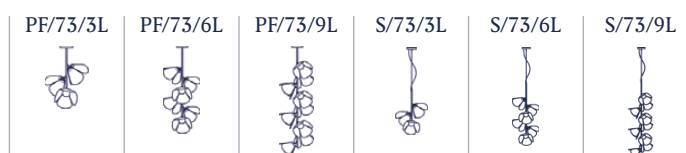

# Mos 01

Diseño / Design:  
Joana Bover / 2008

Tipología: Suspensión  
Typology: Pendant lamp

Ambiente: Interior  
Environment: Indoor

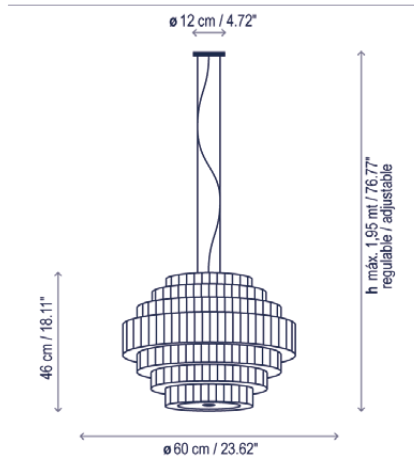

## Descripción técnica / Technical description:

Peso Neto: 5,36 kg  
Net Weight: 5,36 kg

1 Caja/Box | 61 x 61 x 50 cm | 0,1861 m<sup>3</sup>  
Peso bruto / Gross Weight: 7,48 kg

Materiales: Hierro  
Materials: Iron

Difusor inferior: Cristal óptico  
Lower diffuser: Optical glass

Cable eléctrico transparente. Cables tensores de acero inoxidable.  
Transparent electrical cable. Stainless steel tensor cables.

Hilo incandescente pantalla: 960°  
Shade GWFI: 960°

Personalizable  
Customizable

Bombillas no incluidas  
Bulbs not included

Certificaciones  
Certifications

Recambios / Spare parts:

R224DIF1 Difusor / Diffuser  
R411301 Tensor 1,5 m / Tensor 1,5 m  
R411303 Tensor 3 m / Tensor 3 m  
R411305 Tensor 5 m / Tensor 5 m  
R907001 Manguera 3x0,75 / Cable 3x0,75

## Descripción lámpara / Lamps description:

230V 50Hz IP-20 3 x 46 W EcoClassic P45 E-27 3 x 18 W CFL E-27 3 x 9 W LED A60 E-27

Ref	Acabados / Finishing	Ean13	Euros
224P617	Pantalla Cinta Translúcida Blanca White Translucent Ribbon Shade	8436047307451	950,00
224P618	Pantalla Cinta Translúcida Crema Cream Translucent Ribbon Shade	8436047307468	950,00

Familia / Family: Mos

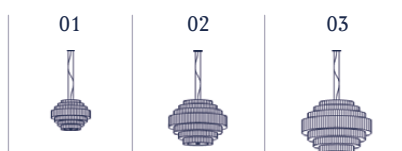

# Mos 02

Diseño / Design:  
Joana Bover / 2008

Tipología: Suspensión  
Typology: Pendant lamp

Ambiente: Interior  
Environment: Indoor

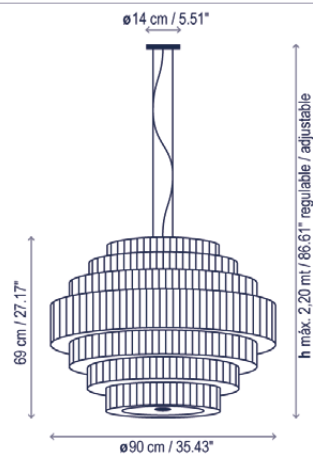

## Descripción técnica / Technical description:

Peso Neto: 12,02 kg  
Net Weight: 12,02 kg

1 Caja/Box | 106 x 97 x 75 cm | 0,7712 m<sup>3</sup>  
Peso bruto / Gross Weight: 22,16 kg

Materiales: Hierro  
Materials: Iron

Difusor inferior: Cristal óptico  
Lower diffuser: Optical glass

Cable eléctrico transparente. Cables tensores de acero inoxidable.  
Transparent electrical cable. Stainless steel tensor cables.

Hilo incandescente pantalla: 960°  
Shade GWFI: 960°

Personalizable  
Customizable

Bombillas no incluidas  
Bulbs not included

Certificaciones  
Certifications

Recambios / Spare parts:

R224DIF2 Difusor / Diffuser  
R411301 Tensor 1,5 m / Tensor 1,5 m  
R411303 Tensor 3 m / Tensor 3 m  
R411305 Tensor 5 m / Tensor 5 m  
R907001 Manguera 3x0,75 / Cable 3x0,75

## Descripción lámpara / Lamps description:

230V 50Hz IP-20 5 x 46 W EcoClassic P45 E-27 5 x 30 W CFL E-27 5 x 9 W LED A60 E-27

Ref	Acabados / Finishing	Ean13	Euros
224P622	Pantalla Cinta Translúcida Blanca White Translucent Ribbon Shade	8436047307536	1.429,00
224P623	Pantalla Cinta Translúcida Crema Cream Translucent Ribbon Shade	8436047307543	1.429,00

Familia / Family: Mos

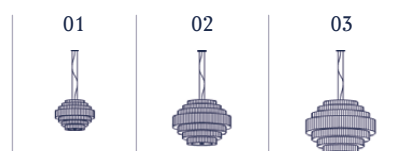

# Mos 03

Diseño / Design:  
Joana Bover / 2008

Tipología: Suspensión  
Typology: Pendant lamp

Ambiente: Interior  
Environment: Indoor

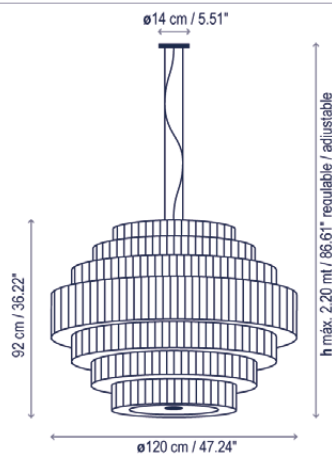

## Descripción técnica / Technical description:

Peso Neto: 17,02 kg  
Net Weight: 17,02 kg

1 Caja/Box | 124 x 124 x 110 cm | 1,6914 m<sup>3</sup>  
Peso bruto / Gross Weight: 26,27 kg

Materiales: Hierro  
Materials: Iron

Difusor inferior: Policarbonato  
Lower diffuser: Polycarbonate

Cable eléctrico transparente. Cables tensores de acero inoxidable.  
Transparent electrical cable. Stainless steel tensor cables.

Hilo incandescente pantalla: 960°  
Shade GWFI: 960°

Personalizable  
Customizable

Bombillas no incluidas  
Bulbs not included

Certificaciones  
Certifications

Recambios / Spare parts:

R224DIF3 Difusor / Diffuser  
R411301 Tensor 1,5 m / Tensor 1,5 m  
R411303 Tensor 3 m / Tensor 3 m  
R411305 Tensor 5 m / Tensor 5 m  
R907001 Manguera 3x0,75 / Cable 3x0,75

## Descripción lámpara / Lamps description:



Ref	Acabados / Finishing	Ean13	Euros
224P621	Pantalla Cinta Translúcida Blanca White Translucent Ribbon Shade	8436047304634	2.171,00
224P625	Pantalla Cinta Translúcida Crema Cream Translucent Ribbon Shade	8436047304641	2.171,00

Familia / Family: Mos

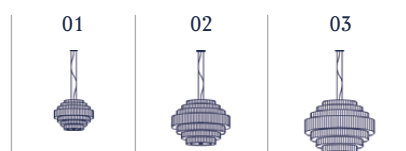

# Muf 01

Diseño / Design:  
Joana Bover / 2007

Tipología: Mesa  
Typology: Table lamp

Ambiente: Interior  
Environment: Indoor

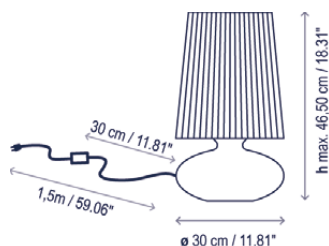

## Descripción técnica / Technical description:

1 Caja/Box | 67 x 67 x 57 cm | 0,2559 m<sup>3</sup>  
Peso bruto / Gross Weight: 7,37 kg

1 kg | Peso Neto: 3,02 kg  
Net Weight: 3,02 kg

Materiales: Cristal soplado, Hierro  
Materials: Blown glass, Iron

Lámpara con tres posiciones de encendido.  
Debido a la naturaleza del cristal soplado,  
las variaciones naturales no se consideran  
imperfecciones.

Lamp with an on/off switch that allows 3  
lighting/mood positions. Due to the nature of  
the hand blown crystal, natural variations will  
not be considered an imperfection.

Hilo incandescente pantalla / Shade GWF1  
Cinta / Ribbon: 960°

Cable eléctrico blanco  
White electrical cable

Personalizable: solo pantalla  
Customizable: shade

Bombillas no incluidas  
Bulbs not included

Certificaciones  
Certifications



## Descripción lámpara / Lamps description:

230V 50Hz | IP-20 | 1 x 46 W E-27 EcoClassic A55 + 1 x 20 W E-14 EcoClassic P45 | 1 x 9 W E-27 LED A55 + 1 x 6 W E-14 LED P45

Ref	Acabados / Finishing	Ean13	Euros
2215521/P561	Cristal Soplado Opal/Cromo Pantalla Cinta Translúcida Blanca Blown Opal Glass/Chrome White Translucent Ribbon Shade	8435493704913	403,00

Familia / Family: Muf

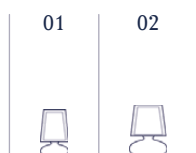



# Muf 02

Diseño / Design:  
Joana Bover / 2007

Tipología: Mesa  
Typology: Table lamp

Ambiente: Interior  
Environment: Indoor

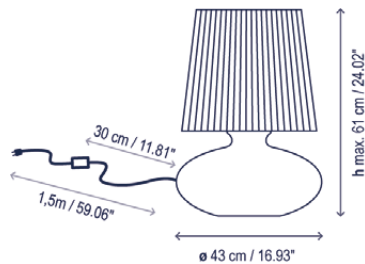

## Descripción técnica / Technical description:

1 Caja/Box | 67 x 67 x 90 cm | 0,404 m<sup>3</sup>  
Peso bruto / Gross Weight: 10,21 kg

Peso Neto: 4,82 kg  
Net Weight: 4,82 kg

Materiales: Cristal soplado, Hierro  
Materials: Blown glass, Iron

Lámpara con tres posiciones de encendido.  
Debido a la naturaleza del cristal soplado,  
las variaciones naturales no se consideran  
imperfecciones.

Lamp with an on/off switch that allows 3  
lighting/mood positions. Due to the nature of  
the hand blown crystal, natural variations will  
not be considered an imperfection.

Hilo incandescente pantalla / Shade GWF1  
Cinta / Ribbon: 960°

Cable eléctrico blanco  
White electrical cable

Personalizable: solo pantalla  
Customizable: shade

Bombillas no incluidas  
Bulbs not included

Certificaciones  
Certifications



## Descripción lámpara / Lamps description:

230V 50Hz | IP-20 | 1 x 46 W E-27 EcoClassic A55 + 2 x 20 W E-14 EcoClassic P45 | 1 x 9 W E-27 LED A55 + 2 x 6 W E-14 LED P45

Ref	Acabados / Finishing	Ean13	Euros
2215522/P580	Cristal Soplado Opal/Cromo Pantalla Cinta Translúcida Blanca Blown Opal Glass/Chrome White Translucent Ribbon Shade	8435493704975	591,00

Familia / Family: Muf

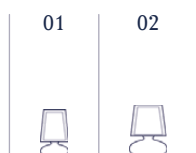

# Nón Lá A/01

Diseño / Design:  
Jorge Pensi Design Studio / 2015

Tipología: Aplique  
Typology: Wall Lamp

Ambiente: Interior  
Environment: Indoor

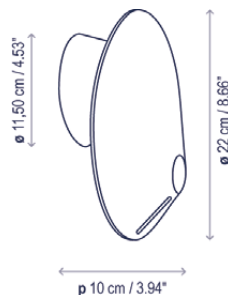

## Descripción técnica / Technical description:

Peso Neto: 1,29 kg  
Net Weight: 1,29 kg

1 Caja/Box | 29 x 29 x 22 cm | 0,0185 m<sup>3</sup>  
Peso bruto / Gross Weight: 1,82 kg

Materiales: Aluminio, Hierro  
Materials: Aluminum, Iron

Difusor: Metacrilato  
Diffuser: Methacrylate

Caja soporte: ø 11,5 cm  
Surface back box: ø 4.53"

Consulte la tabla de reguladores TRIAC recomendados en la página 212.  
Please check the list of recommended TRIAC dimmers at page 212.

Personalizable: acabado  
Customizable: finishing

Certificaciones  
Certifications

## Descripción lámpara / Lamps description:

230V 50Hz | IP-20 | TRIAC | 10,5 W LED / CRI: 90 / 2700°K | 1200 lm fuente de luz / light source

Ref	Acabados / Finishing	Ean13	Euros
*3320101301	Regulable Triac - Blanco Lacado Brillante Dimmable Triac - White Brilliant Lacquer	8436535539364	377,00
*3320101306	Regulable Triac - Cromo Dimmable Triac - Chrome	8436535539357	411,00
*3320101389	Regulable Triac - Cobre Satinado Dimmable Triac - Satin Cooper	8436535539388	411,00

## Familia / Family: Nón Lá

A/01	A/03	A/04	S	Set 3 Rectangular	T

# Nón Lá A/03

Diseño / Design:  
Jorge Pensi Design Studio / 2015

Tipología: Aplique  
Typology: Wall Lamp

Ambiente: Interior  
Environment: Indoor

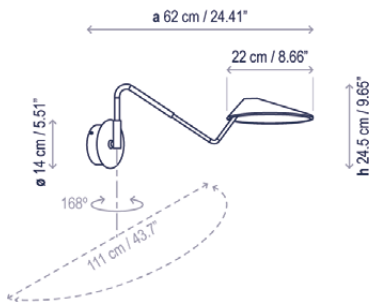

## Descripción técnica / Technical description:

Peso Neto: 1,97 kg  
Net Weight: 1,97 kg

1 Caja/Box | 32 x 32 x 66 cm | 0,0676 m<sup>3</sup>  
Peso bruto / Gross Weight: 3,28 kg

Materiales: Aluminio, Hierro fundido, Hierro  
Materials: Aluminum, Molten Iron, Iron

Difusor: Metacrilato  
Diffuser: Methacrylate

El brazo es de color marrón grafito. La pantalla varía según el acabado elegido (Blanco Lacado Brillante, Cromo, Cobre).  
Arm in Graphite Brown. Shade finished in Chrome, Copper and White Brilliant Lacquer.

Caja soporte: ø 14 cm  
Surface back box: ø 5.51"

\*Nota: el sensor proxy conserva luz azul latente cuando la lámpara está apagada. Esta luz se encuentra en la parte inferior de la pantalla.  
Note: while in off position, the blue proxy sensor is illuminated. This light is under the shade.

Consulte la tabla de reguladores TRIAC recomendados en la página 212.  
Please check the list of recommended TRIAC dimmers at page 212.

Personalizable: acabado  
Customizable: finishing

Certificaciones  
Certifications

## Descripción lámpara / Lamps description:

230V 50Hz IP-20 10,5 W LED / CRI: 90 / 2700<sup>o</sup>K  
1200 lm fuente de luz / light source

Ref	Acabados / Finishing	Ean13	Euros
*3320301601	Blanco Lacado Brillante + Interruptor Proxy Dimmer White Brilliant Lacquer + Proxy Dimmer Switch	8436544896076	506,00
*3320301606	Cromo + Interruptor Proxy Dimmer Chrome + Proxy Dimmer Switch	8436544896052	556,00
*3320301689	Cobre Satinado + Interruptor Proxy Dimmer Satin Cooper + Proxy Dimmer Switch	8436544895994	556,00
3320301301	Regulable Triac - Blanco Lacado Brillante Dimmable Triac - White Brilliant Lacquer	8436535536615	489,00
3320301306	Regulable Triac - Cromo Dimmable Triac - Chrome	8436535536745	511,00
3320301389	Regulable Triac - Cobre Satinado Dimmable Triac - Satin Cooper	8436535536752	511,00

## Familia / Family: Nón Lá

A/01	A/03	A/04	S	Set 3 Rectangular	T

# Nón Lá A/04

Diseño / Design:  
Jorge Pensi Design Studio / 2015

Tipología: Aplique  
Typology: Wall Lamp

Ambiente: Interior  
Environment: Indoor

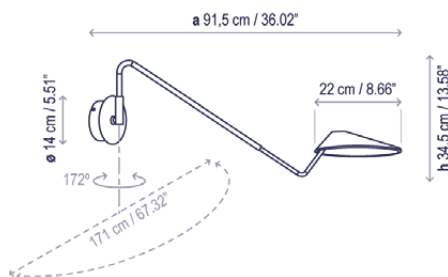

## Descripción técnica / Technical description:

Peso Neto: 2,4 kg  
Net Weight: 2,4 kg

1 Caja/Box | 109 x 25 x 25 cm | 0,0681 m<sup>3</sup>  
Peso bruto / Gross Weight: 4,17 kg

Materiales: Aluminio, Hierro fundido, Hierro  
Materials: Aluminum, Molten Iron, Iron

Difusor: Metacrilato  
Diffuser: Methacrylate

El brazo es de color marrón grafito. La pantalla varía según el acabado elegido (Blanco Lacado Brillante, Cromo, Cobre).  
Arm in Graphite Brown. Shade finished in White Brilliant Lacquer, Chrome, Copper and White Brilliant Lacquer.

Caja soporte: ø 14 cm  
Surface back box: ø 5.51"

\*Nota: el sensor proxy conserva luz azul latente cuando la lámpara está apagada. Esta luz se encuentra en la parte inferior de la pantalla.  
Note: while in off position, the blue proxy sensor is illuminated. This light is under the shade.

Consulte la tabla de reguladores TRIAC recomendados en la página 212.  
Please check the list of recommended TRIAC dimmers at page 212.

Personalizable: acabado  
Customizable: finishing

Certificaciones  
Certifications



## Descripción lámpara / Lamps description:

230V 50Hz IP-20 10,5 W LED / CRI: 90 / 2700°K  
1200 lm fuente de luz / light source

Ref	Acabados / Finishing	Ean13	Euros
*3320401601	Blanco Lacado Brillante + Interruptor Proxy Dimmer White Brilliant Lacquer + Proxy Dimmer Switch	8436544895970	514,00
*3320401606	Cromo + Interruptor Proxy Dimmer Chrome + Proxy Dimmer Switch	8436544895956	565,00
*3320401689	Cobre Satinado + Interruptor Proxy Dimmer Satin Cooper + Proxy Dimmer Switch	8436544895918	565,00
3320401301	Regulable Triac - Blanco Lacado Brillante Dimmable Triac - White Brilliant Lacquer	8436535537223	502,00
3320401306	Regulable Triac - Cromo Dimmable Triac - Chrome	8436535537247	521,00
3320401389	Regulable Triac - Cobre Satinado Dimmable Triac - Satin Cooper	8436535537261	521,00

## Familia / Family: Nón Lá

A/01	A/03	A/04	S	Set 3 Rectangular	T

# Nón Lá S

Diseño / Design:  
Jorge Pensi Design Studio / 2015

Tipología: Suspensión  
Typology: Pendant Lamp

Ambiente: Interior  
Environment: Indoor

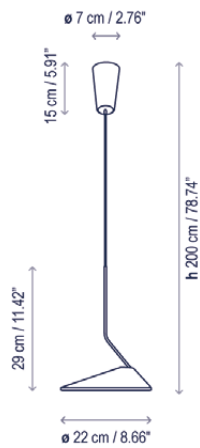

## Descripción técnica / Technical description:

Peso Neto: 1,36 kg  
Net Weight: 1,36 kg

1 Caja/Box | 28 x 28 x 41 cm | 0,0321 m<sup>3</sup>  
Peso bruto / Gross Weight: 1,96 kg

Materiales: Aluminio, Hierro  
Materials: Aluminum, Iron

Difusor: Metacrilato  
Diffuser: Methacrylate

Sistema magnético que permite fijar la posición de la pantalla.  
Magnet system to fix the shade position.

Consulte la tabla de reguladores TRIAC recomendados en la página 212.  
Please check the list of recommended TRIAC dimmers at page 212.

Personalizable: acabado  
Customizable: finishing

Certificaciones  
Certifications

Recambios / Spare parts:  
R906019N Cable coaxial / Coaxial cable

## Descripción lámpara / Lamps description:

230V 50Hz | IP-20 | 10,5 W LED / CRI: 90 / 2700°K  
1200 lm fuente de luz / light source

Ref	Acabados / Finishing	Ean13	Euros
3320121501	Regulable Triac - Blanco Lacado Brillante Florón Blanco - Cable Blanco Dimmable Triac - White Brilliant Lacquer White Canopy - White Cable	8436544890357	420,00
3320121506	Regulable Triac - Cromo Florón Cromo - Cable Transparente Dimmable Triac - Chrome Chrome Canopy - Transparent Cable	8436544890371	447,00
3320121589	Regulable Triac - Cobre Satinado Florón Cobre Satinado - Cable Negro Dimmable Triac - Satin Cooper Satin Cooper Canopy - Black Cable	8436544899992	430,00

## Familia / Family: Nón Lá

A/01	A/03	A/04	S	Set 3 Rectangular	T

# Nón Lá Set 3/Rectangular

Diseño / Design:  
Jorge Pensi Design Studio / 2015

Tipología: Suspensión  
Typology: Pendant Lamp

Ambiente: Interior  
Environment: Indoor

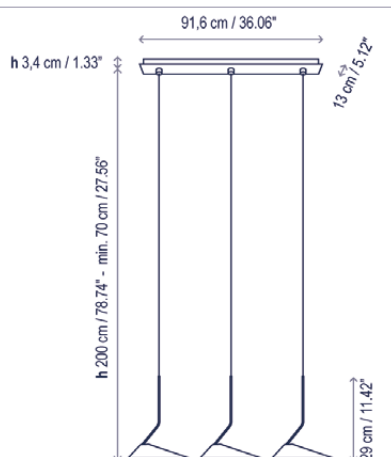

## Descripción técnica / Technical description:

Peso Neto: 6,32 kg  
Net Weight: 6,68 kg

1 Caja/Box | 53 x 103 x 41 cm | 0,2238 m<sup>3</sup>  
Peso bruto / Gross Weight: 12,22 kg

Materiales: Aluminio, Hierro  
Materials: Aluminum, Iron

Difusor: Metacrilato  
Diffuser: Methacrylate

Sistema magnético que permite fijar la posición de la pantalla.  
Magnet system to fix the shade position.

Cable coaxial  
Coaxial cable

Caja soporte: 88,6 x 11 cm  
Surface back box: 34.88" x 4.33"

Consulte la tabla de reguladores TRIAC recomendados en la página 212.  
Please check the list of recommended TRIAC dimmers at page 212.

Personalizable: acabado  
Customizable: finishing

Certificaciones  
Certifications

Recambios / Spare parts:  
R906019N Cable coaxial / Coaxial cable

## Descripción lámpara / Lamps description:

230V 50Hz IP-20 31,5 W LED / CRI: 90 / 2700°K  
3600 lm fuente de luz / light source

Ref	Acabados / Finishing	Ean13	Euros
3320421501	Regulable Triac - Blanco Lacado Brillante Florón Blanco - Cable Blanco Dimmable Triac - White Brilliant Lacquer White Canopy - White Cable	8436544890838	1.282,00
3320421506	Regulable Triac - Cromo Florón Blanco - Cable Transparente Dimmable Triac - Chrome White Canopy - Transparent Cable	8436544890845	1.339,00
3320421589	Regulable Triac - Cobre Satinado Florón Negro - Cable Negro Dimmable Triac - Satin Cooper Black Canopy - Black Cable	8436544891064	1.339,00

Familia / Family: Nón Lá

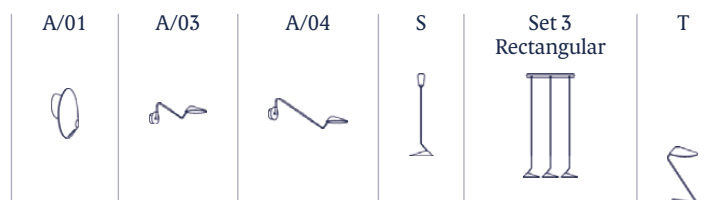



# Nón Lá T

Diseño / Design:  
Jorge Pensi Design Studio / 2015

Tipología: Mesa  
Typology: Table Lamp

Ambiente: Interior  
Environment: Indoor



Driver Connector

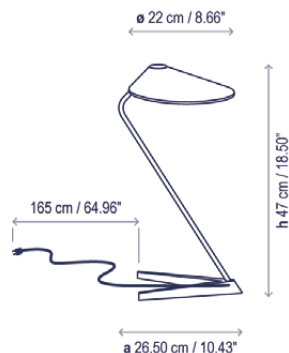

## Descripción técnica / Technical description:

Peso Neto: 2,01 kg  
Net Weight: 2,01 kg

1 Caja/Box | 39 x 35 x 53 cm | 0,0723 m<sup>3</sup>  
Peso bruto / Gross Weight: 4,55 kg

Materiales: Aluminio, Hierro fundido, Hierro  
Materials: Aluminum, Molten Iron, Iron

Difusor: Metacrilato  
Diffuser: Methacrylate

El brazo es de color marrón grafito. La pantalla varía según el acabado elegido (Blanco Lacado Brillante, Cromo, Cobre).  
Arm in Graphite Brown. Shade finished in Chrome, Copper and White Brilliant Lacquer.

Cable eléctrico negro  
Black electrical cable

\*Nota: el sensor proxy conserva luz azul latente cuando la lámpara está apagada. Esta luz se encuentra en la parte inferior de la pantalla.  
Note: while in off position, the blue proxy sensor is illuminated. This light is under the shade.

Consulte la tabla de reguladores TRIAC recomendados en la página 212.  
Please check the list of recommended TRIAC dimmers at page 212.

Personalizable: acabado  
Customizable: finishing

Certificaciones  
Certifications

## Descripción lámpara / Lamps description:

100-240V 50/60Hz IP-20 10,5 W LED / CRI: 90 / 2700°K 1200 lm fuente de luz / light source

Ref	Acabados / Finishing	Ean13	Euros
3320130301	Blanco Lacado Brillante + Interruptor Proxy Dimmer White Brilliant Lacquer + Proxy Dimmer Switch	8436535534987	642,00
3320130306	Cromo + Interruptor Proxy Dimmer Chrome + Proxy Dimmer Switch	8436535534994	584,00
3320130389	Cobre Satinado + Interruptor Proxy Dimmer Satin Copper + Proxy Dimmer Switch	8436535536325	650,00

## Familia / Family: Nón Lá

A/01	A/03	A/04	S	Set 3 Rectangular	T

# Oliver

Diseño / Design:  
Sergi Devesa | Óscar Devesa / 2013

Tipología: Plafón  
Typology: Ceiling lamp

Ambiente: Interior  
Environment: Indoor

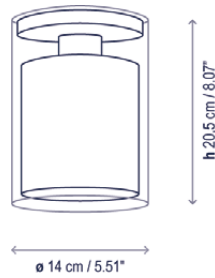

## Descripción técnica / Technical description:

Peso Neto: 1,06 kg  
Net Weight: 1,06 kg

1 Caja/Box | 29 x 29 x 22 cm | 0,0185 m<sup>3</sup>  
Peso bruto / Gross Weight: 1,61 kg

Materiales: Vidrio borosilicato, Hierro  
Materials: Borosilicate glass, Iron

Caja soporte: ø 12,8 cm  
Surface back box: ø 5.04"

Hilo incandescente pantalla / Shade GWF1

Cinta / Ribbon: 960°  
Cotonet Blanco / White Cotton: 800°  
Cotonet Negro / Black Cotton: 960°

Personalizable  
Customizable

Bombillas no incluidas  
Bulbs not included

Certificaciones  
Certifications

Recambios / Spare parts:

R313PLF Cristal Oliver / Oliver Glass

## Descripción lámpara / Lamps description:

230V 50Hz | IP-20 | 1 x 15 W CFL E-27 | 1 x 6 W LED E-27 P45

Ref	Acabados / Finishing	Ean13	Euros
5131306/P734C	Cromo - Pantalla Cinta Translúcida Blanca Chrome - White Translucent Ribbon Shade	8435493713670	257,00
5131306/P735C	Cromo - Pantalla Cinta Translúcida Crema Chrome - Cream Translucent Ribbon Shade	8435493713687	257,00
5131306/P737C	Cromo - Pantalla Cotonet Blanco Chrome - White Cotton Shade	8435493713700	250,00
5131306/P738C	Cromo - Pantalla Cotonet Negro Chrome - Black Cotton Shade	8435493713717	250,00

Familia / Family: Oliver



# Oliver S

Diseño / Design:  
Sergi Devesa | Óscar Devesa / 2013

Tipología: Suspensión  
Typology: Pendant lamp

Ambiente: Interior  
Environment: Indoor

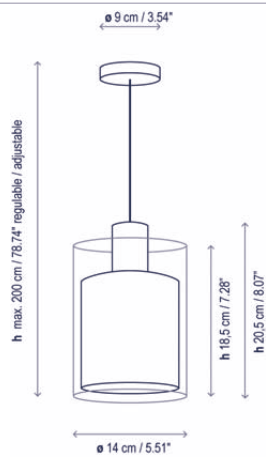

## Descripción técnica / Technical description:

Peso Neto: 1,24 kg  
Net Weight: 1,24 kg

1 Caja/Box | 29 x 29 x 22 cm | 0,0185 m<sup>3</sup>  
Peso bruto / Gross Weight: 1,7 kg

Materiales: Vidrio borosilicato, Hierro  
Materials: Borosilicate glass, Iron

Hilo incandescente pantalla / Shade GWF1

Cinta / Ribbon: 960°  
Cotonet Blanco / White Cotton: 800°  
Cotonet Negro / Black Cotton: 960°

Personalizable  
Customizable

Bombillas no incluidas  
Bulbs not included

Certificaciones  
Certifications

Recambios / Spare parts:

R313SUSP Cristal Oliver / Oliver Glass

## Descripción lámpara / Lamps description:

230V 50Hz | IP-20 | 1 x 15 W CFL E-27 | 1 x 6 W LED E-27 P45

Ref	Acabados / Finishing	Ean13	Euros
4131306/P734C	Cromo - Pantalla Cinta Translúcida Blanca Chrome - White Translucent Ribbon Shade	8435493710860	275,00
4131306/P735C	Cromo - Pantalla Cinta Translúcida Crema Chrome - Cream Translucent Ribbon Shade	8435493710877	275,00
4131306/P737C	Cromo - Pantalla Cotonet Blanco Chrome - White Cotton Shade	8435493710891	262,00
4131306/P738C	Cromo - Pantalla Cotonet Negro Chrome - Black Cotton Shade	8435493710907	262,00

Familia / Family: Oliver



# Oval A/01

Diseño / Design:  
Joana Bover / 2007

Tipología: Aplique  
Typology: Wall lamp

Ambiente: Interior  
Environment: Indoor

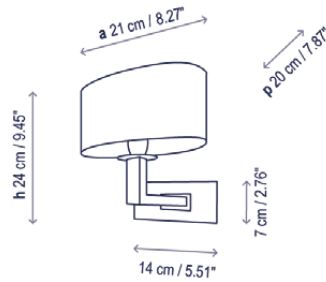

## Descripción técnica / Technical description:

Peso Neto: 0,69 kg  
Net Weight: 0,69 kg

1 Caja/Box | 47 x 47 x 37 cm | 0,0817 m<sup>3</sup>  
Peso bruto / Gross Weight: 2,49 kg

Materiales: Latón, Cristal, Hierro  
Materials: Brass, Glass, Iron

Difusor superior: Cristal negro  
Upper diffuser: Black glass

Caja soporte: 13 x 6 cm  
Surface back box: 5.12" x 2.36"

Hilo incandescente pantalla / Shade GWF1

Cinta / Ribbon: 960°  
Cotonet / Cotton: 800°

Personalizable  
Customizable

Bombillas no incluidas  
Bulbs not included

Certificaciones  
Certifications



## Descripción lámpara / Lamps description:

230V 50Hz | IP-20 | 1 x 46 W EcoClassic P45 E-27 | 1 x 11 W CFL Mini Twist E-27 | 1 x 6 W LED P45 E-27

Ref	Acabados / Finishing	Ean13	Euros
0125006/P600	Cromo - Pantalla Cinta Translúcida Blanca Chrome - White Translucent Ribbon Shade	8435493700144	200,00
0125006/P601	Cromo - Pantalla Cinta Translúcida Crema Chrome - Cream Translucent Ribbon Shade	8435493700151	200,00
0125006/P603	Cromo - Pantalla Cotonet Blanco Chrome - White Cotton Shade	8435493700175	196,00
0125017/P600	Cromo Cristal Negro Pantalla Cinta Translúcida Blanca Chrome Black Glass White Translucent Ribbon Shade	8435493700182	210,00
0125017/P601	Cromo Cristal Negro Pantalla Cinta Translúcida Crema Chrome Black Glass Cream Translucent Ribbon Shade	8435493700199	210,00
0125017/P603	Cromo Cristal Negro Pantalla Cotonet Blanco Chrome Black Glass - White Cotton Shade	8435493700212	196,00
0125005/P600	Níquel Satinado Pantalla Cinta Translúcida Blanca Satin Nickel - White Translucent Ribbon Shade	8435493700106	200,00
0125005/P601	Níquel Satinado Pantalla Cinta Translúcida Crema Satin Nickel - Cream Translucent Ribbon Shade	8435493700113	200,00
0125005/P603	Níquel Satinado Pantalla Cotonet Blanco Satin Nickel - White Cotton Shade	8435493700137	196,00

## Familia / Family: Oval

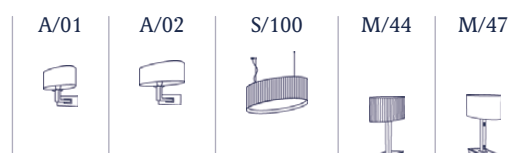

# Oval A/02

Diseño / Design:  
Joana Bover / 2007

Tipología: Aplique  
Typology: Wall lamp

Ambiente: Interior  
Environment: Indoor

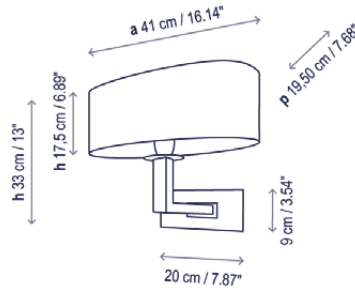

## Descripción técnica / Technical description:

Peso Neto: 1,5 kg  
Net Weight: 1,5 kg

1 Caja/Box | 67 x 67 x 25 cm | 0,1122 m<sup>3</sup>  
Peso bruto / Gross Weight: 5,34 kg

Materiales: Latón, Cristal, Hierro  
Materials: Brass, Glass, Iron

Difusor superior: Cristal negro\*  
Upper diffuser: Black glass\*

La pantalla con difusor solo admite bombillas Eco-Classic y LED.  
Shade with upper diffuser only suitable with Eco-Classic and LED bulbs.

Hilo incandescente pantalla / Shade GWF I

Cinta / Ribbon: 960°  
Cotonet / Cotton: 800°

Caja soporte: 18 x 7 cm  
Surface back box: 7.09" x 2.76"

Personalizable  
Customizable

Bombillas no incluidas  
Bulbs not included

Certificaciones  
Certifications

## Descripción lámpara (sin difusor) / Lamps description (without diffuser):

230V 50HZ | IP-20 | 1 x 46 W EcoClassic P45 E-27 | 1 x 11 W CFL Mini Twist E-27 | 1 x 6 W LED P45 E-27

Ref	Acabados / Finishing	Ean13	Euros
1125006/P551	Cromo - Pantalla Cinta Translúcida Blanca Chrome - White Translucent Ribbon Shade	8435493702483	265,00
1125006/P552	Cromo - Pantalla Cinta Translúcida Crema Chrome - Cream Translucent Ribbon Shade	8435493702506	265,00
1125006/P554	Cromo - Pantalla Cotonet Blanco Chrome - White Cotton Shade	8435493702544	247,00
1125017/P551	Cromo Cristal Negro Pantalla Cinta Translúcida Blanca Chrome Black Glass White Translucent Ribbon Shade	8435493702568	265,00
1125017/P552	Cromo Cristal Negro Pantalla Cinta Translúcida Crema Chrome Black Glass Cream Translucent Ribbon Shade	8435493702582	265,00
1125017/P554	Cromo Cristal Negro Pantalla Cotonet Blanco Chrome Black Glass - White Cotton Shade	8435493702629	247,00
1125005/P551	Níquel Satinado Pantalla Cinta Translúcida Blanca Satin Nickel - White Translucent Ribbon Shade	8435493702407	258,00
1125005/P552	Níquel Satinado Pantalla Cinta Translúcida Crema Satin Nickel - Cream Translucent Ribbon Shade	8435493702421	258,00
1125005/P554	Níquel Satinado Pantalla Cotonet Blanco Satin Nickel - White Cotton Shade	8435493702469	239,00

# Oval A/02

## Descripción lámpara (con difusor) / Lamps description (with diffuser):



Ref	Acabados / Finishing	Ean13	Euros
*1125006/P551D	Cromo - Pantalla Cinta Translúcida Blanca <i>Chrome - White Translucent Ribbon Shade</i>	8435493702490	306,00
*1125006/P552D	Cromo - Pantalla Cinta Translúcida Crema <i>Chrome - Cream Translucent Ribbon Shade</i>	8435493702513	306,00
*1125006/P554D	Cromo - Pantalla Cotonet Blanco <i>Chrome - White Cotton Shade</i>	8435493702551	300,00
*1125017/P551D	Cromo Cristal Negro Pantalla Cinta Translúcida Blanca <i>Chrome Black Glass White Translucent Ribbon Shade</i>	8435493702575	308,00
*1125017/P552D	Cromo Cristal Negro Pantalla Cinta Translúcida Crema <i>Chrome Black Glass Cream Translucent Ribbon Shade</i>	8435493702599	308,00
*1125017/P554D	Cromo Cristal Negro Pantalla Cotonet Blanco <i>Chrome Black Glass - White Cotton Shade</i>	8435493702636	302,00
*1125005/P551D	Níquel Satinado Pantalla Cinta Translúcida Blanca <i>Satin Nickel - White Translucent Ribbon Shade</i>	8435493702414	303,00
*1125005/P552D	Níquel Satinado Pantalla Cinta Translúcida Crema <i>Satin Nickel - Cream Translucent Ribbon Shade</i>	8435493702438	303,00
*1125005/P554D	Níquel Satinado Pantalla Cotonet Blanco <i>Satin Nickel - White Cotton Shade</i>	8435493702476	297,00

## Familia / Family: Oval

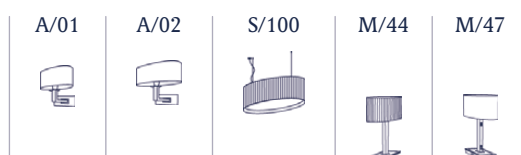



# Oval S/100

Diseño / Design:  
Joana Bover / 2007

Tipología: Suspensión  
Typology: Pendant lamp

Ambiente: Interior  
Environment: Indoor

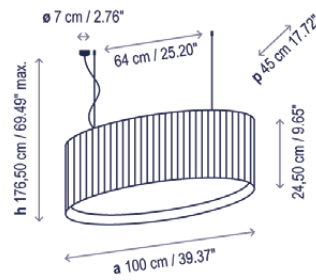

## Descripción técnica / Technical description:

Peso Neto: 2,32 kg  
Net Weight: 2,32 kg

1 Caja/Box | 53 x 103 x 41 cm | 0,2238 m<sup>3</sup>  
Peso bruto / Gross Weight: 5,95 kg

Materiales: Latón, Cristal, Hierro  
Materials: Brass, Glass, Iron

Difusor inferior: PVC 500  
Lower diffuser: PVC 500

El florón independiente del cable tensor proporciona flexibilidad en la instalación.  
Floating canopy allows for flexible installation.

Cable eléctrico transparente. Cables tensores de acero inoxidable.  
Transparent electrical cable. Stainless steel tensor cables.

Hilo incandescente pantalla / Shade GWF1

Cinta / Ribbon: 960°  
Cotonet Blanco / White Cotton: 800°

Hilo incandescente difusor / Diffuser GWF1: 800°

Personalizable  
Customizable

Bombillas no incluidas  
Bulbs not included

Certificaciones  
Certifications

Recambios / Spare parts:

R411301 Tensor 1,5 m / Tensor 1,5 m  
R411303 Tensor 3 m / Tensor 3 m  
R411305 Tensor 5 m / Tensor 5 m  
R199DIF Difusor / Diffuser  
R199 Sujeción difusor / Diffuser hooks  
RSUSP Suspensión / Suspension  
R907001 Manguera 3x0,75 / Cable 3x0,75

## Descripción lámpara / Lamps description:

230V 50Hz IP-20 3 x 46 W EcoClassic P45 E-27 3 x 11 W CFL Mini Twist E-27 3 x 6 W LED P45 E-27

Ref	Acabados / Finishing	Ean13	Euros
4319905/P545C	Níquel Satinado Pantalla Cinta Translúcida Blanca Satin Nickel - White Translucent Ribbon Shade	8435493711874	530,00
4319905/P546C	Níquel Satinado Pantalla Cinta Translúcida Crema Satin Nickel - Cream Translucent Ribbon Shade	8435493711881	530,00
4319905/P548C	Níquel Satinado Pantalla Cotonet Blanco Satin Nickel - White Cotton Shade	8435493711904	395,00

## Familia / Family: Oval

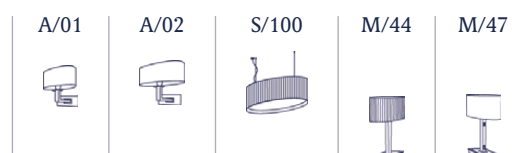

# Oval M/44

Diseño / Design:  
Joana Bover / 2007

Tipología: Mesa  
Typology: Table lamp

Ambiente: Interior  
Environment: Indoor

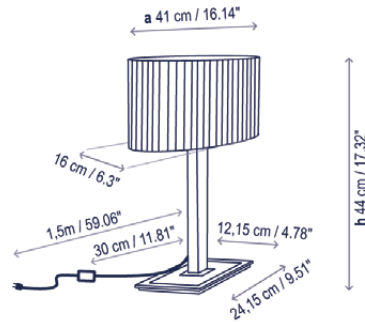

## Descripción técnica / Technical description:

Peso Neto: 2,91 kg  
Net Weight: 2,91 kg

1 Caja/Box | 61 x 61 x 40 cm | 0,1488 m<sup>3</sup>  
Peso bruto / Gross Weight: 5,93 kg

Materiales: Latón, Cristal, Hierro  
Materials: Brass, Glass, Iron

Difusor superior: Cristal negro  
Upper diffuser: Black glass

Cable eléctrico transparente  
Transparent electrical cable

Hilo incandescente pantalla / Shade GWF1

Cinta / Ribbon: 960°  
Cotonet / Cotton: 800°

Personalizable  
Customizable

Bombillas no incluidas  
Bulbs not included

Certificaciones  
Certifications

Recambios / Spare parts:

R21250D Difusor cristal / Diffuser glass  
R21250B Base cristal / Base glass

## Descripción lámpara / Lamps description:

230V 50Hz | IP-20 | 1 x 46 W EcoClassic P45 E-27 | 1 x 6 W LED E-27 P45

Ref	Acabados / Finishing	Ean13	Euros
2125023/P551D	Cromo Cristal Negro Pantalla Cinta Translúcida Blanca Chrome Black Glass White Translucent Ribbon Shade	8435493704654	370,00
2125023/P552D	Cromo Cristal Negro Pantalla Cinta Translúcida Crema Chrome Black Glass Cream Translucent Ribbon Shade	8435493704661	370,00
2125023/P554D	Cromo Cristal Negro Pantalla Cotonet Blanco Chrome Black Glass - White Cotton Shade	8435493704685	365,00
2125017/P551D	Níquel Cristal Negro Pantalla Cinta Translúcida Blanca Nickel Black Glass - White Translucent Ribbon Shade	8435493704579	370,00
2125017/P552D	Níquel Cristal Negro Pantalla Cinta Translúcida Crema Nickel Black Glass - Cream Translucent Ribbon Shade	8435493704586	370,00
2125017/P554D	Níquel Cristal Negro Pantalla Cotonet Blanco Nickel Black Glass - White Cotton Shade	8435493704609	365,00

## Familia / Family: Oval

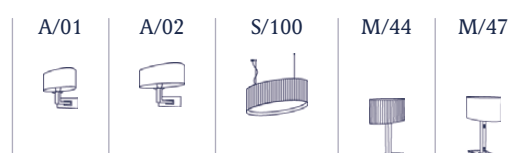

# Oval M/47

Diseño / Design:  
Joana Bover / 2007

Tipología: Mesa  
Typology: Table lamp

Ambiente: Interior  
Environment: Indoor

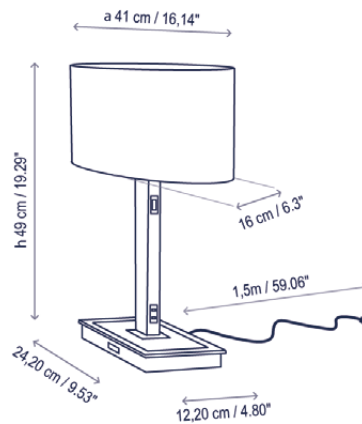

## Descripción técnica / Technical description:

Peso Neto: 2,52 kg  
Net Weight: 2,52 kg

1 Caja/Box | 67 x 67 x 25 cm | 0,1122 m<sup>3</sup>  
Peso bruto / Gross Weight: 5,62 kg

Materiales: Latón, Cristal, Hierro  
Materials: Brass, Glass, Iron

Difusor superior: Cristal negro  
Upper diffuser: Black glass

Cable eléctrico transparente  
Transparent electrical cable



Interruptor de encendido y enchufe para clavija tipo C situado en mástil.  
Entrada conector USB en la base.  
On/Off switch and outlet for type C plug located on the stem.  
USB port located on the base.

Hilo incandescente pantalla / Shade GWF1

Cinta / Ribbon: 960°  
Cotonet / Cotton: 800°

USB: 5V 1A

Personalizable  
Customizable

Bombillas no incluidas  
Bulbs not included

Certificaciones  
Certifications

Recambios / Spare parts:

R21250D Difusor cristal / Diffuser glass  
R21250B Base cristal / Base glass

## Descripción lámpara / Lamps description:

230V 50Hz IP-20 1 x 46 W EcoClassic P45 E-27 1 x 6 W LED E-27 P45

Ref	Acabados / Finishing	Ean13	Euros
2125023USB/P551D	Cromo Cristal Negro Pantalla Cinta Translúcida Blanca Chrome Black Glass White Translucent Ribbon Shade	8435493704692	493,00
2125023USB/P552D	Cromo Cristal Negro Pantalla Cinta Translúcida Crema Chrome Black Glass Cream Translucent Ribbon Shade	8435493704708	493,00
2125023USB/P554D	Cromo Cristal Negro Pantalla Cotonet Blanco Chrome Black Glass - White Cotton Shade	8435493704722	488,00
2125017USB/P551D	Níquel Cristal Negro Pantalla Cinta Translúcida Blanca Nickel Black Glass - White Translucent Ribbon Shade	8435493704616	493,00
2125017USB/P552D	Níquel Cristal Negro Pantalla Cinta Translúcida Crema Nickel Black Glass - Cream Translucent Ribbon Shade	8435493704623	493,00
2125017USB/P554D	Níquel Cristal Negro Pantalla Cotonet Blanco Nickel Black Glass - White Cotton Shade	8435493704647	488,00

## Familia / Family: Oval

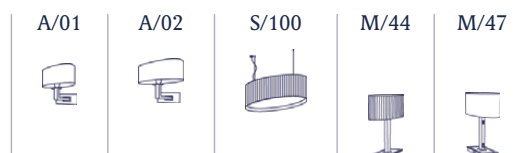

# Penta S/30

## Diseño / Design:

Juan Carlos Ines Bertolín | Gonzalo Milà / 2017

## Tipología: Suspensión

Typology: Pendant Lamp

## Ambiente: Interior

Environment: Indoor



## Descripción técnica / Technical description:

**Peso Neto: 1,55 kg**  
Net Weight: 1,55 kg

**1 Caja/Box | 38 x 38 x 41 cm | 0,0592 m<sup>3</sup>**  
Peso bruto / Gross Weight: 3,24 kg

**Materiales: Aluminio, Latón, Hierro**  
Materials: Aluminum, Brass, Iron

**Difusor: Metacrilato**  
Diffuser: Methacrylate

**Sistema de fabricación mediante estampación de metal.**  
Shade made of stamped metal.

**Sistema de regulación mediante varilla táctil flexible.**  
Dimming system by a flexible touch-sensitive lower bar.

**Consultar opción dimable TRIAC (sin varilla táctil de regulación).**  
Consult TRIAC dimable option (without flexible touch-sensitive lower bar).

**Cable coaxial negro (acabado latón envejecido o cobre antiguo).**  
Cable coaxial blanco (acabado blanco roto).  
Black coaxial cable (antique brass or antique copper finish).  
White coaxial cable (natural white finish).

**Personalizable: acabado**  
Customizable: finishing

**Certificaciones**  
Certifications

## Recambios / Spare parts:

R906019N Cable coaxial negro  
Black coaxial cable

R906014B Cable coaxial blanco  
White coaxial cable

## Descripción lámpara / Lamps description:

230V 50Hz | IP-20 | 8,4 W LED / CRI: 90 / 2700°K | 902 lm fuente de luz / light source

Ref	Acabados / Finishing	Ean13	Euros
3550121883	Latón Envejecido Interior Pantalla Latón Pulido Antique Brass Shade: Polished Brass Inside	8436544896328	630,00
3550121884	Cobre Antiguo Interior Pantalla Cobre Pulido Antique Copper Shade: Polished Copper Inside	8436544896342	651,00
35501218246	Blanco Roto Interior Pantalla Acabado Cobre Natural White Shade: Copper Finish Inside	8435493723600	529,00

# Plafonet 43

Diseño / Design:  
Joana Bover / 2005

Tipología: Plafón  
Typology: Ceiling lamp

Ambiente: Interior  
Environment: Indoor

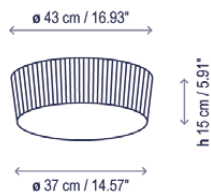

## Descripción técnica / Technical description:

Peso Neto: 2,57 kg  
Net Weight: 2,57 kg

1 Caja/Box | 47 x 47 x 37 cm | 0,0817 m<sup>3</sup>  
Peso bruto / Gross Weight: 4,24 kg

Materiales: Hierro, Latón  
Materials: Iron, Brass

Difusor: Metacrilato  
Diffuser: Methacrylate

Caja soporte: ø 38 cm  
Surface back box: ø 14.96"

Hilo incandescente pantalla / Shade GWF1

Cinta / Ribbon: 960°  
Cotonet / Cotton: 800°

Personalizable  
Customizable

Bombillas no incluidas  
Bulbs not included

Certificaciones  
Certifications

Recambios / Spare parts:

R01249 Cristal óptico / Optical Glass

## Descripción lámpara / Lamps description:

230V 50Hz | IP-20 | 2 x 46 W EcoClassic P45 E-27 | 2 x 14 W CFL E-27 | 2 x 6 W LED P45 E-27

Ref	Acabados / Finishing	Ean13	Euros
0124905B	Cromo - Pantalla Cinta Translúcida Blanca Chrome - White Translucent Ribbon Shade	8436047304313	278,00
0124905C	Cromo - Pantalla Cinta Translúcida Crema Chrome - Cream Translucent Ribbon Shade	8436047304290	278,00
0124905T	Cromo - Pantalla Cotonet Blanco Chrome - White Cotton Shade	8436047304337	235,00

Familia / Family: Plafonet

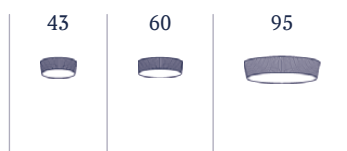

# Plafonet 60

Diseño / Design:  
Joana Bover / 2005

Tipología: Plafón  
Typology: Ceiling lamp

Ambiente: Interior  
Environment: Indoor

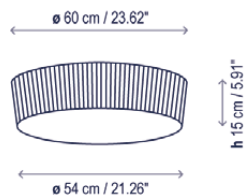

## Descripción técnica / Technical description:

Peso Neto: 4,44 kg  
Net Weight: 4,44 kg

1 Caja/Box | 61 x 61 x 40 cm | 0,1488 m<sup>3</sup>  
Peso bruto / Gross Weight: 6,81 kg

Materiales: Hierro, Latón  
Materials: Iron, Brass

Difusor: Metacrilato  
Diffuser: Methacrylate

Caja soporte: ø 43 cm  
Surface back box: ø 16.93"

Hilo incandescente pantalla / Shade GWF I

Cinta / Ribbon: 960°  
Cotonet / Cotton: 800°

Personalizable  
Customizable

Bombillas no incluidas  
Bulbs not included

Certificaciones  
Certifications

Recambios / Spare parts:

R02249 Cristal óptico / Optical Glass

## Descripción lámpara / Lamps description:

230V 50Hz | IP-20 | 4 x 46 W EcoClassic P45 E-27 | 4 x 14 W CFL E-27 | 4 x 6 W LED P45 E-27

Ref	Acabados / Finishing	Ean13	Euros
0224905B	Cromo - Pantalla Cinta Translúcida Blanca Chrome - White Translucent Ribbon Shade	8436047304382	420,00
0224905C	Cromo - Pantalla Cinta Translúcida Crema Chrome - Cream Translucent Ribbon Shade	8436047304368	420,00
0224905T	Cromo - Pantalla Cotonet Blanco Chrome - White Cotton Shade	8436047304405	332,00

Familia / Family: Plafonet

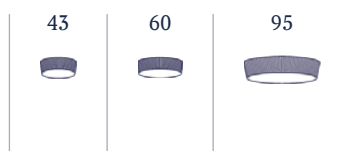



# Plafonet 95

Diseño / Design:  
Joana Bover / 2005

Tipología: Plafón  
Typology: Ceiling lamp

Ambiente: Interior  
Environment: Indoor

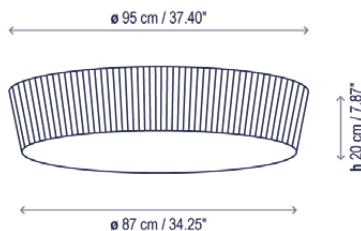

## Descripción técnica / Technical description:

Peso Neto: 12,46 kg  
Net Weight: 12,46 kg

1 Caja/Box | 96 x 96 x 45 cm | 0,4147 m<sup>3</sup>  
Peso bruto / Gross Weight: 17,43 kg

Materiales: Hierro, Latón  
Materials: Iron, Brass

Difusor: Metacrilato  
Diffuser: Methacrylate

Caja soporte: ø 83 cm  
Surface back box: ø 32.68"

Hilo incandescente pantalla / Shade GWF I

Cinta / Ribbon: 960°  
Cotonet / Cotton: 800°

Personalizable  
Customizable

Bombillas no incluidas  
Bulbs not included

Certificaciones  
Certifications

Recambios / Spare parts:

R03249 Difusor / Diffuser

## Descripción lámpara / Lamps description:

230V 50HZ | IP-20 | 6 x 22 W CFL E-27 | 6 x 9 W LED P45 E-27

Ref	Acabados / Finishing	Ean13	Euros
0324905B	Cromo - Pantalla Cinta Translúcida Blanca Chrome - White Translucent Ribbon Shade	8436047308595	738,00
0324905C	Cromo - Pantalla Cinta Translúcida Crema Chrome - Cream Translucent Ribbon Shade	8436047308571	738,00
0324905T	Cromo - Pantalla Cotonet Blanco Chrome - White Cotton Shade	8436047308618	694,00

Familia / Family: Plafonet

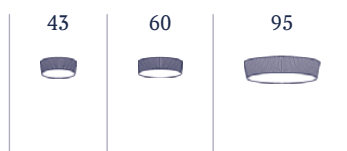

# Siam 80

Diseño / Design:  
Joana Bover / 2010

Tipología: Plafón  
Typology: Ceiling lamp

Ambiente: Interior  
Environment: Indoor

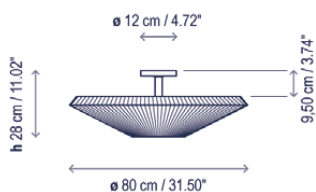

## Descripción técnica / Technical description:

Peso Neto: 2,97 kg  
Net Weight: 2,97 kg

1 Caja/Box | 91 x 92 x 26 cm | 0,2177 m<sup>3</sup>  
Peso bruto / Gross Weight: 6,46 kg

Materiales: Hierro, Acero Inoxidable  
Materials: Iron, Stainless steel

Difusor inferior: Metacrilato  
Lower diffuser: Methacrylate

Hilo incandescente pantalla: 960°  
Shade GWF1: 960°

Personalizable  
Customizable

Bombillas no incluidas  
Bulbs not included

Certificaciones  
Certifications

Recambios / Spare parts:

R01320DIF Difusor / Diffuser

## Descripción lámpara / Lamps description:

230V 50Hz IP-20 3 x 22 W CFL E-27 3 x 6 W LED E-27 P45

Ref	Acabados / Finishing	Ean13	Euros
0132005/P686C	Estructura Níquel Satinado Pantalla Cinta Translúcida Blanca Satin Nickel Structure White Translucent Ribbon Shade	8435493700335	541,00
0132005/P687C	Estructura Níquel Satinado Pantalla Cinta Translúcida Crema Satin Nickel Structure Cream Translucent Ribbon Shade	8435493700342	541,00

Familia / Family: Siam

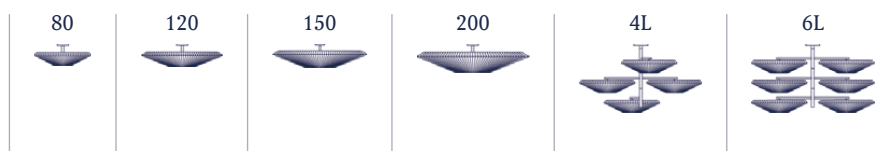

# Siam 120

Diseño / Design:  
Joana Bover / 2010

Tipología: Plafón  
Typology: Ceiling lamp

Ambiente: Interior  
Environment: Indoor

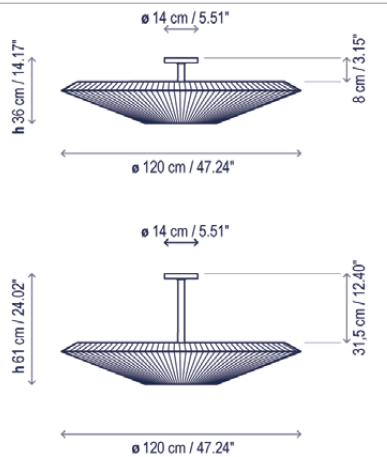

## Descripción técnica / Technical description:

Peso Neto (estructura pequeña): 8,11 kg  
Net Weight (small structure): 8,11 kg

Peso Neto (estructura grande): 8,27 kg  
Net Weight (big structure): 8,27 kg

### Opcional/ Optional:

1 Caja/Box | 127 x 128 x 45 cm | 0,7315 m<sup>3</sup>  
Peso bruto / Gross Weight: 14,83 kg

1 Caja Madera/Wood Box  
133 x 45 x 155 cm | 0,9277 m<sup>3</sup>  
Peso bruto / Gross Weight: 50,27 kg

Materiales: Hierro, Acero Inoxidable  
Materials: Iron, Stainless steel

Difusor inferior: Metacrilato  
Lower diffuser: Methacrylate

Las dos estructuras permiten crear múltiples composiciones mediante la superposición de las pantallas.  
The 2 structure sizes allows for several group compositions by partially superimposing shades.

Hilo incandescente pantalla: 960°  
Shade GWFI: 960°

Personalizable  
Customizable

Bombillas no incluidas  
Bulbs not included

Certificaciones  
Certifications

Recambios / Spare parts:

R02320DIF Difusor / Diffuser

## Descripción lámpara (Estructura Pequeña) / Lamps description (Small Structure):

230V 50Hz | IP-20 | 6 x 46 W EcoClassic P45 E-27 | 6 x 30 W CFL E-27 | 6 x 9 W LED A60 E-27 |

Ref	Acabados / Finishing	Ean13	Euros
0232005P/P698C	Níquel - Pantalla Cinta Translúcida Blanca Nickel - White Translucent Ribbon Shade	8435493700595	1.462,00
0232005P/P699C	Níquel - Pantalla Cinta Translúcida Crema Nickel - Cream Translucent Ribbon Shade	8435493700601	1.462,00

## Descripción lámpara (Estructura Grande) / Lamps description (Big Structure):

230V 50Hz | IP-20 | 6 x 46 W EcoClassic P45 E-27 | 6 x 30 W CFL E-27 | 6 x 9 W LED A60 E-27 |

Ref	Acabados / Finishing	Ean13	Euros
0232005G/P698C	Níquel - Pantalla Cinta Translúcida Blanca Nickel - White Translucent Ribbon Shade	8435493700564	1.464,00
0232005G/P699C	Níquel - Pantalla Cinta Translúcida Crema Nickel - Cream Translucent Ribbon Shade	8435493700571	1.464,00

## Familia / Family: Siam

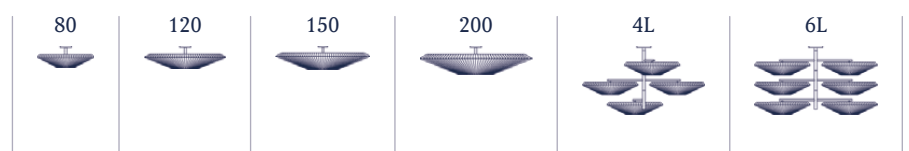

# Siam 150

Diseño / Design:  
Joana Bover / 2010

Tipología: Plafón  
Typology: Ceiling lamp

Ambiente: Interior  
Environment: Indoor

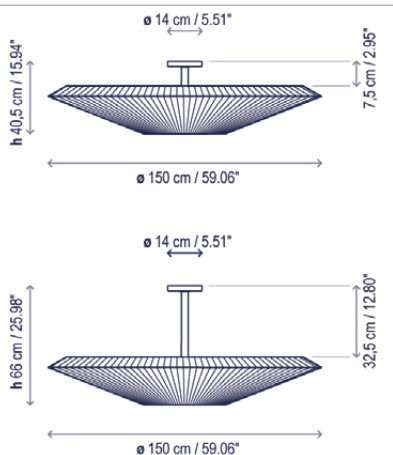

## Descripción técnica / Technical description:

Peso Neto (estructura pequeña): 11,24 kg  
Net Weight (small structure): 11,24 kg

Peso Neto (estructura grande): 11,4 kg  
Net Weight (big structure): 11,4 kg

### Opcional/ Optional:

1 Caja/Box | 157 x 157 x 77 cm | 1,898 m<sup>3</sup>  
Peso bruto / Gross Weight: 18,65 kg

1 Caja Madera/Wood Box  
163 x 55 x 175 cm | 1,5689 m<sup>3</sup>  
Peso bruto / Gross Weight: 61,40 kg

Materiales: Hierro, Acero Inoxidable  
Materials: Iron, Stainless steel

Difusor inferior: Policarbonato  
Lower diffuser: Polycarbonate

Las dos estructuras permiten crear múltiples composiciones mediante la superposición de las pantallas.  
The 2 structure sizes allows for several group compositions by partially superimposing shades.

Hilo incandescente pantalla: 960°  
Shade GWFI: 960°

Personalizable  
Customizable

Bombillas no incluidas  
Bulbs not included

Certificaciones  
Certifications

Recambios / Spare parts:

R05320DIF Difusor / Diffuser

## Descripción lámpara (Estructura Pequeña) / Lamps description (Small Structure):



Ref	Acabados / Finishing	Ean13	Euros
0232005P/P773C	Níquel - Pantalla Cinta Translúcida Blanca Nickel - White Translucent Ribbon Shade	8435493722825	1.745,00
0232005P/P774C	Níquel - Pantalla Cinta Translúcida Crema Nickel - Cream Translucent Ribbon Shade	8435493722634	1.745,00

## Descripción lámpara (Estructura Grande) / Lamps description (Big Structure):



Ref	Acabados / Finishing	Ean13	Euros
0232005G/P773C	Níquel - Pantalla Cinta Translúcida Blanca Nickel - White Translucent Ribbon Shade	8435493722597	1.752,00
0232005G/P774C	Níquel - Pantalla Cinta Translúcida Crema Nickel - Cream Translucent Ribbon Shade	8436544890418	1.752,00

## Familia / Family: Siam

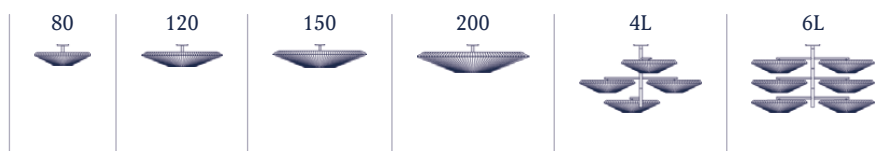

# Siam 200

Diseño / Design:  
Joana Bover / 2010

Tipología: Plafón  
Typology: Ceiling lamp

Ambiente: Interior  
Environment: Indoor

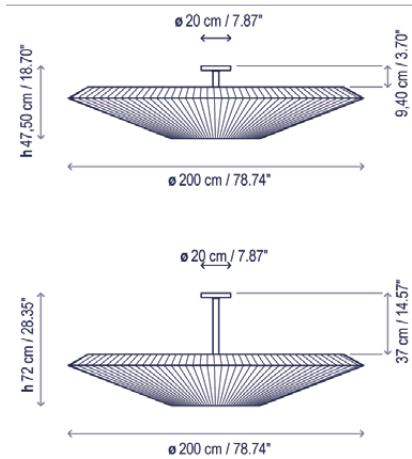

## Descripción técnica / Technical description:

Peso Neto: 20 kg  
Net Weight: 20 kg

2 Cajas / 2 Boxes:

1 Caja/Box | 210 x 210 x 57 cm | 2,5137 m<sup>3</sup>  
Peso bruto / Gross Weight: 35 kg

1 Caja/Box | 215 x 55 x 220 cm | 2,6015 m<sup>3</sup>  
Peso bruto / Gross Weight: 95 kg

Materiales: Hierro, Acero Inoxidable  
Materials: Iron, Stainless steel

Difusor inferior: Metacrilato  
Lower diffuser: Methacrylate

Las dos estructuras permiten crear múltiples composiciones mediante la superposición de las pantallas.  
The 2 structure sizes allows for several group compositions by partially superimposing shades.

Hilo incandescente pantalla: 960°  
Shade GWF: 960°

Personalizable  
Customizable

Bombillas no incluidas  
Bulbs not included

Certificaciones  
Certifications

Recambios / Spare parts:

R03320DIF Difusor / Diffuser

## Descripción lámpara (Estructura Pequeña) / Lamps description (Small Structure):



Ref	Acabados / Finishing	Ean13	Euros
0332005P/P690C	Níquel - Pantalla Cinta Translúcida Blanca Nickel - White Translucent Ribbon Shade	8435493700854	2.992,00
0332005P/P691C	Níquel - Pantalla Cinta Translúcida Crema Nickel - Cream Translucent Ribbon Shade	8435493700861	2.992,00

## Descripción lámpara (Estructura Grande) / Lamps description (Big Structure):



Ref	Acabados / Finishing	Ean13	Euros
0332005G/P690C	Níquel - Pantalla Cinta Translúcida Blanca Nickel - White Translucent Ribbon Shade	8435493700823	3.070,00
0332005G/P691C	Níquel - Pantalla Cinta Translúcida Crema Nickel - Cream Translucent Ribbon Shade	8435493700830	3.070,00

## Familia / Family: Siam

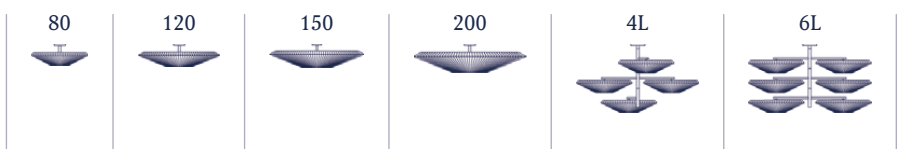

# Siam 4L

Diseño / Design:  
Joana Bover / 2010

Tipología: Suspensión  
Typology: Pendant lamp

Ambiente: Interior  
Environment: Indoor

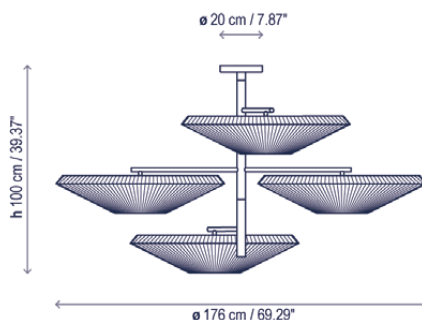

## Descripción técnica / Technical description:

Peso Neto: 9,89 kg  
Net Weight: 9,89 kg

1 Caja/Box | 97 x 106 x 130 cm | 1,3367 m<sup>3</sup>  
Peso bruto / Gross Weight: 23,38 kg

Materiales: Hierro, Acero Inoxidable  
Materials: Iron, Stainless steel

Difusor inferior: Metacrilato  
Lower diffuser: Methacrylate

Los brazos horizontales se pueden mover y fijar en la posición deseada.  
Horizontal arms can be adjusted into the desired position and then locked to prevent movement.

Hilo incandescente pantalla: 960°  
Shade GWFI: 960°

Personalizable  
Customizable

Bombillas no incluidas  
Bulbs not included

Certificaciones  
Certifications

Recambios / Spare parts:

R01320DIF Difusor / Diffuser

## Descripción lámpara / Lamps description:



Ref	Acabados / Finishing	Ean13	Euros
4432005/P686C	Níquel Satinado Pantalla Cinta Translúcida Blanca Satin Nickel - White Translucent Ribbon Shade	8435493712567	2.480,00
4432005/P687C	Níquel Satinado Pantalla Cinta Translúcida Crema Satin Nickel - Cream Translucent Ribbon Shade	8435493712574	2.480,00

## Familia / Family: Siam

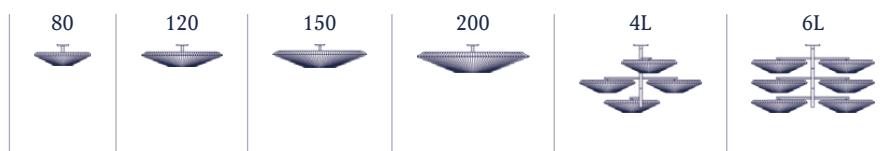



# Siam 6L

Diseño / Design:  
Joana Bover / 2010

Tipología: Suspensión  
Typology: Pendant lamp

Ambiente: Interior  
Environment: Indoor

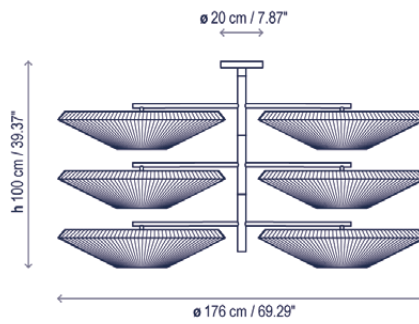

## Descripción técnica / Technical description:

Peso Neto: 10,59 kg  
Net Weight: 10,59 kg

1 Caja/Box | 97 x 106 x 130 cm | 1,3367 m<sup>3</sup>  
Peso bruto / Gross Weight: 26,08 kg

Materiales: Hierro, Acero Inoxidable  
Materials: Iron, Stainless steel

Difusor inferior: Metacrilato  
Lower diffuser: Methacrylate

Los brazos horizontales se pueden mover y fijar en la posición deseada.  
Horizontal arms can be adjusted into the desired position and then locked to prevent movement.

Hilo incandescente pantalla: 960°  
Shade GWFI: 960°

Personalizable  
Customizable

Bombillas no incluidas  
Bulbs not included

Certificaciones  
Certifications

Recambios / Spare parts:

R01320DIF Difusor / Diffuser

## Descripción lámpara / Lamps description:



Ref	Acabados / Finishing	Ean13	Euros
4632005/P686C	Níquel Satinado Pantalla Cinta Translúcida Blanca Satin Nickel - White Translucent Ribbon Shade	8435493713083	3.425,00
4632005/P687C	Níquel Satinado Pantalla Cinta Translúcida Crema Satin Nickel - Cream Translucent Ribbon Shade	8435493713090	3.425,00

## Familia / Family: Siam

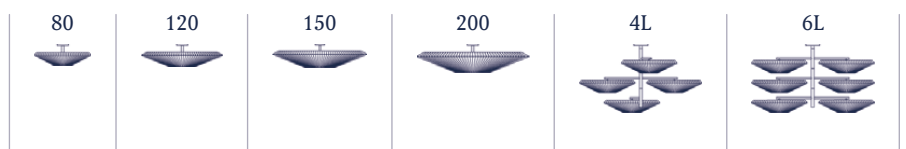

# Sisal A/01 Outdoor

Diseño / Design:  
Joana Bover / 2019

Tipología: Aplique  
Typology: Wall lamp

Ambiente: Exterior  
Environment: Outdoor

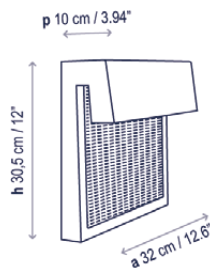

## Descripción técnica / Technical description:

Peso Neto: 2,64 kg  
Net Weight: 2,64 kg

1 Caja/Box | 43 x 12 x 45 cm | 0,0232 m<sup>3</sup>  
Peso bruto / Gross Weight: 2,96 kg

Materiales: Aluminio, Policarbonato, Acero Inoxidable, Fibra Sintética.  
Materials: Aluminum, Polycarbonate, Stainless steel, Synthetic fiber.

Estructuras de metal acabadas con cataforesis y pintura de poliéster epoxi.  
Metal surfaces coated with cataphoresis and epoxy polyester paint.

Fuente de luz protegida por difusor de policarbonato.  
Light source protected by polycarbonate diffuser.

\*Pantallas tejidas a mano con fibra de polietileno sintética reciclable y no tóxica.  
\*Hand woven with a recyclable and non-toxic synthetic polyethylene fiber.

Nota de uso: Para ambientes con alto grado de salinidad, será necesario realizar un correcto mantenimiento de la luminaria. Recomendamos limpiar con un cepillo suave y retirar la sal, el polvo, o la suciedad depositada por la humedad o el viento.  
Note of use: For environments with a high salinity, proper maintenance of the luminaire will be necessary. We recommend cleaning it with a soft brush and remove salt, dust, or dirt deposited by moisture or wind.

Consulte la tabla de reguladores TRIAC recomendados en la página 212.  
Please check the list of recommended TRIAC dimmers at page 212.

Caja soporte: 32 x 30 cm  
Surface back box: 12.6" x 11.81"

Personalizable: acabado  
Customizable: finishing

Certificaciones  
Certifications

## Descripción lámpara / Lamps description:

230V 50Hz | IP-66 | 9,1 W LED / CRI: 90 / 2700°K | 990 lm fuente de luz / light source

Ref	Acabados / Finishing	Ean13	Euros
28401012118	Regulable Triac - Marrón Frontal Fibra Marrón* Dimmable Triac - Brown Frontal Brown Fiber*	8435493724652	310,00
28401012117	Regulable Triac - Marrón Frontal Fibra Beige Claro* Dimmable Triac - Brown Frontal Light Beige Fiber*	8435493724027	310,00

\*Por favor, tenga en cuenta que los tonos de color del frontal de fibra pueden no ser los mismos en todos los casos. / Please note that the fiber frontal may have small variations in tone.

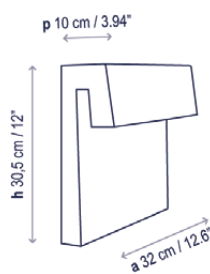

## Descripción lámpara / Lamps description:

230V 50Hz | IP-66 | 9,1 W LED / CRI: 90 / 2700°K | 990 lm fuente de luz / light source

Ref	Acabados / Finishing	Ean13	Euros
28402012014	Regulable Triac - Metal Marrón Dimmable Triac - Brown Metal	8435493725338	270,00

# Skybell Catenary

Diseño / Design:  
Estudi Manel Molina / 2019

Tipología: Suspensión  
Typology: Pendant lamp

Ambiente: Interior  
Environment: Indoor

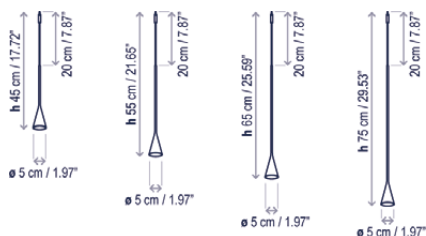

## S/5L/10

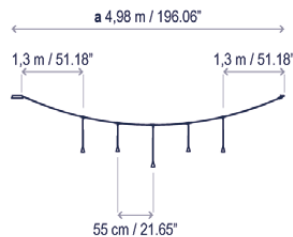

Luces / Lights  
1 x 65 cm / 25.59"  
2 x 55 cm / 21.65"  
2 x 45 cm / 17.72"



### Descripción técnica / Technical description:

Peso Neto: 1,43 kg  
Net Weight: 1,43 kg

1 Caja/Box | 56 x 57 x 24 cm | 0,0766 m³  
Peso bruto / Gross Weight: 3,44 kg

Materiales: Hierro, Aluminio  
Materials: Iron, Aluminum

Acabado estructura: color ébano negro  
Structure finish: ebony black

Óptica 30° apertura estándar  
Beam angle 30° standard

Opciones bajo pedido:  
· 3000K  
· Óptica 40°

Options upon request:  
· 3000K  
· Beam angle 40°

Personalizable  
Customizable

Certificaciones  
Certifications

Fijación a techo o pared  
Anchoring to ceiling or wall

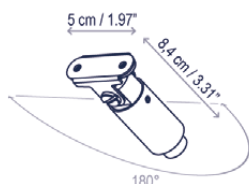

Florón a techo  
Floor Canopy

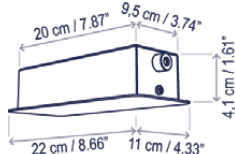

### Descripción lámpara / Lamps description:

230V 50Hz IP-20 0/1-10V / DALI / PUSH 14 W LED / CRI: 90 / 2700°K 1860 lm fuente de luz / light source

Ref	Acabados / Finishing	Ean13	Euros
35702219056	Regulable 0/1-10v/Dali/Push Bell 45/55/65 cm Dimmable 0/1-10v/Dali/Push Bell 45/55/65 cm	8435493724706	841,00

## S/5L/11

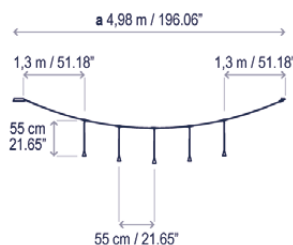

Luces / Lights  
5 x 55 cm / 21.65"

⊗ Aconsejamos no cortar o manipular el cable por ninguno de los extremos, ello puede conllevar una incorrecta posición de las luminarias Skybell. Debido al peso y la tensión que ejerce la catenaria, aconsejamos no utilizarla en techos modulares de fibra, placas de escayola de 10 mm o lamas metálicas sin reforzar el punto de anclaje mediante una estructura autoportante.

We advise to neither cut nor manipulate the cable at either end as this may lead to an incorrect position of the Skybell luminaires. Due to the weight and tension exerted by the catenary, we advise against using it on tile ceilings, 10 mm plasterboard or metal slats without reinforcing the anchor point by means of a self-supporting structure.

### Descripción lámpara / Lamps description:

230V 50Hz IP-20 0/1-10V / DALI / PUSH 14 W LED / CRI: 90 / 2700°K 1860 lm fuente de luz / light source

Ref	Acabados / Finishing	Ean13	Euros
35706219056	Regulable 0/1-10v/Dali/Push - Bell 55 cm Dimmable 0/1-10v/Dali/Push - Bell 55 cm	8435493724799	841,00

### Familia / Family: Skybell Catenary

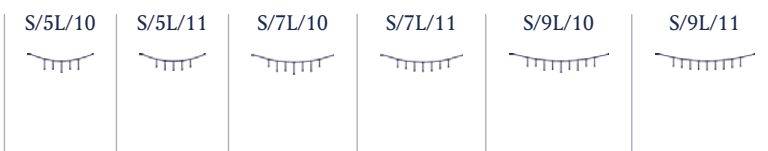

# Skybell Catenary

Diseño / Design:  
Estudi Manel Molina / 2019

Tipología: Suspensión  
Typology: Pendant lamp

Ambiente: Interior  
Environment: Indoor

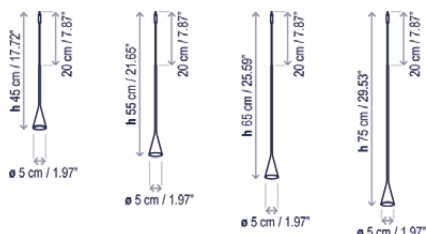

## S/7L/10

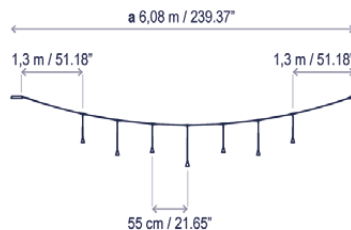

Luces / Lights  
1 x 65 cm / 25.59"  
2 x 55 cm / 21.65"  
4 x 45 cm / 17.72"



### Descripción técnica / Technical description:

Peso Neto: 1,9 kg  
Net Weight: 1,9 kg

1 Caja/Box | 56 x 57 x 24 cm | 0,0766 m³  
Peso bruto / Gross Weight: 3,91 kg

Materiales: Hierro, Aluminio  
Materials: Iron, Aluminum

Acabado estructura: color ébano negro  
Structure finish: ebony black

Óptica 30° apertura estándar  
Beam angle 30° standard

Opciones bajo pedido:  
· 3000K  
· Óptica 40°

Options upon request:  
· 3000K  
· Beam angle 40°

Personalizable  
Customizable

Certificaciones  
Certifications

Fijación a techo o pared  
Anchoring to ceiling or wall

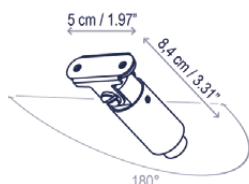

Florón a techo  
Floor Canopy

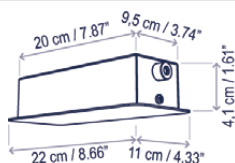

### Descripción lámpara / Lamps description:

230V 50Hz IP-20 DALI / PUSH 19,6 W LED / CRI: 90 / 2700°K | 2604 lm fuente de luz / light source

Ref	Acabados / Finishing	Ean13	Euros
35703219056	Regulable 0/1-10v/Dali/Push Bell 45/55/65 cm Dimmable 0/1-10v/Dali/Push Bell 45/55/65 cm	8435493724720	1.051,00

## S/7L/11

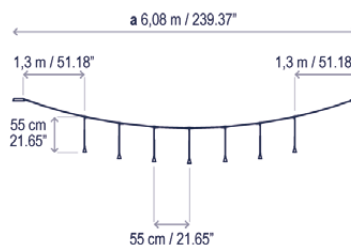

Luces / Lights  
7 x 55 cm / 21.65"

Aconsejamos no cortar o manipular el cable por ninguno de los extremos, ello puede conllevar una incorrecta posición de las luminarias Skybell. Debido al peso y la tensión que ejerce la catenaria, aconsejamos no utilizarla en techos modulares de fibra, placas de escayola de 10 mm o lamas metálicas sin reforzar el punto de anclaje mediante una estructura autoportante.

We advise to neither cut nor manipulate the cable at either end as this may lead to an incorrect position of the Skybell luminaires. Due to the weight and tension exerted by the catenary, we advise against using it on tile ceilings, 10 mm plasterboard or metal slats without reinforcing the anchor point by means of a self-supporting structure.

### Descripción lámpara / Lamps description:

230V 50Hz IP-20 DALI / PUSH 19,6 W LED / CRI: 90 / 2700°K | 2604 lm fuente de luz / light source

Ref	Acabados / Finishing	Ean13	Euros
35707219056	Regulable 0/1-10v/Dali/Push - Bell 55 cm Dimmable 0/1-10v/Dali/Push - Bell 55 cm	8435493724805	1.051,00

### Familia / Family: Skybell Catenary

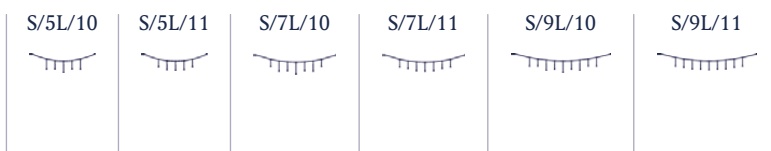



# Skybell Catenary

Diseño / Design:  
Estudi Manel Molina / 2019

Tipología: Suspensión  
Typology: Pendant lamp

Ambiente: Interior  
Environment: Indoor

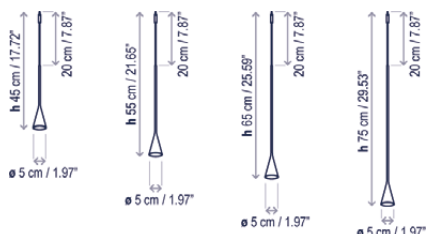

## S/9L/10

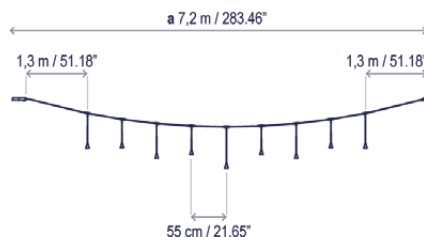

Luces / Lights  
1 x 65 cm / 25.59"  
4 x 55 cm / 21.65"  
4 x 45 cm / 17.72"



### Descripción técnica / Technical description:

Peso Neto: 2,43 kg  
Net Weight: 2,43 kg

1 Caja/Box | 67 x 67 x 25 cm | 0,1122 m<sup>3</sup>  
Peso bruto / Gross Weight: 5,44 kg

Materiales: Hierro, Aluminio  
Materials: Iron, Aluminum

Acabado estructura: color ébano negro  
Structure finish: ebony black

Óptica 30° apertura estándar  
Beam angle 30° standard

Opciones bajo pedido:  
· 3000K  
· Óptica 40°

Options upon request:  
· 3000K  
· Beam angle 40°

Personalizable  
Customizable

Certificaciones  
Certifications

Fijación a techo o pared  
Anchoring to ceiling or wall

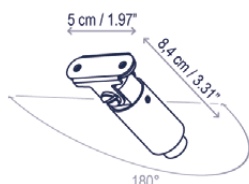

Florón a techo  
Floor Canopy

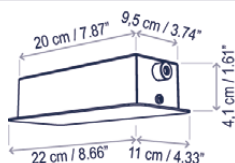

### Descripción lámpara / Lamps description:

230V 50Hz | IP-20 | 25.2 W LED / CRI: 90 / 2700°K | 3348 lm fuente de luz / light source

Ref	Acabados / Finishing	Ean13	Euros
35704219056	Regulable 0/1-10v/Dali/Push Bell 45/55/65 cm Dimmable 0/1-10v/Dali/Push Bell 45/55/65 cm	8435493724768	1.287,00

## S/9L/11

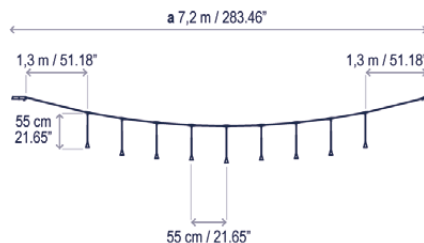

Luces / Lights  
9 x 55 cm / 21.65"

⊗ Aconsejamos no cortar o manipular el cable por ninguno de los extremos, ello puede conllevar una incorrecta posición de las luminarias Skybell. Debido al peso y la tensión que ejerce la catenaria, aconsejamos no utilizarla en techos modulares de fibra, placas de escayola de 10 mm o lamas metálicas sin reforzar el punto de anclaje mediante una estructura autoportante.

We advise to neither cut nor manipulate the cable at either end as this may lead to an incorrect position of the Skybell luminaires. Due to the weight and tension exerted by the catenary, we advise against using it on tile ceilings, 10 mm plasterboard or metal slats without reinforcing the anchor point by means of a self-supporting structure.

### Descripción lámpara / Lamps description:

230V 50Hz | IP-20 | 25.2 W LED / CRI: 90 / 2700°K | 3348 lm fuente de luz / light source

Ref	Acabados / Finishing	Ean13	Euros
35708219056	Regulable 0/1-10v/Dali/Push - Bell 55 cm Dimmable 0/1-10v/Dali/Push - Bell 55 cm	8435493724812	1.287,00

Familia / Family: Skybell Catenary

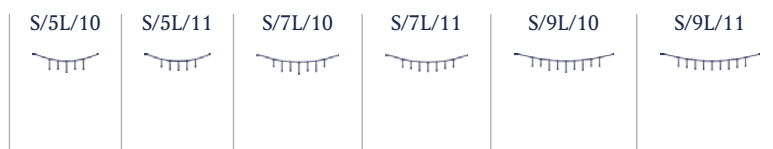

# Skybell Linear

Diseño / Design:  
Estudi Manel Molina / 2019

Tipología: Suspensión  
Typology: Pendant lamp

Ambiente: Interior  
Environment: Indoor

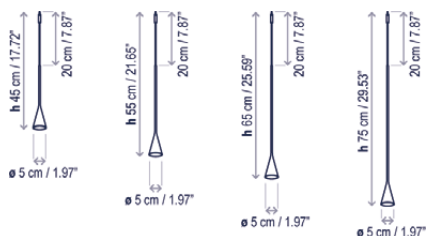

## S/5L/20

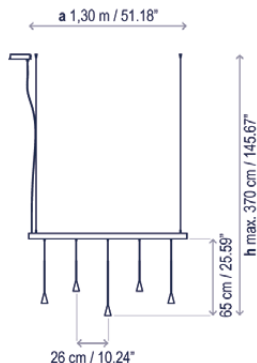

Luces / Lights  
1 x 65 cm / 25.59"  
2 x 55 cm / 21.65"  
2 x 45 cm / 17.72"

### Descripción técnica / Technical description:

Peso Neto: 2 kg  
Net Weight: 2 kg

1 Caja/Box | 47 x 14 x 24 cm | 0,0158 m<sup>3</sup>  
Peso bruto / Gross Weight: 1,15 kg

1 Tubo/Tube | 177 x Ø9 cm | 0,0113 m<sup>3</sup>  
Peso bruto / Gross Weight: 2,85 kg

Materiales: Hierro, Aluminio, Perfil de Extrusión de Aluminio.  
Materials: Iron, Aluminum, Extruded Aluminum Track.

Acabado estructura: color ébano negro  
Structure finish: ebony black

Óptica 30° apertura estándar  
Beam angle 30° standard

Opciones bajo pedido:  
· Driver remoto en falso techo  
· 3000K  
· Óptica 40°

Options upon request:  
· False ceiling remote driver  
· 3000K  
· Beam angle 40°

Personalizable  
Customizable

Certificaciones  
Certifications

Florón (S/5L/20)  
Canopy (S/5L/20)

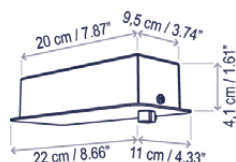

Florón (S/5L/22)  
Canopy (S/5L/22)

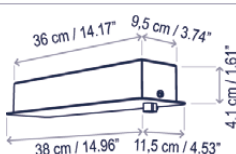

### Descripción lámpara iluminación inferior / Lower lighting lamp description:

230V 50Hz IP-20 14 W LED / CRI: 90 / 2700°K | 1860 lm fuente de luz / light source

Ref	Acabados / Finishing	Ean13	Euros
35711219056	Regulable 0/1-10v/Dali/Push Bell 45/55/65 cm Dimmable 0/1-10v/Dali/Push Bell 45/55/65 cm	8435493725192	854,00

## S/5L/22

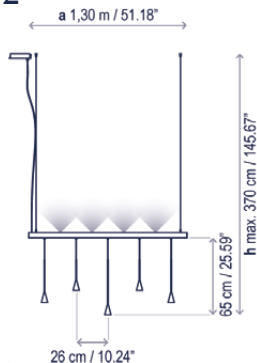

Luces / Lights  
1 x 65 cm / 25.59"  
2 x 55 cm / 21.65"  
2 x 45 cm / 17.72"

### Descripción lámpara iluminación superior e inferior / Upper and lower lighting lamp description:

230V 50Hz IP-20 12 W LED / CRI: 90 / 2700°K / 1440 lm fuente luz superior / upper light source | 14 W LED / CRI: 90 / 2700°K / 1860 lm fuente luz inferior / lower light source

Ref	Acabados / Finishing	Ean13	Euros
35729219056	Regulable 0/1-10v/Dali/Push Bell 45/55/65 cm Dimmable 0/1-10v/Dali/Push Bell 45/55/65 cm	8435493730479	1.090,00

Familia / Family: Skybell Linear

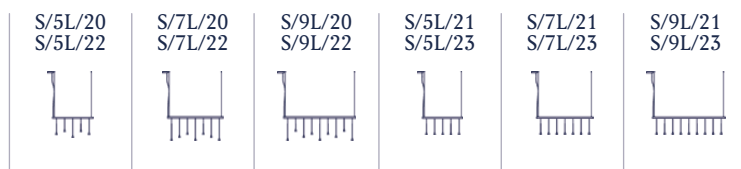



# Skybell Linear

Diseño / Design:  
Estudi Manel Molina / 2019

Tipología: Suspensión  
Typology: Pendant lamp

Ambiente: Interior  
Environment: Indoor

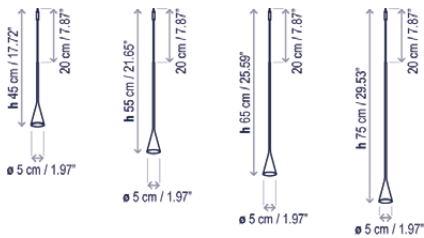

## S/7L/20

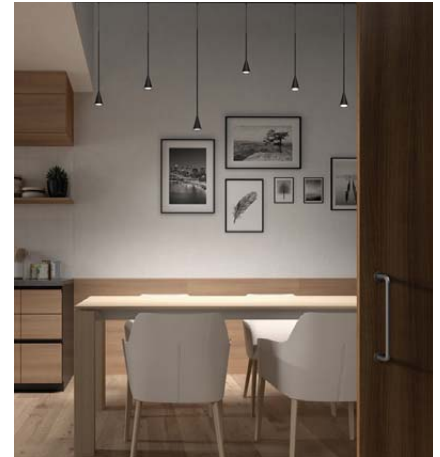
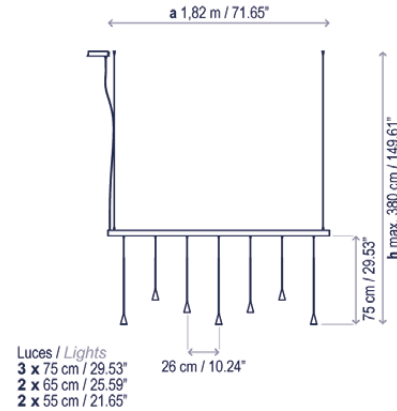

### Descripción técnica / Technical description:

Peso Neto: 2,79 kg  
Net Weight: 2,79 kg

1 Caja/Box | 55 x 55 x 25 cm | 0,0756 m<sup>3</sup>  
Peso bruto / Gross Weight: 2,17 kg

1 Tubo/Tube | 229 x Ø9 cm | 0,0146 m<sup>3</sup>  
Peso bruto / Gross Weight: 3,99 kg

Materiales: Hierro, Aluminio, Perfil de Extrusión de Aluminio.  
Materials: Iron, Aluminum, Extruded Aluminum Track.

Acabado estructura: color ébano negro  
Structure finish: ebony black

Óptica 30° apertura estándar  
Beam angle 30° standard

Opciones bajo pedido:  
· Driver remoto en falso techo  
· 3000K  
· Óptica 40°

Options upon request:  
· False ceiling remote driver  
· 3000K  
· Beam angle 40°

Personalizable  
Customizable

Certificaciones  
Certifications

Florón (S/7L/20)  
Canopy (S/7L/20)

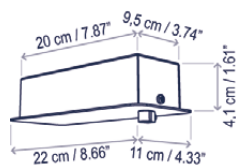

Florón (S/7L/22)  
Canopy (S/7L/22)

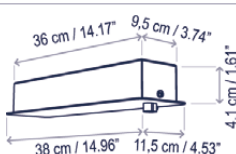

### Descripción lámpara iluminación inferior / Lower lighting lamp description:

230V 50Hz IP-20 0/1-10V / DALI / PUSH 19,6W LED / CRI: 90 / 2700°K | 2604 lm fuente de luz / light source

Ref	Acabados / Finishing	Ean13	Euros
35712219056	Regulable 0/1-10v/Dali/Push Bell 55/65/75 cm Dimmable 0/1-10v/Dali/Push Bell 55/65/75 cm	8435493724737	1.073,00

## S/7L/22

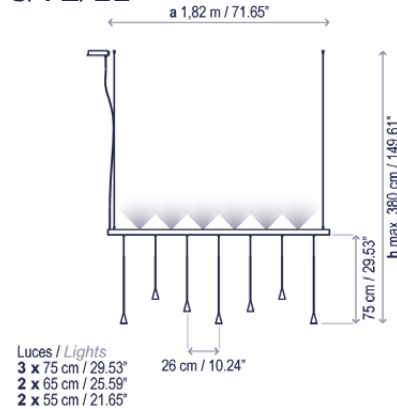

### Descripción lámpara iluminación superior e inferior / Upper and lower lighting lamp description:

230V 50Hz IP-20 0/1-10V / DALI / PUSH 18 W LED / CRI: 90 / 2700°K / 2160 lm fuente luz superior / upper light source | 19,6 W LED / CRI: 90 / 2700°K / 2604 lm fuente luz inferior / lower light source

Ref	Acabados / Finishing	Ean13	Euros
35731219056	Regulable 0/1-10v/Dali/Push Bell 55/65/75 cm Dimmable 0/1-10v/Dali/Push Bell 55/65/75 cm	8435493730516	1.300,00

Familia / Family: Skybell Linear

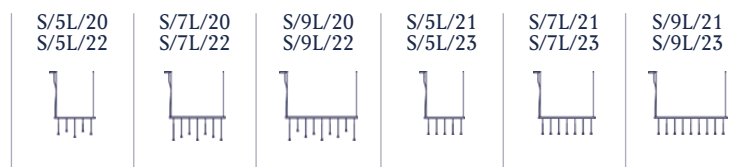

# Skybell Linear

Diseño / Design:  
Estudi Manel Molina / 2019

Tipología: Suspensión  
Typology: Pendant lamp

Ambiente: Interior  
Environment: Indoor

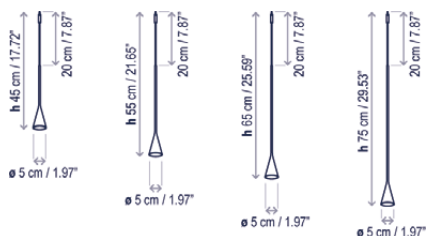

## S/9L/20

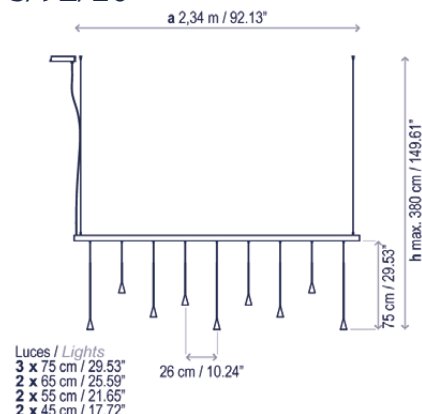

### Descripción técnica / Technical description:

Peso Neto: 3,6 kg  
Net Weight: 3,6 kg

1 Caja/Box | 55 x 55 x 25 cm | 0,0756 m<sup>3</sup>  
Peso bruto / Gross Weight: 2,72 kg

1 Tubo/Tube | 281 x Ø9 cm | 0,0179 m<sup>3</sup>  
Peso bruto / Gross Weight: 5,13 kg

Materiales: Hierro, Aluminio, Perfil de Extrusión de Aluminio.  
Materials: Iron, Aluminum, Extruded Aluminum Track.

Acabado estructura: color ébano negro  
Structure finish: ebony black

Óptica 30° apertura estándar  
Beam angle 30° standard

Opciones bajo pedido:  
· Driver remoto en falso techo  
· 3000K  
· Óptica 40°

Options upon request:  
· False ceiling remote driver  
· 3000K  
· Beam angle 40°

Personalizable  
Customizable

Certificaciones  
Certifications

Florón (S/9L/20)  
Canopy (S/9L/20)

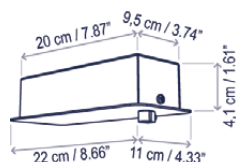

Florón (S/9L/22)  
Canopy (S/9L/22)

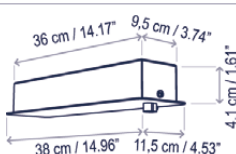

### Descripción lámpara iluminación inferior / Lower lighting lamp description:

230V 50Hz IP-20 0/1-10V / DALI / PUSH 25,2W LED / CRI: 90 / 2700°K 3348 lm fuente de luz / light source

Ref	Acabados / Finishing	Ean13	Euros
35713219056	Regulable 0/1-10v/Dali/Push Bell 45/55/65/75 cm Dimmable 0/1-10v/Dali/Push Bell 45/55/65/75 cm	8435493724775	1.313,00

## S/9L/22

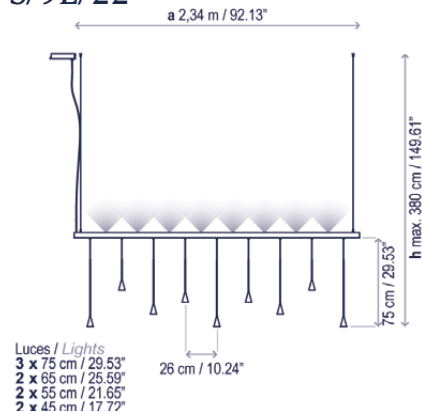

### Descripción lámpara iluminación superior e inferior / Upper and lower lighting lamp description:

230V 50Hz IP-20 0/1-10V / DALI / PUSH 24 W LED / CRI: 90 / 2700°K / 2880 lm fuente luz superior / upper light source 25,2 W LED / CRI: 90 / 2700°K / 3348 lm fuente luz inferior / lower light source

Ref	Acabados / Finishing	Ean13	Euros
35733219056	Regulable 0/1-10v/Dali/Push Bell 45/55/65/75 cm Dimmable 0/1-10v/Dali/Push Bell 45/55/65/75 cm	8435493730554	1.584,00

Familia / Family: Skybell Linear

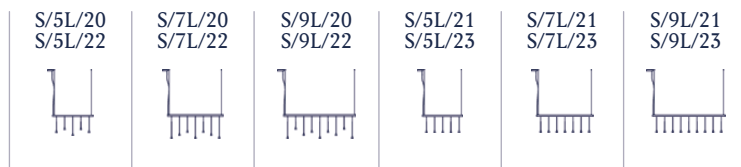

# Skybell Linear

Diseño / Design:  
Estudi Manel Molina / 2019

Tipología: Suspensión  
Typology: Pendant lamp

Ambiente: Interior  
Environment: Indoor

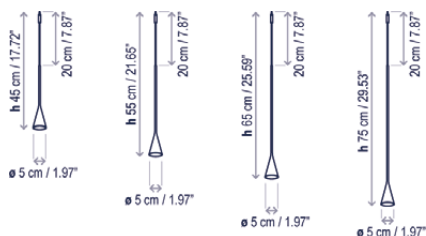

## S/5L/21

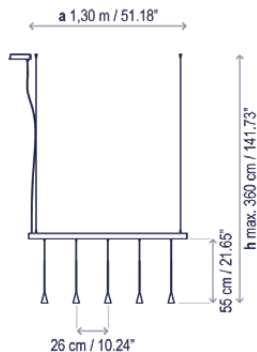

Luces / Lights  
5 x 55 cm / 21.65"



### Descripción técnica / Technical description:

Peso Neto: 2 kg  
Net Weight: 2 kg

1 Caja/Box | 47 x 14 x 24 cm | 0,0158 m<sup>3</sup>  
Peso bruto / Gross Weight: 1,15 kg

1 Tubo/Tube | 177 x Ø9 cm | 0,0113 m<sup>3</sup>  
Peso bruto / Gross Weight: 2,85 kg

Materiales: Hierro, Aluminio, Perfil de Extrusión de Aluminio.  
Materials: Iron, Aluminum, Extruded Aluminum Track.

Acabado estructura: color ébano negro  
Structure finish: ebony black

Óptica 30° apertura estándar  
Beam angle 30° standard

Opciones bajo pedido:  
· Driver remoto en falso techo  
· 3000K  
· Óptica 40°

Options upon request:  
· False ceiling remote driver  
· 3000K  
· Beam angle 40°

Personalizable  
Customizable

Certificaciones  
Certifications

Florón (S/5L/21)  
Canopy (S/5L/21)

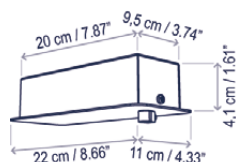

Florón (S/5L/23)  
Canopy (S/5L/23)

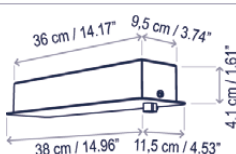

### Descripción lámpara iluminación inferior / Lower lighting lamp description:

230V 50Hz IP-20 0/1-10V / DALI / PUSH 14 W LED / CRI: 90 / 2700°K | 1860 lm fuente de luz / light source

Ref	Acabados / Finishing	Ean13	Euros
35715219056	Regulable 0/1-10v/Dali/Push - Bell 55 cm Dimmable 0/1-10v/Dali/Push - Bell 55 cm	8435493724744	854,00

## S/5L/23

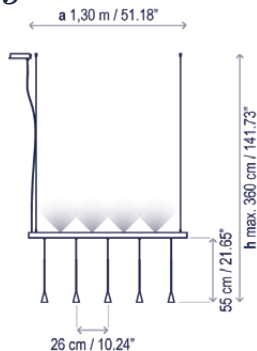

Luces / Lights  
5 x 55 cm / 21.65"

### Descripción lámpara iluminación superior e inferior / Upper and lower lighting lamp description:

230V 50Hz IP-20 0/1-10V / DALI / PUSH 12 W LED / CRI: 90 / 2700°K / 1440 lm fuente luz superior / upper light source | 14 W LED / CRI: 90 / 2700°K / 1860 lm fuente luz inferior / lower light source

Ref	Acabados / Finishing	Ean13	Euros
35730219056	Regulable 0/1-10v/Dali/Push - Bell 55 cm Dimmable 0/1-10v/Dali/Push - Bell 55 cm	8435493730493	1.090,00

Familia / Family: Skybell Linear

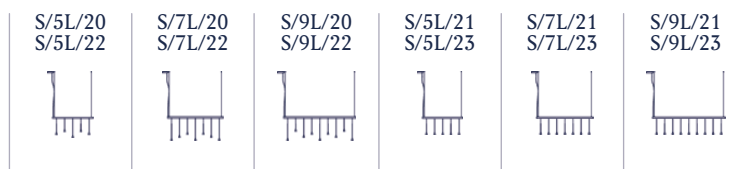

# Skybell Linear

Diseño / Design:  
Estudi Manel Molina / 2019

Tipología: Suspensión  
Typology: Pendant lamp

Ambiente: Interior  
Environment: Indoor

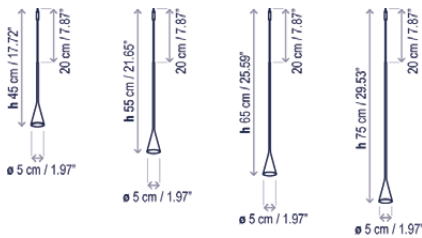

## S/7L/21

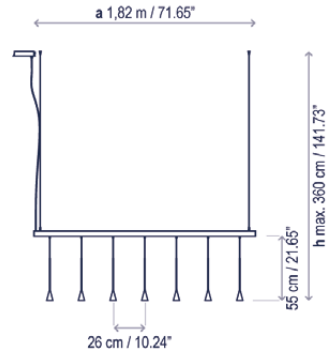

Luces / Lights  
7 x 55 cm / 21.65"



### Descripción técnica / Technical description:

Peso Neto: 2,79 kg  
Net Weight: 2,79 kg

1 Caja/Box | 55 x 55 x 25 cm | 0,0756 m<sup>3</sup>  
Peso bruto / Gross Weight: 2,17 kg

1 Tubo/Tube | 229 x Ø9 cm | 0,0146 m<sup>3</sup>  
Peso bruto / Gross Weight: 3,99 kg

Materiales: Hierro, Aluminio, Perfil de Extrusión de Aluminio.  
Materials: Iron, Aluminum, Extruded Aluminum Track.

Acabado estructura: color ébano negro  
Structure finish: ebony black

Óptica 30° apertura estándar  
Beam angle 30° standard

Opciones bajo pedido:  
· Driver remoto en falso techo  
· 3000K  
· Óptica 40°

Options upon request:  
· False ceiling remote driver  
· 3000K  
· Beam angle 40°

Personalizable  
Customizable

Certificaciones  
Certifications

Florón (S/7L/21)  
Canopy (S/7L/21)

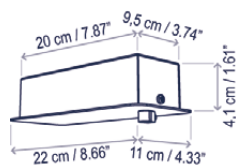

Florón (S/7L/23)  
Canopy (S/7L/23)

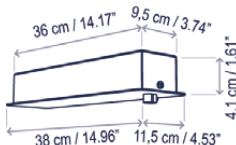

### Descripción lámpara iluminación inferior / Lower lighting lamp description:

230V 50Hz IP-20 0/1-10V / DALI / PUSH 19,6W LED / CRI: 90 / 2700°K | 2604 lm fuente de luz / light source

Ref	Acabados / Finishing	Ean13	Euros
35716219056	Regulable 0/1-10v/Dali/Push - Bell 55 cm Dimmable 0/1-10v/Dali/Push - Bell 55 cm	8435493724843	1.073,00

## S/7L/23

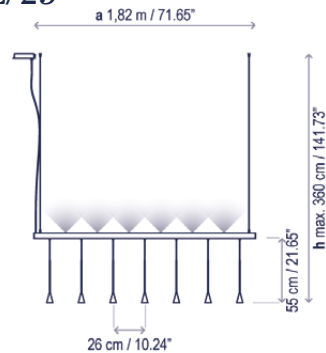

Luces / Lights  
7 x 55 cm / 21.65"

### Descripción lámpara iluminación superior e inferior / Upper and lower lighting lamp description:

230V 50Hz IP-20 0/1-10V / DALI / PUSH 18 W LED / CRI: 90 / 2700°K / 2160 lm fuente luz superior / upper light source | 19,6 W LED / CRI: 90 / 2700°K / 2604 lm fuente luz inferior / lower light source

Ref	Acabados / Finishing	Ean13	Euros
35732219056	Regulable 0/1-10v/Dali/Push - Bell 55 cm Dimmable 0/1-10v/Dali/Push - Bell 55 cm	8435493730523	1.300,00

Familia / Family: Skybell Linear

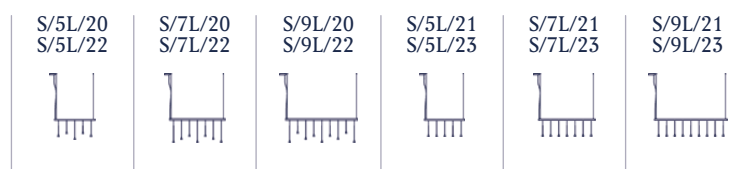

# Skybell Linear

Diseño / Design:  
Estudi Manel Molina / 2019

Tipología: Suspensión  
Typology: Pendant lamp

Ambiente: Interior  
Environment: Indoor

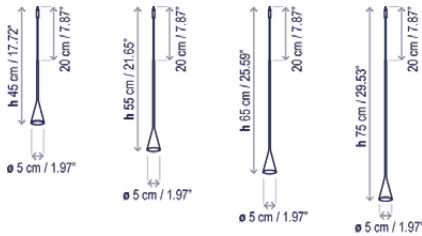

## S/9L/21

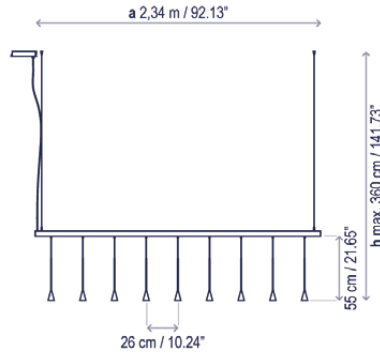

Luces / Lights  
9 x 55 cm / 21.65"

### Descripción técnica / Technical description:

Peso Neto: 3,6 kg  
Net Weight: 3,6 kg

1 Caja/Box | 55 x 55 x 25 cm | 0,0756 m<sup>3</sup>  
Peso bruto / Gross Weight: 2,72 kg

1 Tubo/Tube | 281 x Ø9 cm | 0,0179 m<sup>3</sup>  
Peso bruto / Gross Weight: 5,13 kg

Materiales: Hierro, Aluminio, Perfil de Extrusión de Aluminio.  
Materials: Iron, Aluminum, Extruded Aluminum Track.

Acabado estructura: color ébano negro  
Structure finish: ebony black

Óptica 30° apertura estándar  
Beam angle 30° standard

Opciones bajo pedido:  
· Driver remoto en falso techo  
· 3000K  
· Óptica 40°

Options upon request:  
· False ceiling remote driver  
· 3000K  
· Beam angle 40°

Personalizable  
Customizable

Certificaciones  
Certifications

Florón (S/9L/21)  
Canopy (S/9L/21)

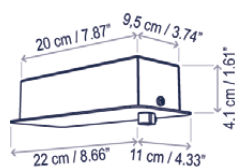

Florón (S/9L/23)  
Canopy (S/9L/23)

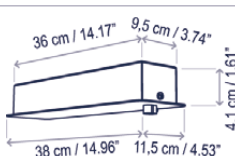

### Descripción lámpara iluminación inferior / Lower lighting lamp description:

230V 50Hz IP-20 0/1-10V / DALI / PUSH 25,2W LED / CRI: 90 / 2700°K 3348 lm fuente de luz / light source

Ref	Acabados / Finishing	Ean13	Euros
35717219056	Regulable 0/1-10v/Dali/Push - Bell 55 cm Dimmable 0/1-10v/Dali/Push - Bell 55 cm	8435493724850	1.313,00

## S/9L/23

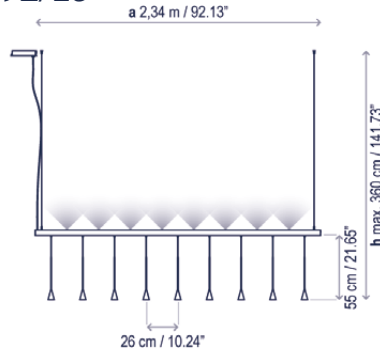

Luces / Lights  
9 x 55 cm / 21.65"

### Descripción lámpara iluminación superior e inferior / Upper and lower lighting lamp description:

230V 50Hz IP-20 0/1-10V / DALI / PUSH 24 W LED / CRI: 90 / 2700°K / 2880 lm fuente luz superior / upper light source 25,2 W LED / CRI: 90 / 2700°K / 3348 lm fuente luz inferior / lower light source

Ref	Acabados / Finishing	Ean13	Euros
35734219056	Regulable 0/1-10v/Dali/Push - Bell 55 cm Dimmable 0/1-10v/Dali/Push - Bell 55 cm	8435493730578	1.584,00

Familia / Family: Skybell Linear

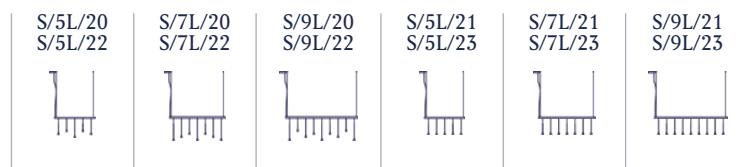



# Skybell Circle

Diseño / Design:  
Estudi Manel Molina / 2019

Tipología: Suspensión  
Typology: Pendant lamp

Ambiente: Interior  
Environment: Indoor

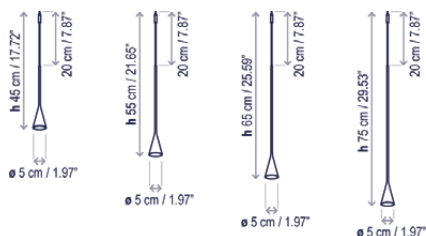

S/12L/40

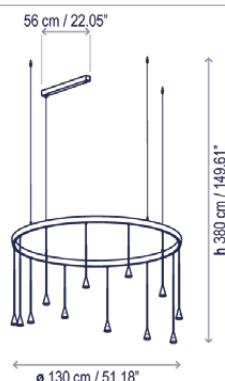

Luces / Lights  
2 x 75 cm / 29.53"  
4 x 65 cm / 25.59"  
4 x 55 cm / 21.65"  
2 x 45 cm / 17.72"



Descripción técnica / Technical description:

Peso Neto: 4,53 kg  
Net Weight: 4,53 kg

1 Caja/Box | 153 x 85 x 17 cm | 0,2211 m<sup>3</sup>  
Peso bruto / Gross Weight: 12,93 kg

Materiales: Hierro, aluminio  
Materials: Iron, Aluminum

Acabado estructura: color ébano negro  
Structure finish: ebony black

Óptica 30° apertura estándar  
Beam angle 30° standard

Opciones bajo pedido:  
· Driver remoto en falso techo  
· 3000K  
· Óptica 40°

Options upon request:  
· False ceiling remote driver  
· 3000K  
· Beam angle 40°

Personalizable  
Customizable

Certificaciones  
Certifications

Descripción lámpara iluminación inferior / Lower lighting lamp description:

230V 50Hz IP-20 33,6 W LED / CRI: 90 / 2700°K  
4464 lm fuente de luz / light source

Ref	Acabados / Finishing	Ean13	Euros
35722219056	Regulable 0/1-10v/Dali/Push Bell 45/55/65/75 cm Dimmable 0/1-10v/Dali/Push Bell 45/55/65/75 cm	8435493731995	1.923,00

S/12L/42



Luces / Lights  
2 x 75 cm / 29.53"  
4 x 65 cm / 25.59"  
4 x 55 cm / 21.65"  
2 x 45 cm / 17.72"

Descripción lámpara iluminación superior e inferior / Upper and lower lighting lamp description:

230V 50Hz IP-20 24 W LED / CRI: 90 / 2700°K / 2880 lm fuente luz superior / upper light source  
33,6 W LED / CRI: 90 / 2700°K / 4464 lm fuente luz inferior / lower light source

Ref	Acabados / Finishing	Ean13	Euros
35743219056	Regulable 0/1-10v/Dali/Push Bell 45/55/65/75 cm Dimmable 0/1-10v/Dali/Push Bell 45/55/65/75 cm	8435493732008	2.232,00

Family / Familia: Skybell Circle

S/12L/40 S/12L/42	S/16L/40 S/16L/42	S/20L/40 S/20L/42	S/30L/40 S/30L/42	S/62L/40 S/62L/42



# Skybell Circle

Diseño / Design:  
Estudi Manel Molina / 2019

Tipología: Suspensión  
Typology: Pendant lamp

Ambiente: Interior  
Environment: Indoor

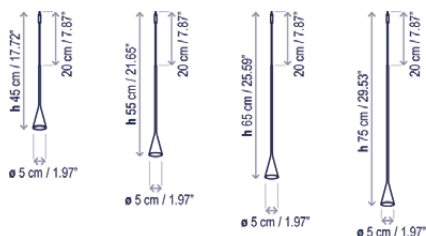

## Descripción técnica / Technical description:

Peso Neto: 7,53 kg  
Net Weight: 7,53 kg

1 Caja/Box | 170 x 85 x 17 cm | 0,2457 m<sup>3</sup>  
Peso bruto / Gross Weight: 18,93 kg

Materiales: Hierro, aluminio  
Materials: Iron, Aluminum

Acabado estructura: color ébano negro  
Structure finish: ebony black

Óptica 30° apertura estándar  
Beam angle 30° standard

Opciones bajo pedido:  
· Driver remoto en falso techo  
· 3000K  
· Óptica 40°

Options upon request:  
· False ceiling remote driver  
· 3000K  
· Beam angle 40°

Personalizable  
Customizable

Certificaciones  
Certifications

## S/16L/40

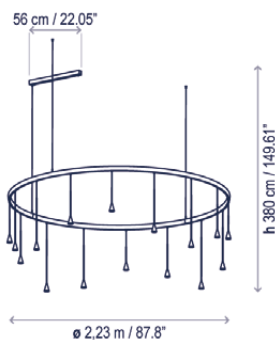

Luces / Lights  
4 x 75 cm / 29.53"  
4 x 65 cm / 25.59"  
4 x 55 cm / 21.65"  
4 x 45 cm / 17.72"

## Descripción lámpara iluminación inferior / Lower lighting lamp description:

230V 50Hz IP-20 44,8 W LED / CRI: 90 / 2700°K  
5952 lm fuente de luz / light source

Ref	Acabados / Finishing	Ean13	Euros
35752219056	Regulable 0/1-10v/Dali/Push Bell 45/55/65/75 cm Dimmable 0/1-10v/Dali/Push Bell 45/55/65/75 cm	8435493732015	3.034,00

## S/16L/42

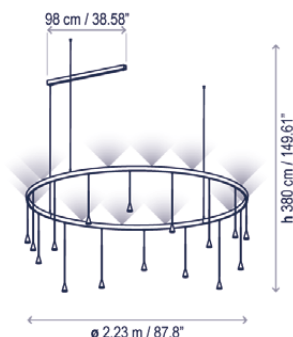

Luces / Lights  
4 x 75 cm / 29.53"  
4 x 65 cm / 25.59"  
4 x 55 cm / 21.65"  
4 x 45 cm / 17.72"

## Descripción lámpara iluminación superior e inferior / Upper and lower lighting lamp description:

230V 50Hz IP-20 36 W LED / CRI: 90 / 2700°K / 4320 lm fuente luz superior / upper light source  
44,8 W LED / CRI: 90 / 2700°K / 5952 lm fuente luz inferior / lower light source

Ref	Acabados / Finishing	Ean13	Euros
35753219056	Regulable 0/1-10v/Dali/Push Bell 45/55/65/75 cm Dimmable 0/1-10v/Dali/Push Bell 45/55/65/75 cm	8435493732022	3.412,00

Familia / Family: Skybell Circle

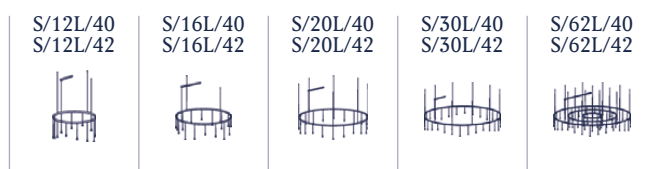

# Skybell Circle

Diseño / Design:  
Estudi Manel Molina / 2019

Tipología: Suspensión  
Typology: Pendant lamp

Ambiente: Interior  
Environment: Indoor

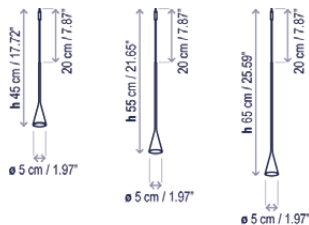

## S/20L/40

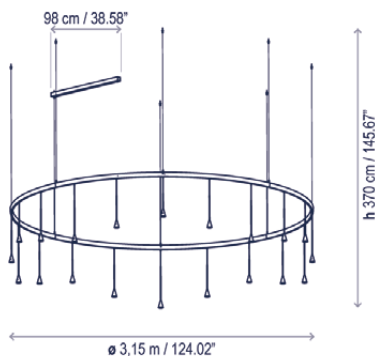

Luces / Lights  
5 x 65 cm / 25.59"  
10 x 55 cm / 21.65"  
5 x 45 cm / 17.72"

### Descripción técnica / Technical description:

Peso Neto: 9,56 kg  
Net Weight: 9,56 kg

1 Caja/Box | 250 x 85 x 17 cm | 0,3613 m<sup>3</sup>  
Peso bruto / Gross Weight: 23,1 kg

Materiales: Hierro, aluminio  
Materials: Iron, Aluminum

Acabado estructura: color ébano negro  
Structure finish: ebony black

Óptica 30° apertura estándar  
Beam angle 30° standard

Opciones bajo pedido:  
· Driver remoto en falso techo  
· 3000K  
· Óptica 40°

Options upon request:  
· False ceiling remote driver  
· 3000K  
· Beam angle 40°

Personalizable  
Customizable

Certificaciones  
Certifications

### Descripción lámpara iluminación inferior / Lower lighting lamp description:

230V 50Hz IP-20 0/1-10V / DALI / PUSH 56 W LED / CRI: 90 / 2700°K  
7440 lm fuente de luz / light source

Ref	Acabados / Finishing	Ean13	Euros
35723219056	Regulable 0/1-10v/Dali/Push Bell 45/55/65 cm Dimmable 0/1-10v/Dali/Push Bell 45/55/65 cm	8435493732039	3.519,00

## S/20L/42

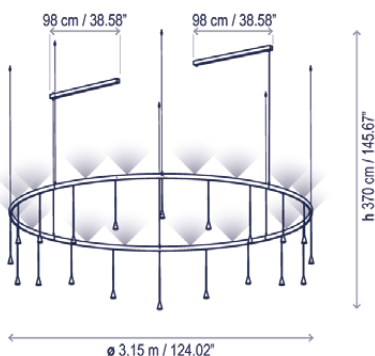

Luces / Lights  
5 x 65 cm / 25.59"  
10 x 55 cm / 21.65"  
5 x 45 cm / 17.72"

### Descripción lámpara iluminación superior e inferior / Upper and lower lighting lamp description:

230V 50Hz IP-20 0/1-10V / DALI / PUSH 48 W LED / CRI: 90 / 2700°K / 5760 lm fuente luz superior / upper light source  
56 W LED / CRI: 90 / 2700°K / 7440 lm fuente luz inferior / lower light source

Ref	Acabados / Finishing	Ean13	Euros
35744219056	Regulable 0/1-10v/Dali/Push Bell 45/55/65 cm Dimmable 0/1-10v/Dali/Push Bell 45/55/65 cm	8435493732046	4.004,00

Family / Familia: Skybell Circle

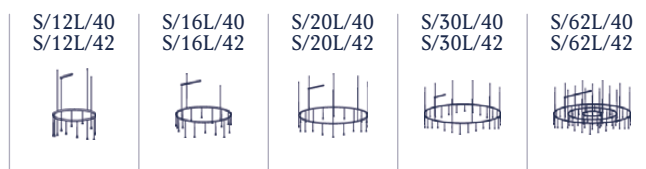

# Skybell Circle

Diseño / Design:  
Estudi Manel Molina / 2019

Tipología: Suspensión  
Typology: Pendant lamp

Ambiente: Interior  
Environment: Indoor

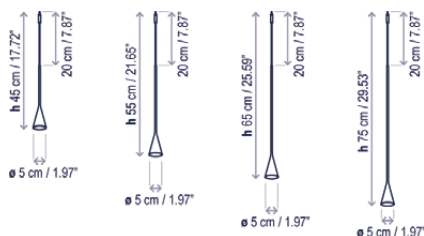

## S/30L/40

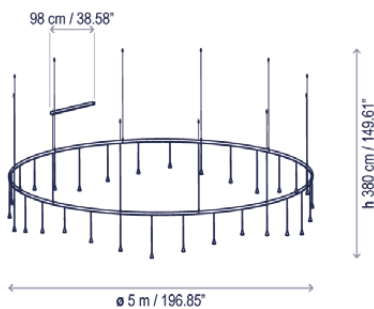

Luces / Lights  
5 x 75 cm / 29.53"  
10 x 65 cm / 25.59"  
10 x 55 cm / 21.65"  
5 x 45 cm / 17.72"

### Descripción técnica / Technical description:

Peso Neto: 14,89 kg  
Net Weight: 14,89 kg

1 Caja/Box | 260 x 85 x 17 cm | 0,3757 m<sup>3</sup>  
Peso bruto / Gross Weight: 29,8 kg

Materiales: Hierro, aluminio  
Materials: Iron, Aluminum

Acabado estructura: color ébano negro  
Structure finish: ebony black

Óptica 30° apertura estándar  
Beam angle 30° standard

Opciones bajo pedido:  
· Driver remoto en falso techo  
· 3000K  
· Óptica 40°

Options upon request:  
· False ceiling remote driver  
· 3000K  
· Beam angle 40°

Personalizable  
Customizable

Certificaciones  
Certifications

### Descripción lámpara iluminación inferior / Lower lighting lamp description:

230V 50Hz IP-20 0/1-10V / DALI / PUSH 84 W LED / CRI: 90 / 2700°K  
11160 lm fuente de luz / light source

Ref	Acabados / Finishing	Ean13	Euros
35724219056	Regulable 0/1-10v/Dali/Push Bell 45/55/65/75 cm Dimmable 0/1-10v/Dali/Push Bell 45/55/65/75 cm	8435493732053	5.115,00

## S/30L/42

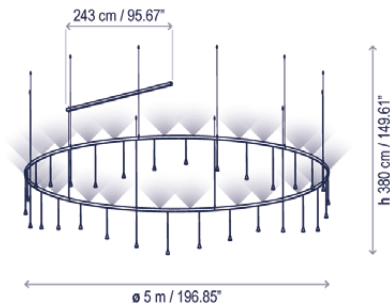

Luces / Lights  
5 x 75 cm / 29.53"  
10 x 65 cm / 25.59"  
10 x 55 cm / 21.65"  
5 x 45 cm / 17.72"

### Descripción lámpara iluminación superior e inferior / Upper and lower lighting lamp description:

230V 50Hz IP-20 0/1-10V / DALI / PUSH 72 W LED / CRI: 90 / 2700°K / 8640 lm fuente luz superior / upper light source  
84 W LED / CRI: 90 / 2700°K / 11160 lm fuente luz inferior / lower light source

Ref	Acabados / Finishing	Ean13	Euros
35745219056	Regulable 0/1-10v/Dali/Push Bell 45/55/65/75 cm Dimmable 0/1-10v/Dali/Push Bell 45/55/65/75 cm	8435493732060	5.841,00

Familia / Family: Skybell Circle

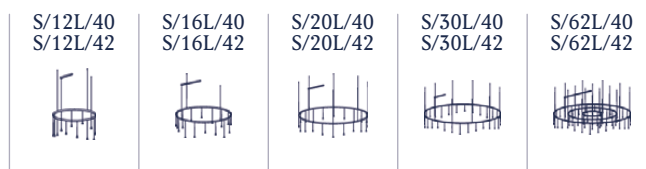

# Skybell Circle

Diseño / Design:  
Estudi Manel Molina / 2019

Tipología: Suspensión  
Typology: Pendant lamp

Ambiente: Interior  
Environment: Indoor

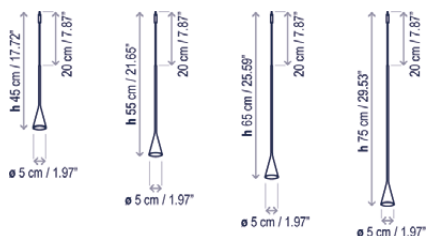

## Descripción técnica / Technical description:

**Peso Neto: 32 kg**  
Net Weight: 32 kg

3 Cajas / 3 Boxes:

1 Caja/Box | 153 x 85 x 17 cm | 0,2211 m<sup>3</sup>  
Peso bruto / Gross Weight: 12,93 kg

1 Caja/Box | 250 x 85 x 17 cm | 0,3613 m<sup>3</sup>  
Peso bruto / Gross Weight: 23,1 kg

1 Caja/Box | 260 x 85 x 17 cm | 0,3757 m<sup>3</sup>  
Peso bruto / Gross Weight: 32,8 kg

Materiales: Hierro, aluminio  
Materials: Iron, Aluminum

Acabado estructura: color ébano negro  
Structure finish: ebony black

Óptica 30° apertura estándar  
Beam angle 30° standard

Opciones bajo pedido:  
· Driver remoto en falso techo  
· 3000K  
· Óptica 40°

Options upon request:  
· False ceiling remote driver  
· 3000K  
· Beam angle 40°

Personalizable  
Customizable

Certificaciones  
Certifications

## S/62L/40

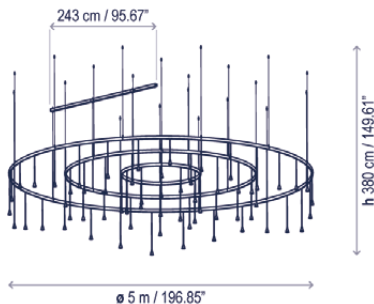

Luces / Lights  
7 x 75 cm / 29.53"  
19 x 65 cm / 25.59"  
24 x 55 cm / 21.65"  
12 x 45 cm / 17.72"



## Descripción lámpara iluminación inferior / Lower lighting lamp description:

230V 50Hz | IP-20 | 0/1-10V / DALI / PUSH | 173,6 W LED / CRI:90 / 2700°K | 25064 lm fuente de luz / light source |

Ref	Acabados / Finishing	Ean13	Euros
35725219056	Regulable 0/1-10v/Dali/Push Bell 45/55/65/75 cm Dimmable 0/1-10v/Dali/Push Bell 45/55/65/75 cm	8435493732077	10.557,00

## S/62L/42

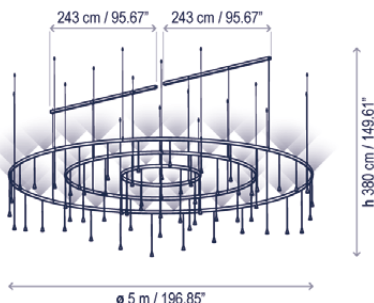

Luces / Lights  
7 x 75 cm / 29.53"  
19 x 65 cm / 25.59"  
24 x 55 cm / 21.65"  
12 x 45 cm / 17.72"

## Descripción lámpara iluminación superior e inferior / Upper and lower lighting lamp description:

230V 50Hz | IP-20 | 0/1-10V / DALI / PUSH | 144 W LED / CRI:90 / 2700°K / 17280 lm fuente luz superior / upper light source | 173,6 W LED / CRI:90 / 2700°K / 25064 lm fuente luz inferior / lower light source |

Ref	Acabados / Finishing	Ean13	Euros
35746219056	Regulable 0/1-10v/Dali/Push Bell 45/55/65/75 cm Dimmable 0/1-10v/Dali/Push Bell 45/55/65/75 cm	8435493732084	12.072,00

Family / Familia: Skybell Circle

S/12L/40 S/12L/42	S/16L/40 S/16L/42	S/20L/40 S/20L/42	S/30L/40 S/30L/42	S/62L/40 S/62L/42

# Skybell Modular S/20L/40

Diseño / Design:  
Estudi Manel Molina / 2019

Tipología: Suspensión  
Typology: Pendant lamp

Ambiente: Interior  
Environment: Indoor

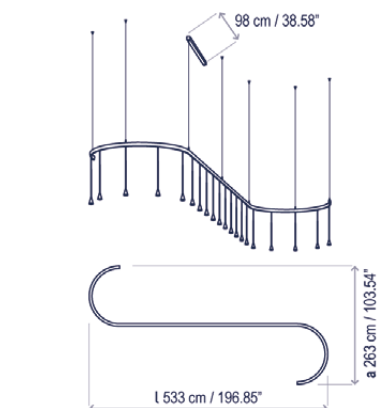

Luces / Lights  
20 x 65 cm / 25.59"



## Descripción técnica / Technical description:

Peso Neto: 6,9 kg  
Net Weight: 6,9 kg

1 Caja/Box | 153 x 85 x 17 cm | 0,2211 m<sup>3</sup>  
Peso bruto / Gross Weight: 10,68 kg

2 Tubos/Tubes | 215 x Ø9 cm | 0,0274 m<sup>3</sup>  
Peso bruto / Gross Weight: 8,77 kg

Materiales: Hierro, aluminio  
Materials: Iron, Aluminum

Acabado estructura: color ébano negro  
Structure finish: ebony black

10 luces en las secciones rectas  
5 luces en las secciones curvas  
10 lights in the straight sections  
5 lights in the curved sections

Óptica 30° apertura estándar  
Beam angle 30° standard

Opciones bajo pedido:  
· Driver remoto en falso techo  
· 3000K  
· Óptica 40°

Options upon request:  
· False ceiling remote driver  
· 3000K  
· Beam angle 40°

Personalizable  
Customizable

Certificaciones  
Certifications



## Descripción lámpara / Lamps description:

230V 50Hz IP-20 0/1-10V / DALI / PUSH 56 W LED / CRI: 90 / 2700°K 7440 lm fuente de luz / light source

Ref	Acabados / Finishing	Ean13	Euros
35726219056	Regulable 0/1-10v/Dali/Push - Bell 65 cm Dimmable 0/1-10v/Dali/Push - Bell 65 cm	8435493732091	2.940,00

# Slend 01

Diseño / Design:  
Christophe Mathieu / 2014

Tipología: Suspensión  
Typology: Pendant lamp

Ambiente: Interior  
Environment: Indoor

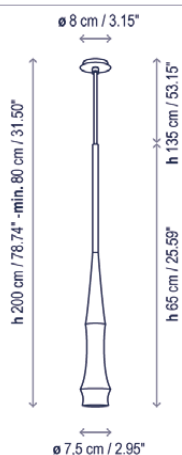

## Descripción técnica / Technical description:

Peso Neto: 1,1 kg  
Net Weight: 1,1 kg

1 Caja/Box | 18 x 80 x 15 cm | 0,0216 m<sup>3</sup>  
Peso bruto / Gross Weight: 1,87 kg

Materiales: Aluminio, Hierro  
Materials: Aluminum, Iron

Pantalla realizada de una pieza de aluminio macizo. La abertura de la pantalla que alberga la fuente de luz está revestida de cobre.  
Shade made of a solid aluminum piece. Copper lined aperture houses direct light source.

Personalizable  
Customizable

Bombillas no incluidas  
Bulbs not included

Certificaciones  
Certifications

## Descripción lámpara / Lamps description:

230V 50Hz | IP-20 | 1 x 6 W GU10 LED

Ref	Acabados / Finishing	Ean13	Euros
2560120000	Blanco Mate Matte White	8435493729084	321,00
2560120012	Negro Mate Matte Black	8435493729091	321,00

## Familia / Family: Slend

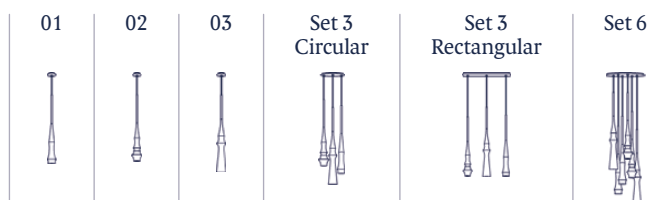



# Slend 02

Diseño / Design:  
Christophe Mathieu / 2014

Tipología: Suspensión  
Typology: Pendant lamp

Ambiente: Interior  
Environment: Indoor

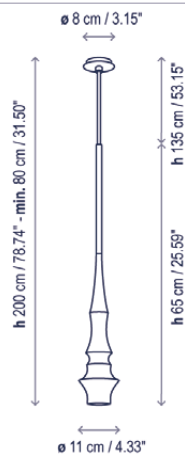

## Descripción técnica / Technical description:

Peso Neto: 1,79 kg  
Net Weight: 1,79 kg

1 Caja/Box | 18 x 80 x 15 cm | 0,0216 m<sup>3</sup>  
Peso bruto / Gross Weight: 2,56 kg

Materiales: Aluminio, Hierro  
Materials: Aluminum, Iron

Pantalla realizada de una pieza de aluminio macizo. La abertura de la pantalla que alberga la fuente de luz está revestida de cobre.  
Shade made of a solid aluminum piece. Copper lined aperture houses direct light source.

Personalizable  
Customizable

Bombillas no incluidas  
Bulbs not included

Certificaciones  
Certifications

## Descripción lámpara / Lamps description:

230V 50Hz | IP-20 1 x 6 W GU10 LED

Ref	Acabados / Finishing	Ean13	Euros
2560220000	Blanco Mate Matte White	8435493729107	405,00
2560220012	Negro Mate Matte Black	8435493729411	405,00

## Familia / Family: Slend

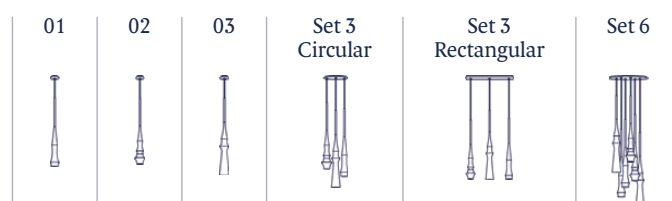

# Slend 03

Diseño / Design:  
Christophe Mathieu / 2014

Tipología: Suspensión  
Typology: Pendant lamp

Ambiente: Interior  
Environment: Indoor

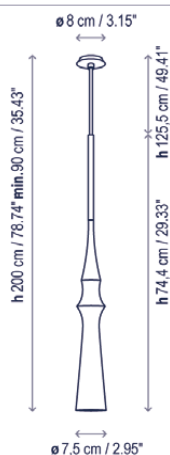

## Descripción técnica / Technical description:

Peso Neto: 1,83 kg  
Net Weight: 1,83 kg

1 Caja/Box | 18 x 80 x 15 cm | 0,0216 m<sup>3</sup>  
Peso bruto / Gross Weight: 2,6 kg

Materiales: Aluminio, Hierro  
Materials: Aluminum, Iron

Pantalla realizada de una pieza de aluminio macizo. La abertura de la pantalla que alberga la fuente de luz está revestida de cobre.  
Shade made of a solid aluminum piece. Copper lined aperture houses direct light source.

Personalizable  
Customizable

Bombillas no incluidas  
Bulbs not included

Certificaciones  
Certifications

## Descripción lámpara / Lamps description:

230V 50Hz | IP-20 | 1 x 6 W GU10 LED

Ref	Acabados / Finishing	Ean13	Euros
2560320000	Blanco Mate Matte White	8435493729428	405,00
2560320012	Negro Mate Matte Black	8435493729671	405,00

## Familia / Family: Slend

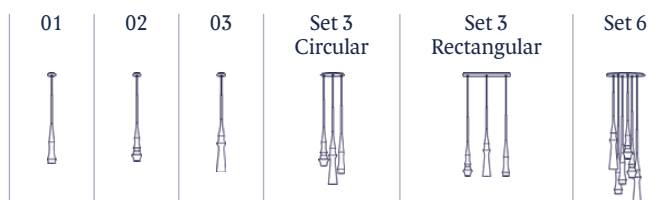

# Slend Set 3/Circular

Diseño / Design:  
Christophe Mathieu / 2014

Tipología: Suspensión  
Typology: Pendant lamp

Ambiente: Interior  
Environment: Indoor

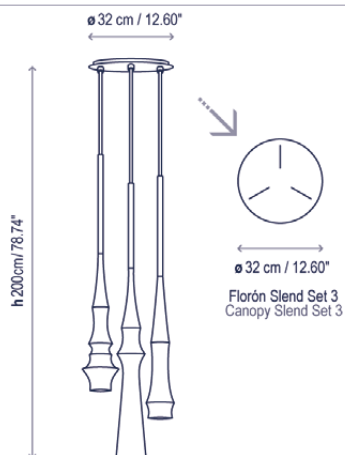

## Descripción técnica / Technical description:

Peso Neto: 6,65 kg  
Net Weight: 6,65 kg

1 Caja/Box | 53 x 103 x 41 cm | 0,2238 m<sup>3</sup>  
Peso bruto / Gross Weight: 12,09 kg

Materiales: Aluminio, Hierro  
Materials: Aluminum, Iron

Pantalla realizada de una pieza de aluminio macizo. La abertura de la pantalla que alberga la fuente de luz está revestida de cobre.  
Shade made of a solid aluminum piece. Copper lined aperture houses direct light source.

Las ranuras en el florón permiten ajustar la posición de las luminarias durante la instalación.  
Canopy features slots for the cable connection to allow adjustability of the cluster on placement.

Personalizable  
Customizable

Bombillas no incluidas  
Bulbs not included

Certificaciones  
Certifications

## Descripción lámpara / Lamps description:

230V 50Hz | IP-20 3 x 6 W GU10 LED

Ref	Acabados / Finishing	Ean13	Euros
2560420000	Blanco Mate - Florón Blanco Matte White - White Canopy	8435493729114	1.170,00
2560420012	Negro Mate - Florón Negro Matte Black - Black Canopy	8435493729664	1.170,00

## Familia / Family: Slend

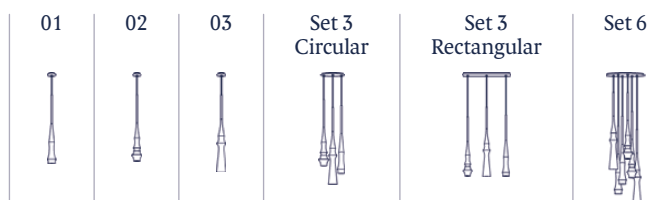

# Slend Set 3/Rectangular

Diseño / Design:  
Christophe Mathieu / 2014

Tipología: Suspensión  
Typology: Pendant lamp

Ambiente: Interior  
Environment: Indoor

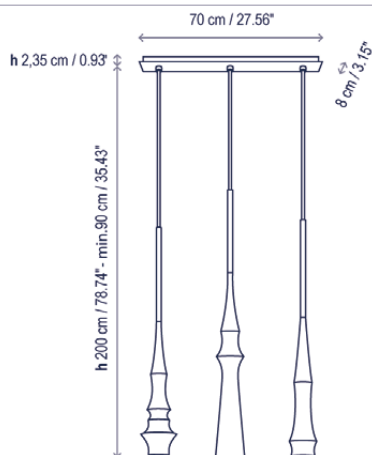

## Descripción técnica / Technical description:

 Peso Neto: 6,94 kg  
Net Weight: 6,94 kg

 1 Caja/Box | 53 x 103 x 41 cm | 0,2238 m<sup>3</sup>  
Peso bruto / Gross Weight: 12,09 kg

Materiales: Aluminio, Hierro  
Materials: Aluminum, Iron

Pantalla realizada de una pieza de aluminio macizo. La abertura de la pantalla que alberga la fuente de luz está revestida de cobre.  
Shade made of a solid aluminum piece. Copper lined aperture houses direct light source.

Personalizable  
Customizable

Bombillas no incluidas  
Bulbs not included

Certificaciones  
Certifications  

## Descripción lámpara / Lamps description:

  230V 50Hz | IP-20 |   3 x 6 W GU10 LED

Ref	Acabados / Finishing	Ean13	Euros
2560620000	Blanco Mate - Florón Blanco Matte White - White Canopy	8435493729121	1.148,00
2560620012	Negro Mate - Florón Negro Matte Black - Black Canopy	8435493729138	1.148,00

## Familia / Family: Slend

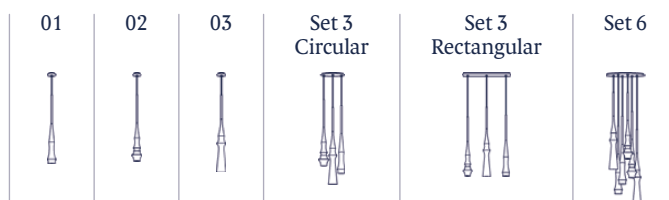

# Slend Set 6

Diseño / Design:  
Christophe Mathieu / 2014

Tipología: Suspensión  
Typology: Pendant lamp

Ambiente: Interior  
Environment: Indoor

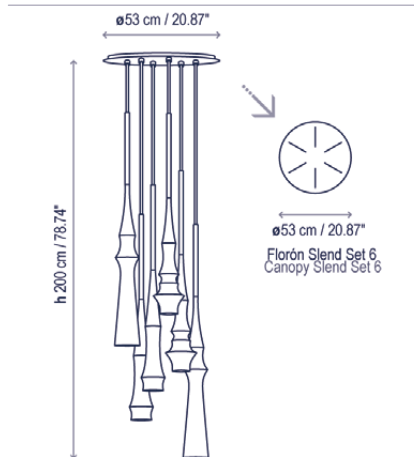

## Descripción técnica / Technical description:

Peso Neto: 11,59 kg  
Net Weight: 11,59 kg

2 Cajas / 2 Boxes:

1 Caja/Box | 53 x 103 x 41 cm | 0,2238 m<sup>3</sup>  
Peso bruto / Gross Weight: 17 kg

1 Caja/Box | 56 x 57 x 24 cm | 0,0766 m<sup>3</sup>  
Peso bruto / Gross Weight: 8,6 kg

Materiales: Aluminio, Hierro  
Materials: Aluminum, Iron

Pantalla realizada de una pieza de aluminio macizo. La abertura de la pantalla que alberga la fuente de luz está revestida de cobre.  
Shade made of a solid aluminum piece. Copper lined aperture houses direct light source.

Las ranuras en el florón permite ajustar la posición de las luminarias durante la instalación.  
Canopy features slots for the cable connection to allow adjustability of the cluster on placement.

Personalizable  
Customizable

Bombillas no incluidas  
Bulbs not included

Certificaciones  
Certifications

## Descripción lámpara / Lamps description:

230V 50Hz IP-20 6 x 6 W GU10 LED

Ref	Acabados / Finishing	Ean13	Euros
2560520000	Blanco Mate - Florón Blanco Matte White - White Canopy	8435493729350	2.167,00
2560520012	Negro Mate - Florón Negro Matte Black - Black Canopy	8435493729367	2.167,00

## Familia / Family: Slend

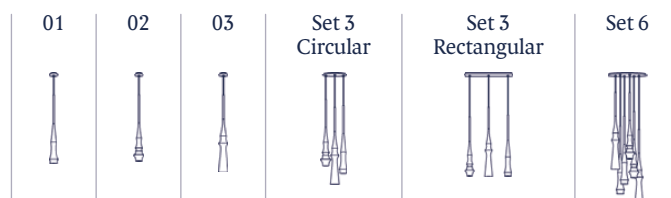

# Spock A

Diseño / Design:  
Christophe Mathieu / 2007

Tipología: Aplique  
Typology: Wall lamp

Ambiente: Interior  
Environment: Indoor

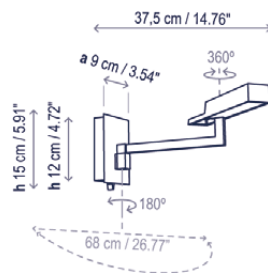

## Descripción técnica / Technical description:

Peso Neto: 1,04 kg  
Net Weight: 1,04 kg

1 Caja/Box | 14 x 47 x 24 cm | 0,0158 m<sup>3</sup>  
Peso bruto / Gross Weight: 1,51 kg

Materiales: Zamac, Hierro, Acero inoxidable 304, Latón.

Materials: Zamac, Iron, 304 Stainless steel, Brass.

Difusor inferior: Policarbonato  
Lower diffuser: Polycarbonate

Caja soporte: 8 x 12 cm  
Surface back box: 3.15" x 4.72"

Personalizable: acabado  
Customizable: finishing

Certificaciones  
Certifications

Recambios / Spare parts:

R10518 Difusor / Diffuser

## Descripción lámpara / Lamps description:

230V 50HZ | IP-20 | 4,8 W LED / CRI: 90 / 3000°K  
420 lm fuente de luz / light source

Ref	Acabados / Finishing	Ean13	Euros
1110506L	Cromo Brillante Brilliant Chrome	8436047305129	381,00
1110511L	Cromo Blanco Chrome White	8436047305112	367,00

Familia / Family: Spock

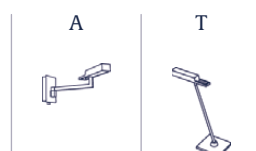



# Spock T

Diseño / Design:  
Christophe Mathieu / 2007

Tipología: Mesa  
Typology: Table lamp

Ambiente: Interior  
Environment: Indoor



Driver Connector

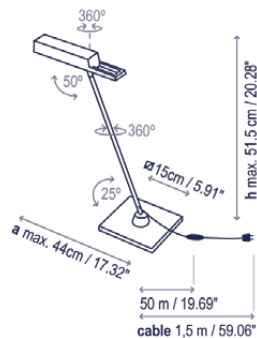

## Descripción técnica / Technical description:

Peso Neto: 2,99 kg  
Net Weight: 2,99 kg

1 Caja/Box | 29 x 21 x 53 cm | 0,0323 m<sup>3</sup>  
Peso bruto / Gross Weight: 3,55 kg

Materiales: Zamac, Hierro, Acero inoxidable 304, Latón.

Materials: Zamac, Iron, 304 Stainless steel, Brass.

Difusor inferior: Policarbonato  
Lower diffuser: Polycarbonate

Personalizable: acabado  
Customizable: finishing

Adaptador para clavijas de tipo A, C, G.  
Adapter for plugs A, C, G type.

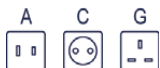

Certificaciones  
Certifications

Recambios / Spare parts:

R10518 Difusor / Diffuser

## Descripción lámpara / Lamps description:

100-240V 50/60Hz IP-20 4,3 W LED / CRI: 90 / 3000°K  
350 lm fuente de luz / light source

Ref	Acabados / Finishing	Ean13	Euros
1910512L	Cromo Chrome	8436047305068	451,00
1910511L	Cromo Blanco Chrome White	8436047305051	416,00

Familia / Family: Spock

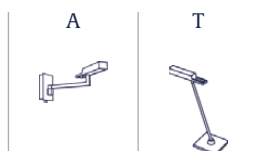

# Syra 45

Diseño / Design:

Alex Fernández Camps | Gonzalo Milà / 2014

Tipología: Suspensión

Typology: Pendant Lamp

Ambiente: Interior

Environment: Indoor

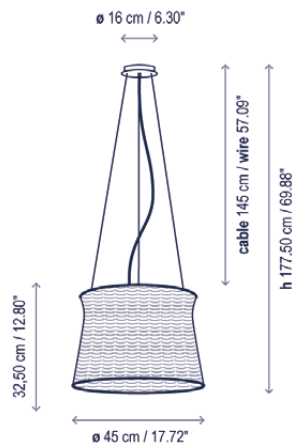

## Descripción técnica / Technical description:

Peso Neto: 5,17 kg  
Net Weight: 5,17 kg

1 Caja/Box | 47 x 47 x 37 cm | 0,0817 m<sup>3</sup>  
Peso bruto / Gross Weight: 6,87 kg

Materiales: Aluminio, Hierro  
Materials: Aluminum, Iron

Difusor inferior: Cristal soplado  
Lower diffuser: Blown crystal

Pantallas tejidas a mano con fibra de polietileno sintética reciclable y no tóxica.  
Hand woven with a recyclable and non-toxic synthetic polyethylene fiber.

No personalizable  
Not customizable

Certificaciones  
Certifications

Recambios / Spare parts:

RDIFSYRA45 Difusor / Diffuser  
R907016 Cable Blanco / White Cable  
R907007 Cable Negro / Black Cable

## Descripción lámpara / Lamps description:

230V 50Hz | IP-20 20,2 W LED / CRI: 90 / 2700°K  
2160 lm fuente de luz / light source

Ref	Acabados / Finishing	Ean13	Euros
26401201100	Estructura Blanco Roto Pantalla Blanco Marfil* Structure Natural White Ivory White Shade*	8436544899688	863,00
26401201101	Estructura Marrón Grafito Pantalla Marrón* Structure Graphite Brown Brown Shade*	8436544899695	863,00
*26401209100	Regulable Sistema DALI Estructura Blanco Roto Pantalla Blanco Marfil* DALI Dimming System Structure Natural White Ivory White Shade*	8436544899701	933,00
*26401209101	Regulable Sistema DALI Estructura Marrón Grafito Pantalla Marrón* DALI Dimming System Structure Graphite Brown Brown Shade*	8436544899718	933,00

\*Por favor, tenga en cuenta que los tonos de color de la pantalla pueden no ser los mismos en todos los casos. / Please note that the shades may have small variations in tone.

Familia / Family: Syra



# Syra 60 Outdoor

Diseño / Design:

Alex Fernández Camps | Gonzalo Milà / 2014

Tipología: Suspensión

Typology: Pendant Lamp

Ambiente: Exterior

Environment: Outdoor

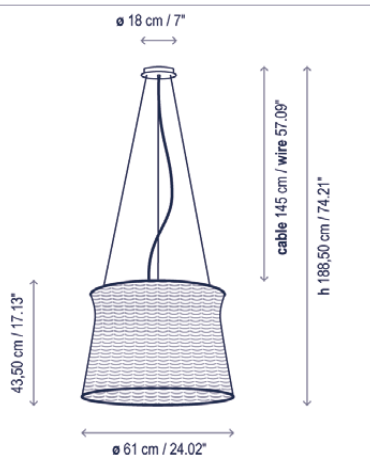

## Descripción técnica / Technical description:

Peso Neto: 8,02 kg  
Net Weight: 8,02 kg

1 Caja/Box | 78 x 78 x 45 cm | 0,2738 m<sup>3</sup>  
Peso bruto / Gross Weight: 11,78 kg

Materiales: Aluminio, Hierro  
Materials: Aluminum, Iron

Difusor inferior: Cristal soplado  
Lower diffuser: Blown crystal

Estructuras de metal acabadas con cataforesis y pintura de poliéster epoxi.  
Metal surfaces coated with cataphoresis and epoxy polyester paint.

Pantallas tejidas a mano con fibra de polietileno sintética reciclable y no tóxica.  
Hand woven with a recyclable and non-toxic synthetic polyethylene fiber.

No personalizable  
Not customizable

Certificaciones  
Certifications

Recambios / Spare parts:

RDIFSYRA60 Difusor / Diffuser  
R907016 Cable Blanco / White Cable  
R907007 Cable Negro / Black Cable

## Descripción lámpara / Lamps description:

230V 50Hz IP-66 23,8 W LED / CRI: 90 / 2700°K 2640 lm fuente de luz / light source

Ref	Acabados / Finishing	Ean13	Euros
26402201100	Estructura Blanco Roto Pantalla Blanco Marfil* Structure Natural White Ivory White Shade*	8436544899725	1.002,00
26402201101	Estructura Marrón Grafito Pantalla Marrón* Structure Graphite Brown Brown Shade*	8436544899732	1.002,00
*26402203100	Regulable Sistema DALI Estructura Blanco Roto Pantalla Blanco Marfil* DALI Dimming System Structure Natural White Ivory White Shade*	8436544899749	1.074,00
*26402203101	Regulable Sistema DALI Estructura Marrón Grafito Pantalla Marrón* DALI Dimming System Structure Graphite Brown Brown Shade*	8436544899756	1.074,00

\*Por favor, tenga en cuenta que los tonos de color de la pantalla pueden no ser los mismos en todos los casos. / Please note that the shades may have small variations in tone.

Nota de uso: Para ambientes con alto grado de salinidad, será necesario realizar un correcto mantenimiento de la luminaria. Recomendamos limpiar con un cepillo suave y retirar la sal, el polvo, o la suciedad depositada por la humedad o el viento.

Note of use: For environments with a high salinity, proper maintenance of the luminaire will be necessary. We recommend cleaning it with a soft brush and remove salt, dust, or dirt deposited by moisture or wind.

Familia / Family: Syra



# Syra 90 Outdoor

Diseño / Design:

Alex Fernández Camps | Gonzalo Milà / 2014

Tipología: Suspensión

Typology: Pendant Lamp

Ambiente: Exterior

Environment: Outdoor

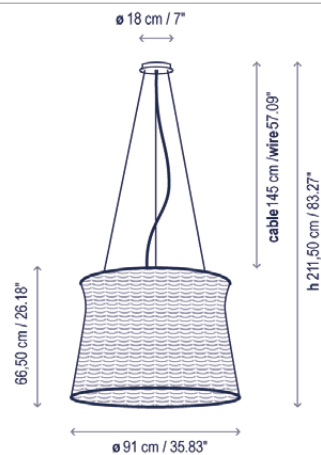

## Descripción técnica / Technical description:

Peso Neto: 12,18 kg  
Net Weight: 12,18 kg

1 Caja/Box | 106 x 97 x 75 cm | 0,7712 m<sup>3</sup>  
Peso bruto / Gross Weight: 17,18 kg

Materiales: Aluminio, Hierro  
Materials: Aluminum, Iron

Difusor inferior: Cristal soplado  
Lower diffuser: Blown crystal

Estructuras de metal acabadas con cataforesis y pintura de poliéster epoxi.  
Metal surfaces coated with cataphoresis and epoxy polyester paint.

Pantallas tejidas a mano con fibra de polietileno sintética reciclable y no tóxica.  
Hand woven with a recyclable and non-toxic synthetic polyethylene fiber.

No personalizable  
Not customizable

Certificaciones  
Certifications

Recambios / Spare parts:

RDIFSYRA90 Difusor / Diffuser  
R907016 Cable Blanco / White Cable  
R907007 Cable Negro / Black Cable

## Descripción lámpara / Lamps description:

230V 50Hz IP-66 28 W LED / CRI: 90 / 2700°K 3360 lm fuente de luz / light source

Ref	Acabados / Finishing	Ean13	Euros
26403201100	Estructura Blanco Roto Pantalla Blanco Marfil* Structure Natural White Ivory White Shade*	8436544899763	1.392,00
26403201101	Estructura Marrón Grafito Pantalla Marrón* Structure Graphite Brown Brown Shade*	8436544899770	1.392,00
*26403203100	Regulable Sistema DALI Estructura Blanco Roto Pantalla Blanco Marfil* DALI Dimming System Structure Natural White Ivory White Shade*	8436544899787	1.429,00
*26403203101	Regulable Sistema DALI Estructura Marrón Grafito Pantalla Marrón* DALI Dimming System Structure Graphite Brown Brown Shade*	8436544899794	1.429,00

\*Por favor, tenga en cuenta que los tonos de color de la pantalla pueden no ser los mismos en todos los casos. / Please note that the shades may have small variations in tone.

Nota de uso: Para ambientes con alto grado de salinidad, será necesario realizar un correcto mantenimiento de la luminaria. Recomendamos limpiar con un cepillo suave y retirar la sal, el polvo, o la suciedad depositada por la humedad o el viento.

Note of use: For environments with a high salinity, proper maintenance of the luminaire will be necessary. We recommend cleaning it with a soft brush and remove salt, dust, or dirt deposited by moisture or wind.

Familia / Family: Syra



# Tanit M/29/R

Diseño / Design:  
Gonzalo Milà / 2019

Tipología: Mesa  
Typology: Table lamp

Ambiente: Interior  
Environment: Indoor

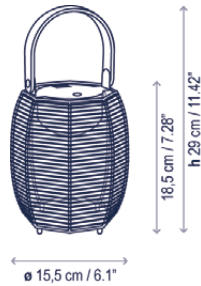

## Descripción técnica / Technical description:

Peso Neto Unidad: 0,58 kg  
Net Weight Unit: 0,58 kg

1 Caja/Box | 29 x 24 x 22 cm | 0,0153 m<sup>3</sup>  
Peso bruto / Gross Weight: 1,31 kg

Materiales: Hierro, Hilo de algodón, Silicona  
Materials: Iron, Cotton, Silicone

Interruptor On-Off.  
3 posiciones de encendido: 25% 50% 100%.  
Tiempo de carga: +/- 5 horas.  
Duración batería al 100%: +/- 5 horas.  
Duración batería al 50%: +/- 10 horas.  
Duración batería al 25%: +/- 20 horas.  
Cargador batería incluido (100-240V 50/60Hz).

On-Off Switch.  
3 lighting power: 25% 50% 100%.  
Battery charging time: +/- 5 hours.  
Battery duration time at 100%: +/- 5 hours.  
Battery duration time at 50%: +/- 10 hours.  
Battery duration time at 25%: +/- 20 hours.  
Battery charger included (100-240V 50/60Hz).

Fuente de luz protegida por difusor de policarbonato.  
Light source protected by polycarbonate diffuser.

Adaptador para clavijas de tipo A, C, G.  
Adapter for plugs A, C, G type.



USB: 5Vdc 1,5A

No personalizable  
Not customizable

Certificaciones  
Certifications

## Descripción lámpara / Lamps description:

5Vdc 1,5A | IP-20 | 1,5 W LED / CRI: 80 / 2700°K  
54 lm fuente de luz / light source

Ref	Acabados / Finishing	Ean13	Euros
26101317119	Pantalla Beige 2 Asas de Silicona: Terracotta y Marrón Chocolate Beige Shade 2 Silicone Handles: Terracotta and Chocolate Brown	8435493724669	161,00

Pedido mínimo: caja de 6 unidades / Minimum order: box of 6 units

1 Caja de 6 uds. / 1 Box/6units | 55 x 37 x 26 cm | 0,0529 m<sup>3</sup>  
Peso bruto / Gross Weight: 6,10 kg

# Tibeta 01

Diseño / Design:  
Christophe Mathieu / 2015

Tipología: Suspensión  
Typology: Pendant Lamp

Ambiente: Interior  
Environment: Indoor

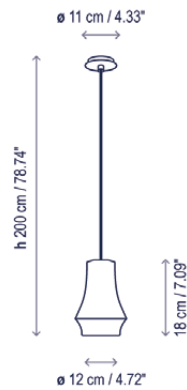

## Descripción técnica / Technical description:

Peso Neto: 2,33 kg  
Net Weight: 2,33 kg

1 Caja/Box | 24 x 22 x 22 cm | 0,0116 m<sup>3</sup>  
Peso bruto / Gross Weight: 2,61 kg

Materiales: Aluminio, Hierro  
Materials: Aluminum, Iron

Difusor: Metacrilato  
Diffuser: Methacrylate

Acabado mate bajo pedido sin alteración de precio. Otros acabados consultar.  
Matte finish upon request without price alteration. For other finishes, consult.

Consulte la tabla de reguladores TRIAC recomendados en la página 212.  
Please check the list of recommended TRIAC dimmers at page 212.

Personalizable: acabado  
Customizable: finishing

Certificaciones  
Certifications

Recambios / Spare parts:

R907024 Cable Textil / Fabric Cable  
R907022 Cable Metálico / Metal Mesh Cable

## Descripción lámpara / Lamps description:

230V 50Hz | IP-20 | TRIAC | 8,7 W LED / CRI: 80 / 2900<sup>o</sup>-3200<sup>o</sup>K | 610 lm fuente de luz / light source

Ref	Acabados / Finishing	Ean13	Euros
2570120107	Cromo Negro - Cable Textil Negro Black Chrome - Black Fabric Cable	8436535531085	375,00
2570120190	Cobre Brillo - Cable Metálico Color Cobre Brilliant Copper - Copper Metal Mesh Cable	8436535531092	383,00
2570120179	Latón Envejecido - Cable Textil Negro Antique Brass - Black Fabric Cable	8436544896175	410,00

Familia / Family: Tibeta

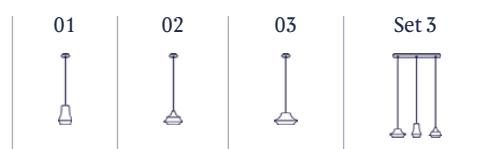



# Tibeta 02

Diseño / Design:  
Christophe Mathieu / 2015

Tipología: Suspensión  
Typology: Pendant Lamp

Ambiente: Interior  
Environment: Indoor

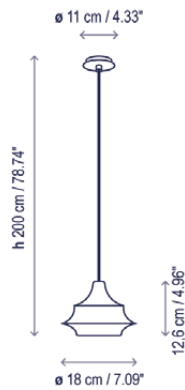

## Descripción técnica / Technical description:

Peso Neto: 2,33 kg  
Net Weight: 2,33 kg

1 Caja/Box | 24 x 22 x 22 cm | 0,0116 m<sup>3</sup>  
Peso bruto / Gross Weight: 2,84 kg

Materiales: Aluminio, Hierro  
Materials: Aluminum, Iron

Difusor: Metacrilato  
Diffuser: Methacrylate

Acabado mate bajo pedido sin alteración de precio. Otros acabados consultar.  
Matte finish upon request without price alteration. For other finishes, consult.

Consulte la tabla de reguladores TRIAC recomendados en la página 212.  
Please check the list of recommended TRIAC dimmers at page 212.

Personalizable: acabado  
Customizable: finishing

Certificaciones  
Certifications

Recambios / Spare parts:

R907024 Cable Textil / Fabric Cable  
R907022 Cable Metálico / Metal Mesh Cable

## Descripción lámpara / Lamps description:

230V 50Hz | IP-20 | TRIAC | 8,7 W LED / CRI: 80 / 2900<sup>o</sup>-3200<sup>o</sup>K | 610 lm fuente de luz / light source

Ref	Acabados / Finishing	Ean13	Euros
2570220107	Cromo Negro - Cable Textil Negro Black Chrome - Black Fabric Cable	8436535531122	405,00
2570220190	Cobre Brillo - Cable Metálico Color Cobre Brilliant Copper - Copper Metal Mesh Cable	8436535531146	419,00
2570220179	Latón Envejecido - Cable Textil Negro Antique Brass - Black Fabric Cable	8436544896199	449,00

Familia / Family: Tibeta

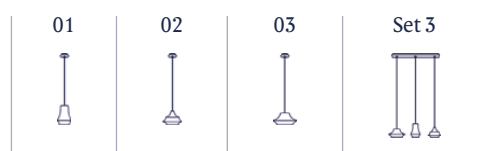

# Tibeta 03

Diseño / Design:  
Christophe Mathieu / 2015

Tipología: Suspensión  
Typology: Pendant Lamp

Ambiente: Interior  
Environment: Indoor

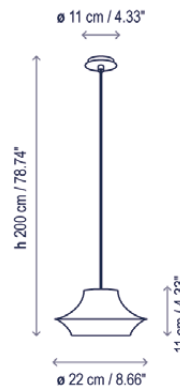

## Descripción técnica / Technical description:

Peso Neto: 3,33 kg  
Net Weight: 3,33 kg

1 Caja/Box | 29 x 29 x 22 cm | 0,0185 m<sup>3</sup>  
Peso bruto / Gross Weight: 3,75 kg

Materiales: Aluminio, Hierro  
Materials: Aluminum, Iron

Difusor: Metacrilato  
Diffuser: Methacrylate

Acabado mate bajo pedido sin alteración de precio. Otros acabados consultar.  
Matte finish upon request without price alteration. For other finishes, consult.

Consulte la tabla de reguladores TRIAC recomendados en la página 212.  
Please check the list of recommended TRIAC dimmers at page 212.

Personalizable: acabado  
Customizable: finishing

Certificaciones  
Certifications

Recambios / Spare parts:

R907024 Cable Textil / Fabric Cable  
R907022 Cable Metálico / Metal Mesh Cable

## Descripción lámpara / Lamps description:

230V 50Hz | IP-20 | TRIAC | 15 W LED / CRI: 80 / 2900<sup>2</sup>-5200<sup>2</sup>K | 955 lm fuente de luz / light source

Ref	Acabados / Finishing	Ean13	Euros
2570320107	Cromo Negro - Cable Textil Negro Black Chrome - Black Fabric Cable	8436535531269	465,00
2570320190	Cobre Brillo - Cable Metálico Color Cobre Brilliant Copper - Copper Metal Mesh Cable	8436535531283	474,00
2570320179	Latón Envejecido - Cable Textil Negro Antique Brass - Black Fabric Cable	8436544896212	507,00

Familia / Family: Tibeta

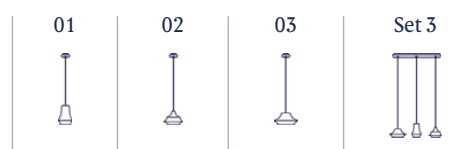

# Tibeta Set 3

Diseño / Design:  
Christophe Mathieu / 2015

Tipología: Suspensión  
Typology: Pendant Lamp

Ambiente: Interior  
Environment: Indoor

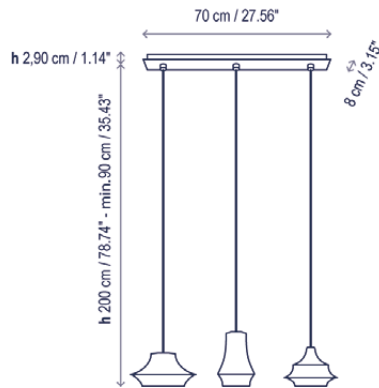

## Descripción técnica / Technical description:

Peso Neto: 11,4 kg  
Net Weight: 11,4 kg

1 Caja/Box | 31 x 108 x 31 cm | 0,1038 m<sup>3</sup>  
Peso bruto / Gross Weight: 15,26 kg

Materiales: Aluminio, Hierro  
Materials: Aluminum, Iron

Acabado mate bajo pedido sin alteración de precio. Otros acabados consultar.  
Matte finish upon request without price alteration. For other finishes, consult.

Personalizable: acabado  
Customizable: finishing

Certificaciones  
Certifications

Recambios / Spare parts:

R907024 Cable Textil / Fabric Cable  
R907022 Cable Metálico / Metal Mesh Cable

## Descripción lámpara / Lamps description:

230V 50Hz | IP-20 | TRIAC | 30,4 W LED / CRI: 80 / 2900<sup>a</sup>-3200<sup>a</sup>K | 2155 lm fuente de luz / light source

Ref	Acabados / Finishing	Ean13	Euros
2570420107	Cromo Negro - Cable Textil Negro Black Chrome - Black Fabric Cable	8436535531412	1.300,00
2570420190	Cobre Brillo - Cable Metálico Color Cobre Brilliant Copper - Copper Metal Mesh Cable	8436535531436	1.341,00
2570420179	Latón Envejecido - Cable Textil Negro Antique Brass - Black Fabric Cable	8436544896304	1.353,00

Familia / Family: Tibeta

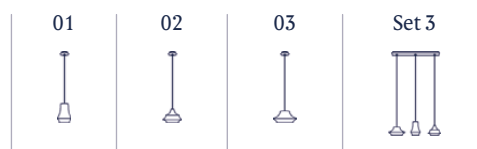

# Tria 01

Diseño / Design:  
Ruben Saldaña / 2015

Tipología: Aplique  
Typology: Wall Lamp

Ambiente: Interior  
Environment: Indoor

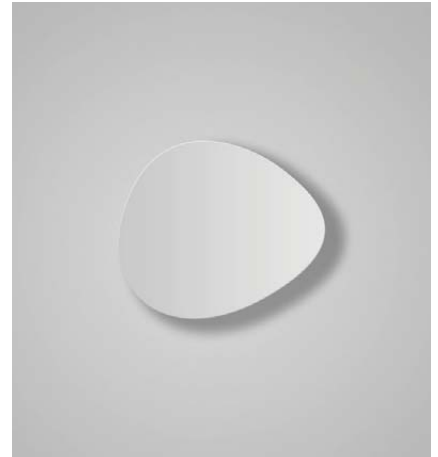
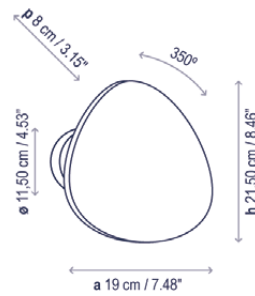

## Descripción técnica / Technical description:

Peso Neto: 0,79 kg  
Net Weight: 0,79 kg

1 Caja/Box | 24 x 22 x 22 cm | 0,0116 m<sup>3</sup>  
Peso bruto / Gross Weight: 1,04 kg

Materiales: Madera acabado roble, Aluminio  
Materials: Wood finished oak, Aluminum

Frontal orientable  
Adjustable frontal

Caja soporte: ø 9,5 cm  
Surface back box: ø 3.74"

Consulte la tabla de reguladores TRIAC recomendados en la página 212.  
Please check the list of recommended TRIAC dimmers at page 212.

Personalizable: consultar  
Customizable: consult

Certificaciones  
Certifications

## Descripción lámpara / Lamps description:

230V 50Hz | IP-20 | 8,7 W LED / CRI: 90 / 2700°K | 960 lm fuente de luz / light source

Ref	Acabados / Finishing	Ean13	Euros
2080100601	Blanco Lacado Satinado White Satin Lacquer	8436535533294	190,00
2080100635	Roble Natural Natural Oak	8436535533386	210,00
*2080101301	Regulable Triac - Blanco Lacado Satinado Dimmable Triac - White Satin Lacquer	8435493714943	199,00
*2080101335	Regulable Triac - Roble Natural Dimmable Triac - Natural Oak	8435493723280	219,00

Familia / Family: Tria

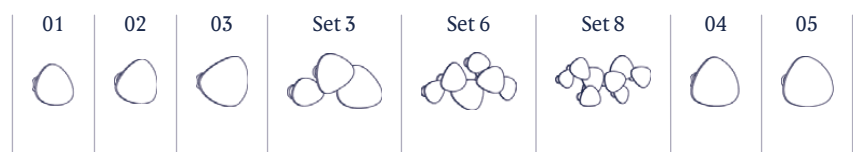

# Tria 02

Diseño / Design:  
Ruben Saldaña / 2015

Tipología: Aplique  
Typology: Wall Lamp

Ambiente: Interior  
Environment: Indoor

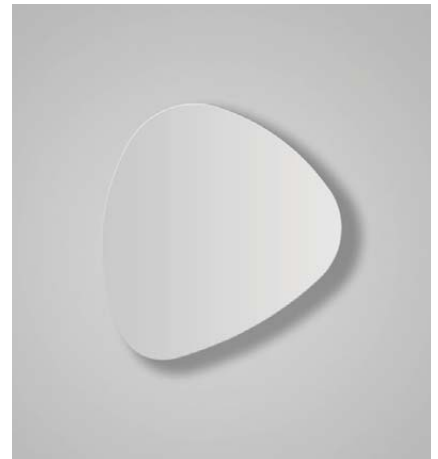
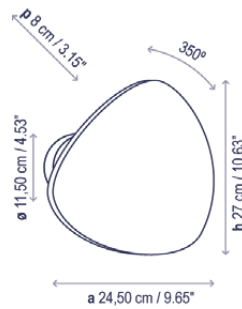

## Descripción técnica / Technical description:

Peso Neto: 1,08 kg  
Net Weight: 1,08 kg

1 Caja/Box | 29 x 29 x 22 cm | 0,0185 m<sup>3</sup>  
Peso bruto / Gross Weight: 1,62 kg

Materiales: Madera acabado roble, Aluminio  
Materials: Wood finished oak, Aluminum

Frontal orientable  
Adjustable frontal

Caja soporte: ø 9,5 cm  
Surface back box: ø 3.74"

Consulte la tabla de reguladores TRIAC recomendados en la página 212.  
Please check the list of recommended TRIAC dimmers at page 212.

Personalizable: consultar  
Customizable: consult

Certificaciones  
Certifications

## Descripción lámpara / Lamps description:

230V 50HZ IP-20 13 W LED / CRI: 90 / 2700°K 1440 lm fuente de luz / light source

Ref	Acabados / Finishing	Ean13	Euros
2080200601	Blanco Lacado Satinado White Satin Lacquer	8436535533409	245,00
2080200635	Roble Natural Natural Oak	8436535534208	262,00
*2080201301	Regulable Triac - Blanco Lacado Satinado Dimmable Triac - White Satin Lacquer	8436544891439	254,00
*2080201335	Regulable Triac - Roble Natural Dimmable Triac - Natural Oak	8436544891446	278,00

## Familia / Family: Tria

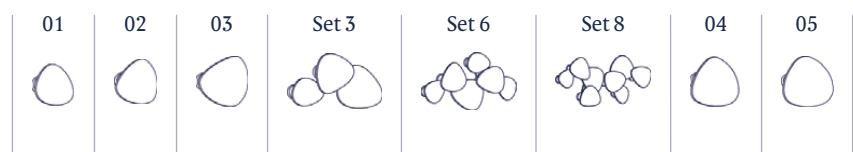

Interior / Indoor

Exterior / Outdoor

# Tria 03

Diseño / Design:  
Ruben Saldaña / 2015

Tipología: Aplique  
Typology: Wall Lamp

Ambiente: Interior  
Environment: Indoor

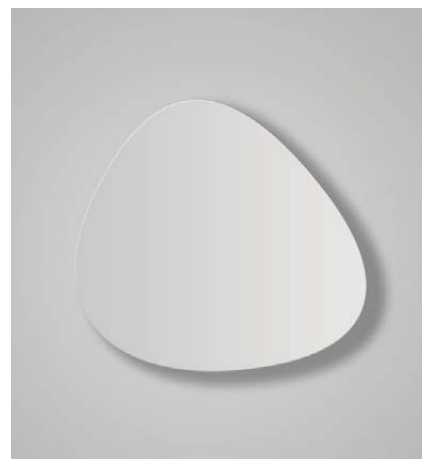
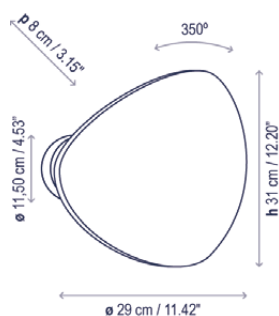

## Descripción técnica / Technical description:

Peso Neto: 1,34 kg  
Net Weight: 1,34 kg

1 Caja/Box | 45 x 11 x 45 cm | 0,0223 m<sup>3</sup>  
Peso bruto / Gross Weight: 1,72 kg

Materiales: Madera acabado roble, Aluminio  
Materials: Wood finished oak, Aluminum

Frontal orientable  
Adjustable frontal

Caja soporte: ø 9,5 cm  
Surface back box: ø 3.74"

Consulte la tabla de reguladores TRIAC recomendados en la página 212.  
Please check the list of recommended TRIAC dimmers at page 212.

Personalizable: consultar  
Customizable: consult

Certificaciones  
Certifications

## Descripción lámpara / Lamps description:

230V 50Hz IP-20 17 W LED / CRI: 90 / 2700°K 1920 lm fuente de luz / light source

Ref	Acabados / Finishing	Ean13	Euros
2080300601	Blanco Lacado Satinado White Satin Lacquer	8436535534482	284,00
2080300635	Roble Natural Natural Oak	8436535534505	314,00
*2080301401	Regulable Triac - Blanco Lacado Satinado Dimmable Triac - White Satin Lacquer	8436544891606	301,00
*2080301435	Regulable Triac - Roble Natural Dimmable Triac - Natural Oak	8436544891620	323,00

Familia / Family: Tria





# Tria Set 3

Diseño / Design:  
Ruben Saldaña / 2015

Tipología: Aplique  
Typology: Wall Lamp

Ambiente: Interior  
Environment: Indoor

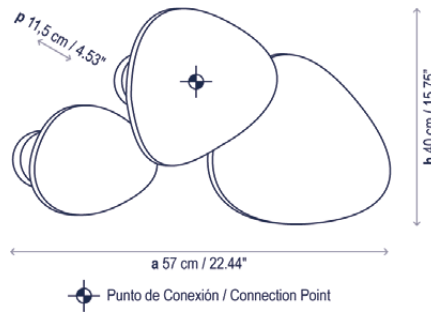

## Descripción técnica / Technical description:

Peso Neto: 3,2 kg  
Net Weight: 3,2 kg

1 Caja/Box | 47 x 47 x 37 cm | 0,0817 m<sup>3</sup>  
Peso bruto / Gross Weight: 5,33 kg

Materiales: Madera acabado roble, Aluminio  
Materials: Wood finished oak, Aluminum

Frontal orientable. 1 punto de conexión.  
Adjustable frontal. 1 Connection point.

Caja soporte: ø 9,5 cm  
Surface back box: ø 3.74"

Consulte la tabla de reguladores TRIAC recomendados en la página 212.  
Please check the list of recommended TRIAC dimmers at page 212.

Personalizable: consultar  
Customizable: consult

Certificaciones  
Certifications

## Descripción lámpara / Lamps description:

230V 50Hz | IP-20 39 W LED / CRI: 90 / 2700°K  
4320 lm fuente de luz / light source

Ref	Acabados / Finishing	Ean13	Euros
2081300601	Blanco Lacado Satinado White Satin Lacquer	8436535534758	739,00
2081300635	Roble Natural Natural Oak	8436535534796	821,00
2081300619	Blanco - Roble Natural - Blanco White Satin - Natural Oak - White Satin	8435493718774	766,00
*2081301301	Regulable Triac Blanco Lacado Satinado Dimmable Triac White Satin Lacquer	8436544891637	766,00
*2081301335	Regulable Triac Roble Natural Dimmable Triac Natural Oak	8436544891644	847,00
*2081301319	Regulable Triac Blanco - Roble Natural - Blanco Dimmable Triac White Satin - Natural Oak - White Satin	8435493718880	793,00

## Familia / Family: Tria

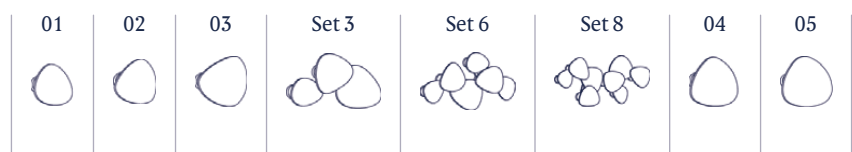

Interior / Indoor

Exterior / Outdoor

# Tria Set 6

Diseño / Design:  
Ruben Saldaña / 2015

Tipología: Aplique  
Typology: Wall Lamp

Ambiente: Interior  
Environment: Indoor

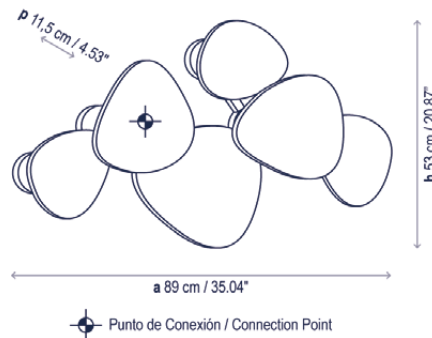

## Descripción técnica / Technical description:

Peso Neto: 6,8 kg  
Net Weight: 6,8 kg

1 Caja/Box | 53 x 103 x 41 cm | 0,2238 m<sup>3</sup>  
Peso bruto / Gross Weight: 10,78 kg

Materiales: Madera acabado roble, Aluminio  
Materials: Wood finished oak, Aluminum

Frontal orientable. 1 punto de conexión.  
Adjustable frontal. 1 Connection point.

Caja soporte: ø 9,5 cm  
Surface back box: ø 3.74"

Consulte la tabla de reguladores TRIAC recomendados en la página 212.  
Please check the list of recommended TRIAC dimmers at page 212.

Personalizable: consultar  
Customizable: consult

Certificaciones  
Certifications

## Descripción lámpara / Lamps description:

230V 50Hz | IP-20 | TRIAC\* | 69 W LED / CRI: 90 / 2700°K | 7080 lm fuente de luz / light source

Ref	Acabados / Finishing	Ean13	Euros
2081600601	Blanco Lacado Satinado White Satin Lacquer	8436535534819	1.379,00
2081600635	Roble Natural Natural Oak	8436535534833	1.531,00
*2081601301	Regulable Triac - Blanco Lacado Satinado Dimmable Triac - White Satin Lacquer	8436544891651	1.455,00
*2081601335	Regulable Triac - Roble Natural Dimmable Triac - Natural Oak	8436544891682	1.606,00

Familia / Family: Tria

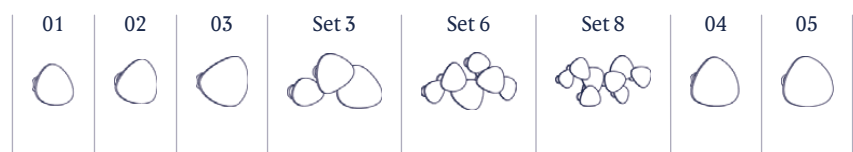

# Tria Set 8

Diseño / Design:  
Ruben Saldaña / 2015

Tipología: Aplique  
Typology: Wall Lamp

Ambiente: Interior  
Environment: Indoor

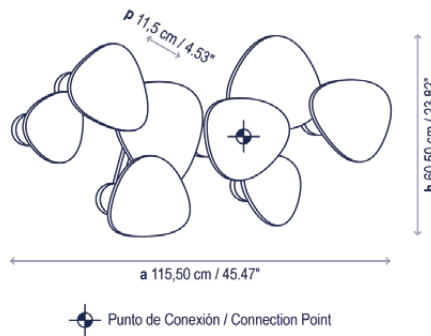

## Descripción técnica / Technical description:

Peso Neto: 8,74 kg  
Net Weight: 8,74kg

1 Caja/Box | 53 x 103 x 41 cm | 0,2238 m<sup>3</sup>  
Peso bruto / Gross Weight: 13,05 kg

Materiales: Madera acabado roble, Aluminio  
Materials: Wood finished oak, Aluminum

Frontal orientable. 1 punto de conexión.  
Adjustable frontal. 1 Connection point.

Caja soporte: ø 9,5 cm  
Surface back box: ø 3.74"

Consulte la tabla de reguladores TRIAC recomendados en la página 212.  
Please check the list of recommended TRIAC dimmers at page 212.

Personalizable: consultar  
Customizable: consult

Certificaciones  
Certifications

## Descripción lámpara / Lamps description:

230V 50Hz | IP-20 103,2 W LED / CRI: 90 / 2700°K  
11520 lm fuente de luz / light source

Ref	Acabados / Finishing	Ean13	Euros
2081800601	Blanco Lacado Satinado White Satin Lacquer	8436535534857	2.003,00
2081800635	Roble Natural Natural Oak	8436535534970	2.219,00
*2081801301	Regulable Triac - Blanco Lacado Satinado Dimmable Triac - White Satin Lacquer	8436544891699	2.089,00
*2081801335	Regulable Triac - Roble Natural Dimmable Triac - Natural Oak	8436544891712	2.305,00

## Familia / Family: Tria

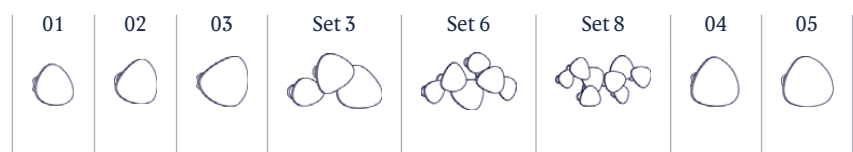

Interior / Indoor

Exterior / Outdoor

# Tria 04 Outdoor

Diseño / Design:  
Ruben Saldaña / 2015

Tipología: Aplique  
Typology: Wall Lamp

Ambiente: Exterior  
Environment: Outdoor

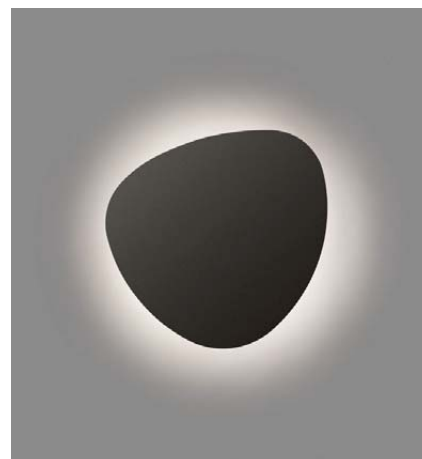
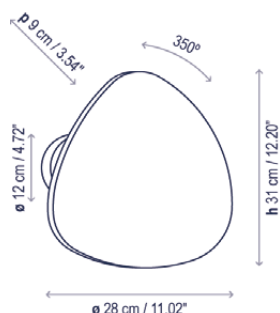

## Descripción técnica / Technical description:

Peso Neto: 2,88 kg  
Net Weight: 2,88 kg

1 Caja/Box | 45 x 45 x 11 cm | 0,0223 m<sup>3</sup>  
Peso bruto / Gross Weight: 3,2 kg

Materiales: Aluminio o Madera de teka  
Materials: Aluminum or Teka wood

Frontal orientable  
Adjustable frontal

Caja soporte: ø 12 cm  
Surface back box: ø 4.72"

Consulte la tabla de reguladores TRIAC recomendados en la página 212.  
Please check the list of recommended TRIAC dimmers at page 212.

Personalizable: acabado  
Customizable: finishing

Certificaciones  
Certifications

## Descripción lámpara / Lamps description:

230V 50HZ IP-66 11,5 W LED / CRI: 90 / 2700°K  
1346 lm fuente de luz / light source

Ref	Acabados / Finishing	Ean13	Euros
*2080401214	Regulable Triac - Frontal Metal Marrón Grafito Dimmable Triac - Graphite Brown Metal Frontal	8435493723488	385,00
2080401229	Regulable Triac - Frontal Madera Teca Dimmable Triac - Teak Wood Frontal	8435493723495	385,00

Familia / Family: Tria



# Tria 05 Outdoor

Diseño / Design:  
Ruben Saldaña / 2015

Tipología: Aplique  
Typology: Wall Lamp

Ambiente: Exterior  
Environment: Outdoor

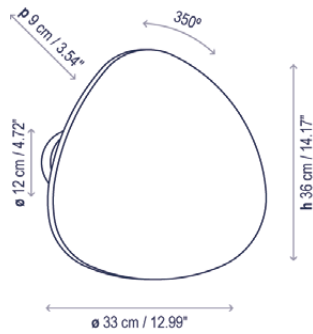

## Descripción técnica / Technical description:

Peso Neto: 5 kg  
Net Weight: 5 kg

1 Caja/Box | 45 x 45 x 11 cm | 0,0223 m<sup>3</sup>  
Peso bruto / Gross Weight: 6,3 kg

Materiales: Aluminio o Madera de teka  
Materials: Aluminum or Teka wood

Frontal orientable  
Adjustable frontal

Caja soporte: ø 12 cm  
Surface back box: ø 4.72"

Consulte la tabla de reguladores TRIAC recomendados en la página 212.  
Please check the list of recommended TRIAC dimmers at page 212.

Personalizable: acabado  
Customizable: finishing

Certificaciones  
Certifications

## Descripción lámpara / Lamps description:

230V 50Hz | IP-66 | 11,5 W LED / CRI: 90 / 2700°K | 1346 lm fuente de luz / light source

Ref	Acabados / Finishing	Ean13	Euros
*2080501214	Regulable Triac - Frontal Metal Marrón Grafito Dimmable Triac - Graphite Brown Metal Frontal	8435493723518	427,00
2080501229	Regulable Triac - Frontal Madera Teca Dimmable Triac - Teak Wood Frontal	8435493723501	427,00

Familia / Family: Tria

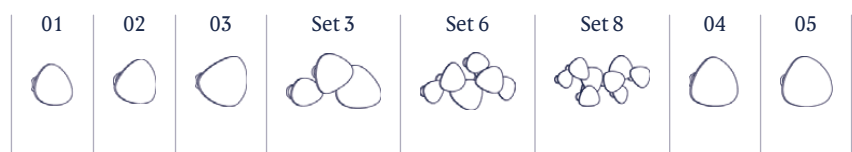

Interior / Indoor

Exterior / Outdoor

# Twall LED

Diseño / Design:  
Christophe Mathieu / 2004

Tipología: Aplique  
Typology: Wall Lamp

Ambiente: Interior  
Environment: Indoor

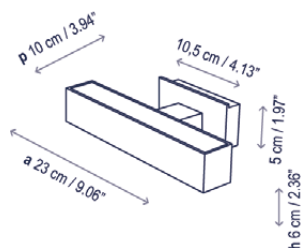

## Descripción técnica / Technical description:

 Peso Neto: 1,11 kg  
Net Weight: 1,11 kg

 1 Caja/Box | 36 x 14 x 13 cm | 0,0066 m<sup>3</sup>  
Peso bruto / Gross Weight: 1,38 kg

Materiales: Acero inoxidable 304  
Materials: 304 stainless steel

Difusor superior e inferior: Cristal templado  
Upper and lower diffusers: Tempered glass

Caja soporte: 10,5 x 5 cm  
Surface back box: 4.13" x 1.97"

Consulte la tabla de reguladores TRIAC recomendados en la página 212.  
Please check the list of recommended TRIAC dimmers at page 212.

No personalizable  
Not customizable

Certificaciones  
Certifications



## Descripción lámpara / Lamps description:

  230V 50HZ | IP-20 |  TRIAC |  8,2 W LED / CRI: 90 / 2700<sup>o</sup>K | 840 lm fuente de luz / light source

Ref	Acabados / Finishing	Ean13	Euros
1970101305	Regulable Triac - Níquel Satinado Dimmable Triac - Satin Nickel	8436544891767	437,00
1970101306	Regulable Triac - Cromo Brillante Dimmable Triac - Brilliant Chrome	8436544891774	427,00
1970101365	Regulable Triac - Blanco Dimmable Triac - White	8436544891781	410,00



# Urban PF/37

Diseño / Design:  
Joana Bover / 2011

Tipología: Plafón  
Typology: Ceiling lamp

Ambiente: Interior  
Environment: Indoor

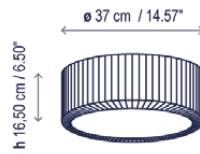

## Descripción técnica / Technical description:

Peso Neto: 2,66 kg  
Net Weight: 2,66 kg

1 Caja/Box | 40 x 40 x 25 cm | 0,04 m<sup>3</sup>  
Peso bruto / Gross Weight: 3,32 kg

Materiales: Hierro  
Materials: Iron

Difusor inferior: Metacrilato  
Lower diffuser: Methacrylate

Hilo incandescente pantalla: 960°  
Shade GWFI: 960°

Personalizable  
Customizable

Bombillas no incluidas  
Bulbs not included

Certificaciones  
Certifications

Recambios / Spare parts:

R01325DIF Difusor + Aro / Diffuser + Ring

## Descripción lámpara / Lamps description:

230V 50Hz | IP-20 | 2 x 46 W EcoClassic P45 E-27 | 2 x 22 W CFL E-27 | 2 x 6 W LED P45 E-27

Ref	Acabados / Finishing	Ean13	Euros
0132506B	Pantalla Cinta Translúcida Blanca White Translucent Ribbon Shade	8436544890760	386,00
0132506C	Pantalla Cinta Translúcida Crema Cream Translucent Ribbon Shade	8436544890739	386,00

## Familia / Family: Urban

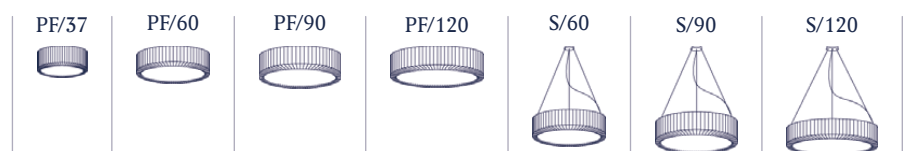

# Urban PF/60

Diseño / Design:  
Joana Bover / 2011

Tipología: Plafón  
Typology: Ceiling lamp

Ambiente: Interior  
Environment: Indoor

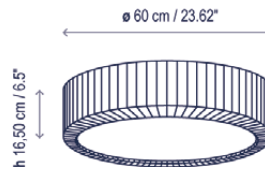

## Descripción técnica / Technical description:

Peso Neto: 6,27 kg  
Net Weight: 6,27 kg

1 Caja/Box | 67 x 67 x 25 cm | 0,1122 m<sup>3</sup>  
Peso bruto / Gross Weight: 8,22 kg

Materiales: Hierro  
Materials: Iron

Difusor inferior: Metacrilato  
Lower diffuser: Methacrylate

Hilo incandescente pantalla: 960°  
Shade GWFI: 960°

Personalizable  
Customizable

Bombillas no incluidas  
Bulbs not included

Certificaciones  
Certifications

Recambios / Spare parts:

R02325DIF Difusor + Aro / Diffuser + Ring

## Descripción lámpara / Lamps description:

230V 50Hz | IP-20 | 4 x 46 W EcoClassic P45 E-27 | 4 x 22 W CFL E-27 | 4 x 6 W LED P45 E-27

Ref	Acabados / Finishing	Ean13	Euros
0232506B	Pantalla Cinta Translúcida Blanca White Translucent Ribbon Shade	8436544890777	562,00
0232506C	Pantalla Cinta Translúcida Crema Cream Translucent Ribbon Shade	8436544890784	562,00

## Descripción lámpara / Lamps description:

120-277V 50/60Hz | IP-20 | 34 W LED / CRI: 90 / 2700°K  
2686 lm fuente de luz / light source

Ref	Acabados / Finishing	Ean13	Euros
710232506B	LED dimable TRIAC Pantalla Cinta Translúcida Blanca LED TRIAC Dimmable White Translucent Ribbon Shade	8436047301923	696,00
710232506C	LED dimable TRIAC Pantalla Cinta Translúcida Crema LED TRIAC Dimmable Cream Translucent Ribbon Shade	8436544895864	696,00

## Familia / Family: Urban

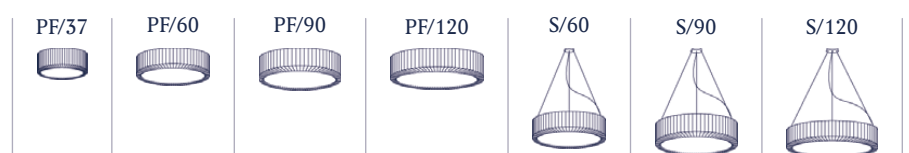

# Urban PF/90

Diseño / Design:  
Joana Bover / 2011

Tipología: Plafón  
Typology: Ceiling lamp

Ambiente: Interior  
Environment: Indoor

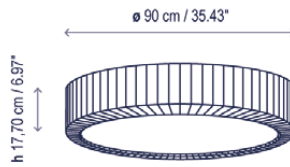

## Descripción técnica / Technical description:

Peso Neto: 11,6 kg  
Net Weight: 11,6 kg

1 Caja/Box | 91 x 92 x 26 cm | 0,2177 m<sup>3</sup>  
Peso bruto / Gross Weight: 18,46 kg

Materiales: Hierro  
Materials: Iron

Difusor inferior: Metacrilato  
Lower diffuser: Methacrylate

Hilo incandescente pantalla: 960°  
Shade GWFI: 960°

Personalizable  
Customizable

Bombillas no incluidas  
Bulbs not included

Certificaciones  
Certifications

Recambios / Spare parts:

R04325DIF Difusor / Diffuser

## Descripción lámpara / Lamps description:

230V 50Hz | IP-20 | 4 x 24 W 2G11

Ref	Acabados / Finishing	Ean13	Euros
0432506B	Pantalla Cinta Translúcida Blanca White Translucent Ribbon Shade	8436544895819	1.562,00
0432506C	Pantalla Cinta Translúcida Crema Cream Translucent Ribbon Shade	8436544893648	1.562,00
*D0432506B	Regulable Sistema DALI Pantalla Cinta Translúcida Blanca DALI Dimming System White Translucent Ribbon Shade	8436544894881	1.717,00
*D0432506C	Regulable Sistema DALI Pantalla Cinta Translúcida Crema DALI Dimming System Cream Translucent Ribbon Shade	8436544894867	1.717,00

## Familia / Family: Urban

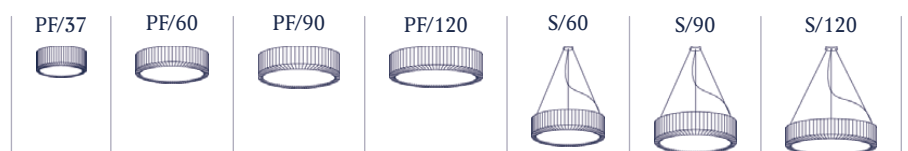

# Urban PF/120

Diseño / Design:  
Joana Bover / 2011

Tipología: Plafón  
Typology: Ceiling lamp

Ambiente: Interior  
Environment: Indoor

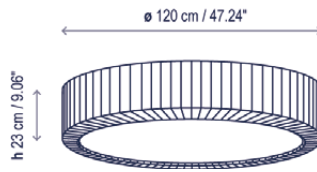

## Descripción técnica / Technical description:

Peso Neto: 19,7 kg  
Net Weight: 19,7 kg

1 Caja/Box | 127 x 128 x 45 cm | 0,7315 m<sup>3</sup>  
Peso bruto / Gross Weight: 34,26 kg

Materiales: Hierro  
Materials: Iron

Difusor inferior: Metacrilato  
Lower diffuser: Methacrylate

Hilo incandescente pantalla: 960°  
Shade GWFI: 960°

Personalizable  
Customizable

Bombillas no incluidas  
Bulbs not included

Certificaciones  
Certifications

Recambios / Spare parts:

R03325DIF Difusor / Diffuser

## Descripción lámpara / Lamps description:

230V 50Hz | IP-20 | DALI\* | 6 x 36 W 2G11 |

Ref	Acabados / Finishing	Ean13	Euros
0332506B	Pantalla Cinta Translúcida Blanca White Translucent Ribbon Shade	8436544890906	1.915,00
0332506C	Pantalla Cinta Translúcida Crema Cream Translucent Ribbon Shade	8436544890913	1.915,00
*D0332506B	Regulable Sistema DALI Pantalla Cinta Translúcida Blanca DALI Dimming System White Translucent Ribbon Shade	8436544890937	2.099,00
*D0332506C	Regulable Sistema DALI Pantalla Cinta Translúcida Crema DALI Dimming System Cream Translucent Ribbon Shade	8436544890678	2.099,00

## Familia / Family: Urban

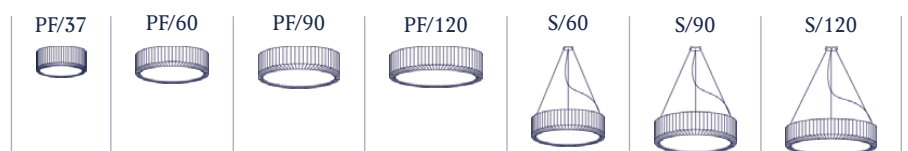

# Urban S/60

Diseño / Design:  
Joana Bover / 2011

Tipología: Suspensión  
Typology: Pendant lamp

Ambiente: Interior  
Environment: Indoor

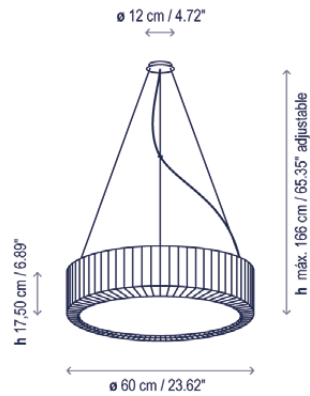

## Descripción técnica / Technical description:

Peso Neto: 6,59 kg  
Net Weight: 6,59 kg

1 Caja/Box | 67 x 67 x 25 cm | 0,1122 m<sup>3</sup>  
Peso bruto / Gross Weight: 8,52 kg

Materiales: Hierro  
Materials: Iron

Difusor superior e inferior: Metacrilato  
Upper and lower diffusers: Methacrylate

Personalizable  
Customizable

Hilo incandescente pantalla: 960°  
Shade GWFI: 960°

Bombillas no incluidas  
Bulbs not included

Certificaciones  
Certifications

Recambios / Spare parts:

R4102325DIF Difusor superior / Upper Diffuser

R02325DIF Difusor inferior + Aro  
Bottom Diffuser + Ring

R907010 Manguera 5x0,75 / Cable 5x0,75

## Descripción lámpara / Lamps description:

230V 50Hz | IP-20 | 4 x 46 W EcoClassic P45 E-27 | 4 x 22 W CFL E-27 | 4 x 6 W LED P45 E-27

Ref	Acabados / Finishing	Ean13	Euros
410232506B	Pantalla Cinta Translúcida Blanca White Translucent Ribbon Shade	8436535539852	627,00
410232506C	Pantalla Cinta Translúcida Crema Cream Translucent Ribbon Shade	8436535539869	627,00

## Descripción lámpara / Lamps description:

120-277V 50/60Hz | IP-20 | 34 W LED / CRI: 90 / 2700°K  
2686 lm fuente de luz / light source

Ref	Acabados / Finishing	Ean13	Euros
610232506B	LED dimable TRIAC Pantalla Cinta Translúcida Blanca LED TRIAC Dimmable White Translucent Ribbon Shade	8436544892153	817,00
610232506C	LED dimable TRIAC Pantalla Cinta Translúcida Crema LED TRIAC Dimmable Cream Translucent Ribbon Shade	8436544892191	817,00

## Familia / Family: Urban

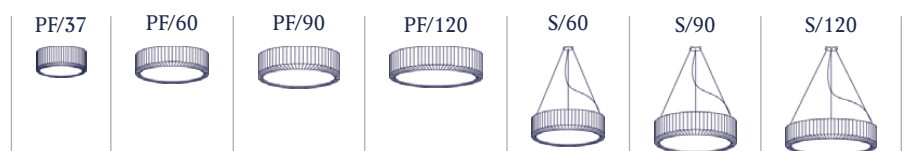

# Urban S/90

Diseño / Design:  
Joana Bover / 2011

Tipología: Suspensión  
Typology: Pendant lamp

Ambiente: Interior  
Environment: Indoor

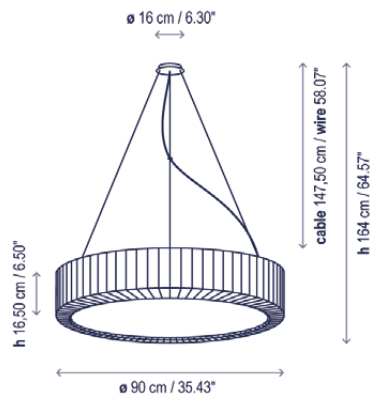

## Descripción técnica / Technical description:

Peso Neto: 9,85 kg  
Net Weight: 9,85 kg

1 Caja/Box | 91 x 92 x 26 cm | 0,2177 m<sup>3</sup>  
Peso bruto / Gross Weight: 14,06 kg

Materiales: Hierro  
Materials: Iron

Difusor superior e inferior: Metacrilato  
Upper and lower diffusers: Methacrylate

Personalizable  
Customizable

Hilo incandescente pantalla: 960°  
Shade GWF: 960°

Bombillas no incluidas  
Bulbs not included

Certificaciones  
Certifications

Recambios / Spare parts:

R4104325DIF Difusor superior / Upper Diffuser  
R04325DIF Difusor inferior / Bottom Diffuser

## Descripción lámpara / Lamps description:

230V 50Hz | IP-20 | 6 x 22 W CFL E-27 | 6 x 9 W LED A60 E-27

Ref	Acabados / Finishing	Ean13	Euros
410432506B	Pantalla Cinta Translúcida Blanca White Translucent Ribbon Shade	8436544895703	1.461,00
410432506C	Pantalla Cinta Translúcida Crema Cream Translucent Ribbon Shade	8436544895727	1.461,00

Familia / Family: Urban





# Urban S/120

Diseño / Design:  
Joana Bover / 2011

Tipología: Suspensión  
Typology: Pendant lamp

Ambiente: Interior  
Environment: Indoor

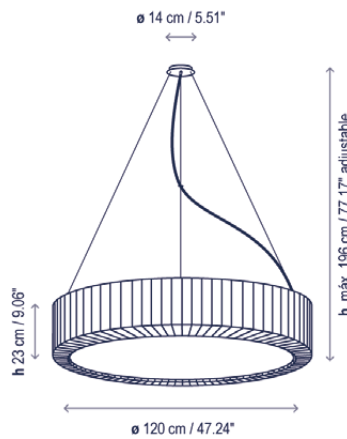

## Descripción técnica / Technical description:

Peso Neto: 18,6 kg  
Net Weight: 18,6 kg

1 Caja/Box | 127 x 128 x 45 cm | 0,7315 m<sup>3</sup>  
Peso bruto / Gross Weight: 33,16 kg

Materiales: Hierro  
Materials: Iron

Difusor superior e inferior: Metacrilato  
Upper and lower diffusers: Methacrylate

Hilo incandescente pantalla: 960°  
Shade GWFI: 960°

Personalizable  
Customizable

Bombillas no incluidas  
Bulbs not included

Certificaciones  
Certifications

Recambios / Spare parts:

R4103325DIF Difusor superior / Upper Diffuser  
R03325DIF Difusor inferior / Bottom Diffuser  
R907001 Manguera 3x0,75 / Cable 3x0,75  
R907010 Manguera 5x0,75 / Cable 5x0,75

## Descripción lámpara / Lamps description:

230V 50Hz IP-20 6 x 36 W 2G11

Ref	Acabados / Finishing	Ean13	Euros
410332506B	Pantalla Cinta Translúcida Blanca White Translucent Ribbon Shade	8436535539883	2.402,00
410332506C	Pantalla Cinta Translúcida Crema Cream Translucent Ribbon Shade	8436535539890	2.402,00
*D410332506B	Regulable Sistema DALI Pantalla Cinta Translúcida Blanca DALI Dimming System White Translucent Ribbon Shade	8436544891859	2.600,00
*D410332506C	Regulable Sistema DALI Pantalla Cinta Translúcida Crema DALI Dimming System Cream Translucent Ribbon Shade	8436544891866	2.600,00

## Familia / Family: Urban

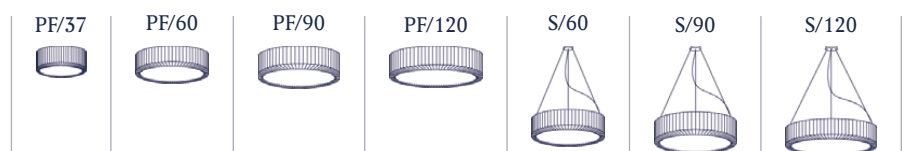

# Wall Street 21

Diseño / Design:  
Joana Bover / 2000

Tipología: Aplique  
Typology: Wall lamp

Ambiente: Interior  
Environment: Indoor

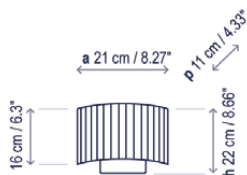

## Descripción técnica / Technical description:

Peso Neto: 0,29 kg  
Net Weight: 0,29 kg

1 Caja/Box | 24 x 22 x 22 cm | 0,0116 m<sup>3</sup>  
Peso bruto / Gross Weight: 0,54 kg

Materiales: Hierro  
Materials: Iron

Caja soporte: 8 x 5 cm  
Surface back box: 3.15" x 1.97"

Hilo incandescente pantalla / Shade GWF1

Cinta / Ribbon: 960°  
Cotonet / Cotton: 750°  
Cotonet Blanco / White Cotton: 800°

Personalizable  
Customizable

Bombillas no incluidas  
Bulbs not included

Certificaciones  
Certifications

## Descripción lámpara / Lamps description:

230V 50Hz | IP-20 | 1 x 30 W EcoClassic P45 E-27 | 1 x 6 W LED E-27 P45

Ref	Acabados / Finishing	Ean13	Euros
1118505/P356	Níquel Satinado Pantalla Cinta Translúcida Blanca Satin Nickel White Translucent Ribbon Shade	8435493702001	137,00
1118505/P355	Níquel Satinado Pantalla Cinta Translúcida Crema Satin Nickel Cream Translucent Ribbon Shade	8435493701998	137,00
1118505/P347	Níquel Satinado Pantalla Cotonet Satin Nickel Cotton Shade	8435493701981	118,00
1118505/P342	Níquel Satinado Pantalla Cotonet Blanco Satin Nickel White Cotton Shade	8435493701950	118,00

Familia / Family: Wall Street

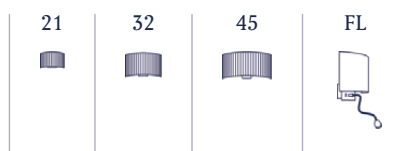

# Wall Street 32

Diseño / Design:  
Joana Bover / 2000

Tipología: Aplique  
Typology: Wall lamp

Ambiente: Interior  
Environment: Indoor

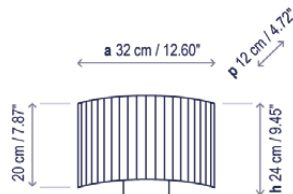

## Descripción técnica / Technical description:

Peso Neto: 0,37 kg  
Net Weight: 0,37 kg

1 Caja/Box | 14 x 47 x 24 cm | 0,0158 m<sup>3</sup>  
Peso bruto / Gross Weight: 0,73 kg

Materiales: Hierro  
Materials: Iron

Caja soporte: 8 x 5 cm  
Surface back box: 3.15" x 1.97"

Hilo incandescente pantalla / Shade GWF1

Cinta / Ribbon: 960°  
Cotonet / Cotton: 750°  
Cotonet Blanco / White Cotton: 800°

Personalizable  
Customizable

Bombillas no incluidas  
Bulbs not included

Certificaciones  
Certifications

## Descripción lámpara / Lamps description:

230V 50Hz | IP-20 | 1 x 30 W EcoClassic P45 E-27 | 1 x 6 W LED E-27 P45

Ref	Acabados / Finishing	Ean13	Euros
1118505/P334	Níquel Satinado Pantalla Cinta Translúcida Blanca Satin Nickel White Translucent Ribbon Shade	8435493701912	140,00
1118505/P333	Níquel Satinado Pantalla Cinta Translúcida Crema Satin Nickel Cream Translucent Ribbon Shade	8435493722405	140,00
1118505/P339	Níquel Satinado Pantalla Cotonet Satin Nickel Cotton Shade	8435493701943	124,00
1118505/P332	Níquel Satinado Pantalla Cotonet Blanco Satin Nickel White Cotton Shade	8435493701905	124,00

Familia / Family: Wall Street

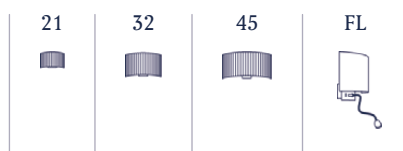

# Wall Street 45

Diseño / Design:  
Joana Bover / 2000

Tipología: Aplique  
Typology: Wall lamp

Ambiente: Interior  
Environment: Indoor

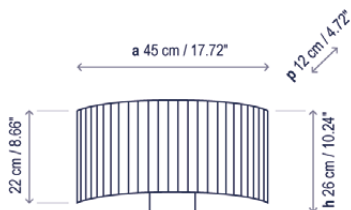

## Descripción técnica / Technical description:

Peso Neto: 0,43 kg  
Net Weight: 0,43 kg

1 Caja/Box | 48 x 20 x 28 cm | 0,0269 m<sup>3</sup>  
Peso bruto / Gross Weight: 0,89 kg

Materiales: Hierro  
Materials: Iron

Caja soporte: 8 x 5 cm  
Surface back box: 3.15" x 1.97"

Hilo incandescente pantalla / Shade GWF1

Cinta / Ribbon: 960°  
Cotonet / Cotton: 750°  
Cotonet Blanco / White Cotton: 800°

Personalizable  
Customizable

Bombillas no incluidas  
Bulbs not included

Certificaciones  
Certifications

## Descripción lámpara / Lamps description:

230V 50Hz | IP-20 | 1 x 30 W EcoClassic P45 E-27 | 1 x 6 W LED E-27 P45

Ref	Acabados / Finishing	Ean13	Euros
1118505/P299	Níquel Satinado Pantalla Cinta Translúcida Blanca Satin Nickel White Translucent Ribbon Shade	8435493701899	147,00
1118505/P298	Níquel Satinado Pantalla Cinta Translúcida Crema Satin Nickel Cream Translucent Ribbon Shade	8435493701882	147,00
1118505/P296	Níquel Satinado Pantalla Cotonet Satin Nickel Cotton Shade	8435493701868	128,00
1118505/P297	Níquel Satinado Pantalla Cotonet Blanco Satin Nickel White Cotton Shade	8435493701875	128,00

Familia / Family: Wall Street

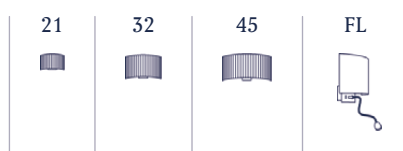

# Wall Street FL

Diseño / Design:  
Joana Bover / 2000

Tipología: Aplique  
Typology: Wall lamp

Ambiente: Interior  
Environment: Indoor

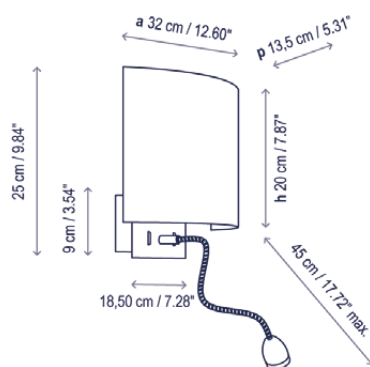

## Descripción técnica / Technical description:

Peso Neto: 0,99 kg  
Net Weight: 0,99 kg

1 Caja/Box | 47 x 47 x 37 cm | 0,0817 m<sup>3</sup>  
Peso bruto / Gross Weight: 3,11 kg

Materiales: Hierro, Latón  
Materials: Iron, Brass

Caja soporte: 16,8 x 7,6 cm  
Surface back box: 6.61" x 2.99"

Hilo incandescente pantalla / Shade GWF1

Cinta / Ribbon: 960°

Cotonet / Cotton: 750°

Cotonet Blanco / White Cotton: 800°

Personalizable  
Customizable

Bombillas no incluidas  
Bulbs not included

Certificaciones  
Certifications

Recambios / Spare parts:

RDRIVER Alimentador LED / LED Driver

## Descripción lámpara / Lamps description:

230V 50Hz IP-20 1 x 46 W EcoClassic P45 E-27 1 x 14 W CFL E-27 1 x 6 W LED P45 E-27

1,2 W LED / CRI: 90 / 2700°K  
85 lm fuente de luz / light source

Ref	Acabados / Finishing	Ean13	Euros
1118505FL/P334	Níquel Satinado Pantalla Cinta Translúcida Blanca Satin Nickel - White Translucent Ribbon Shade	8435493702032	339,00
1118505FL/P333	Níquel Satinado Pantalla Cinta Translúcida Crema Satin Nickel - Cream Translucent Ribbon Shade	8435493702025	339,00
1118505FL/P339	Níquel Satinado Pantalla Cotonet Satin Nickel - Cotton Shade	8435493702063	322,00
1118505FL/P332	Níquel Satinado Pantalla Cotonet Blanco Satin Nickel - White Cotton Shade	8435493702018	322,00
1118505FL/P338	Níquel Satinado Pantalla Plisada Satin Nickel - Pleated Shade	8435493702056	339,00
1118506FL/P334	Cromo Brillante Pantalla Cinta Translúcida Blanca Brilliant Chrome - White Translucent Ribbon Shade	8435493702094	339,00
1118506FL/P333	Cromo Brillante Pantalla Cinta Translúcida Crema Brilliant Chrome - Cream Translucent Ribbon Shade	8435493702087	339,00
1118506FL/P339	Cromo Brillante Pantalla Cotonet Brilliant Chrome - Cotton Shade	8435493702124	322,00
1118506FL/P332	Cromo Brillante Pantalla Cotonet Blanco Brilliant Chrome - White Cotton Shade	8435493702070	322,00
1118506FL/P338	Cromo Brillante Pantalla Plisada Brilliant Chrome - Pleated Shade	8435493702117	339,00

## Familia / Family: Wall Street

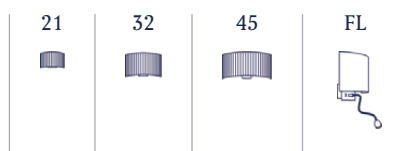

# Recambios y Accesorios

## *Spare Parts & Accessories*



## Florón Slend / Slend Canopy - Set 3 Circular



← →  
ø 32 cm / 12.60"

Ref	Acabados / Finishing	Ean13	Euros
2560090001	Blanco Brillo / Brilliant White	8436544895246	149,00
2560090023	Negro Brillo / Brilliant Black	8436544895420	149,00



 1 Caja/Box | 45 x 45 x 10 cm | Vol. 0,0202 m<sup>3</sup> | Peso/Weight: 2,51 kg

## Florón Slend / Slend Canopy - Set 6 Circular

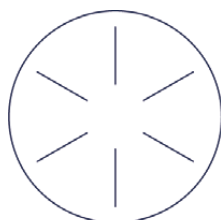

← →  
ø 53 cm / 20.87"

Ref	Acabados / Finishing	Ean13	Euros
2560090101	Blanco Brillo / Brilliant White	8436544895291	362,00
2560090123	Negro Brillo / Brilliant Black	8436544895345	362,00



 1 Caja/Box | 55 x 55 x 25 cm | Vol. 0,0756 m<sup>3</sup> | Peso/Weight: 4,11 kg

## Florón Slend / Slend Canopy - Set 3 Rectangular

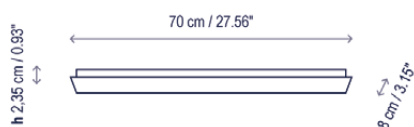

Ref	Acabados / Finishing	Ean13	Euros
2560090201	Blanco Brillo / Brilliant White	8436544895369	154,00
2560090223	Negro Brillo / Brilliant Black	8436544895406	154,00



 1 Caja/Box | 79 x 16 x 14 cm | Vol. 0,0177 m<sup>3</sup> | Peso/Weight: 2,83 kg

# Recambios y Accesorios / Spare Parts and Accessories

Familia/Family	Ref	Descripción / Description	EAN	Euros
Accesorios/Spare Parts	R411301	Tensor acero 1,5 mt + terminal / Tensor wire 1,5 mt + finial	8436047302333	11,00
	R411303	Tensor acero 3 mt + terminal / Tensor wire 3 mt + finial	8436047302340	12,00
	R411305	Tensor acero 5 mt + terminal / Tensor wire 5 mt + finial	8436047302357	15,00
	R906019N	Cable Coaxial Negro (precio metro) / Black coaxial cable (price per meter)	8436535536141	7,00
	R907001	Manguera transparente PVC 3x0,75 (1 mt) / Transparent PVC cable 3x0,75 (1 mt)	8436047302364	13,00
	R907007	Cable Neopreno Negro 3x1 (precio metro) / Neoprene Cable Black 3x1 (price per meter)	8436544890869	11,00
	R907010	Manguera transparente PVC 5x0,75 (1 mt) / Transparent PVC cable 5x0,75 (1 mt)	8436544892481	17,00
	RDRIVER	Alimentador LED / LED Driver	8436544890647	30,00
	RSUSP	Suspensión inox / Inox suspension	8436047309622	13,00
Atticus	R950001	Batería / Battery	8436544898186	59,00
Amphora	R3300114	Anclaje marrón / Brown anchorage	8435493724362	32,00
	R33014	Anclaje marrón / Brown anchorage	8436535535564	40,00
BCN	R26518PC	Difusor de policarbonato / Polycarbonate diffuser	8436544896113	32,00
	R26532PC	Difusor de policarbonato / Polycarbonate diffuser	8436544896137	59,00
Cornet	R34036	CORNET B/27-52-77 accesorio anclaje cimentación / Anchoring for foundation CORNET B/27-52-77	8436544895109	63,00
Danona	R20231DIF	Difusor / Diffuser	8436544890500	19,00
	R30231DIF	Difusor / Diffuser	8436544890531	23,00
	R21231DIF	Difusor / Diffuser	8436544890692	14,00
Domita	R25861671	SopORTE Cable Eléctrico Níquel / Electrical Cable Support Nickel	8435493726908	30,00
	RSUB258922114	Pantalla Madera Domita S/20 / Wood Shade Domita S/20	8435493725826	194,00
Drip/Drop	R2590356	Cristal Drop transparente / Drop transparent glass	8436544898148	62,00
	R2590357	Cristal Drop matizado / Drop frosted glass	8436544898155	62,00
	R2590358	Cristal Drop verde / Drop green glass	8436544898162	62,00
	R2590359	Cristal Drop azul / Drop blue glass	8436544898179	62,00
	R259124	Policarbonato Opal Drip / Drip Opal Polycarbonate	8435493725208	42,00
	R2599438	Cristal Drip transparente / Drip Transparent glass	8436544898100	62,00
	R2599439	Cristal Drip matizado / Drip frosted glass	8436544898117	62,00
	R2599481	Cristal Drip verde / Drip green glass	8436544898124	62,00
	R2599486	Cristal Drip azul / Drip blue glass	8436544898131	62,00
	R25999901	Set Foco Susp Drip/Drop Multiple N°1 - 710mm / Optical Set Multiple Drip/Drop N°1 - 710mm	8435493722504	80,00
	R25999902	Set Foco Susp Drip/Drop Multiple N°2 - 960mm / Optical Set Multiple Drip/Drop N°2 - 960mm	8435493722566	80,00
	R25999903	Set Foco Susp Drip/Drop Multiple N°3 - 1210mm / Optical Set Multiple Drip/Drop N°3 - 1210mm	8435493722603	82,00
	R25999904	Set Foco Susp Drip/Drop Multiple N°4 - 1460mm / Optical Set Multiple Drip/Drop N°4 - 1460mm	8435493722689	82,00
	R25999905	Set Foco Susp Drip/Drop Multiple N°5 - 1710mm / Optical Set Multiple Drip/Drop N°5 - 1710mm	8435493722719	83,00
	R25999906	Set Foco Susp Drip/Drop Multiple N°6 - 1960mm / Optical Set Multiple Drip/Drop N°6 - 1960mm	8435493722726	84,00
	R25999907	Set Foco Susp Drip/Drop Multiple N°7 - 2210mm / Optical Set Multiple Drip/Drop N°7 - 2210mm	8435493722733	85,00
R25999908	Set Foco Susp Drip/Drop Multiple N°8 - 2462mm / Optical Set Multiple Drip/Drop N°8 - 2462mm	8435493722740	86,00	
R25999909	Set Foco Susp Drip/Drop Multiple N°9 - 2710mm / Optical Set Multiple Drip/Drop N°9 - 2710mm	8435493722757	87,00	
R25999910	Set Foco Susp Drip/Drop Multiple N°10 - 2960mm / Optical Set Multiple Drip/Drop N°10 - 2960mm	8435493722764	87,00	
R25999911	Set Foco Susp Drip/Drop Multiple N°11 - 3210mm / Optical Set Multiple Drip/Drop N°11 - 3210mm	8435493722771	89,00	
R25999912	Set Foco Susp Drip/Drop Multiple N°12 - 3460mm / Optical Set Multiple Drip/Drop N°12 - 3460mm	8435493722788	89,00	
R25999913	Set Foco Susp Drip/Drop Multiple N°13 - 3710mm / Optical Set Multiple Drip/Drop N°13 - 3710mm	8435493722795	89,00	
Elea	R51326DIF	Difusor de cristal inferior / Bottom glass diffuser	8436047309172	94,00
	R41324DIF	Difusor de cristal superior / Upper glass diffuser	8436544891668	67,00
	R51324DIF	Difusor de cristal inferior / Bottom glass diffuser	8436544891675	210,00
	R41326DIF	Difusor de cristal superior / Upper glass diffuser	8436047309806	85,00
Flexo	R25103N	Cristal Negro / Black Glass	8436544893259	27,00
Garota	AC335001	Florón Garota Catenary S/27/4L Outdoor Negro / Canopy Garota Catenary S/27/4L Outdoor Black	8435493731162	56,00
	R3356988	Fijación a suelo acero inoxidable / Stainless steel floor fastening	8435493722832	112,00
	R3356813	Fijación a suelo blanco roto / Natural white floor fastening	8435493722801	84,00
	R3356814	Fijación a suelo marrón grafito / Graphite brown floor fastening	8435493722818	84,00
	R906015	Cable Neopreno 2x1 Negro (precio metro) / Neoprene Cable 2x1 black (price per meter)	8436535536141	11,00
Hardy	R312	Cristal Hardy / Hardy glass	8436544891705	54,00

# Recambios y Accesorios / Spare Parts and Accessories

Familia/Family	Ref	Descripción / Description	EAN	Euros
Mar	R100	Sujeción Difusor (4 unidades) / Diffuser Hooks (4 units)	8436047306003	23,00
	RMARDIF	Difusor / Diffuser	8436544891811	50,00
Maxi	R907005	Cable transparente PVC 2x0,75 (1 mt) / Transparent PVC cable 2x0,75 (1 mt)	8436544894942	10,00
Mei	R100	Sujeción Difusor (4 unidades) / Diffuser Hooks (4 units)	8436047306003	23,00
	R100DIF	Difusor / Diffuser	8436047302944	49,00
	R120DIF	Difusor / Diffuser	8436047303088	63,00
	R125	Sujeción difusor (5 unidades) / Diffuser hook (5 units)	8436544892078	20,00
	R125DIF	Difusor / Diffuser	8436544892054	124,00
	R150	Sujeción difusor (8 unidades) / Diffuser hook (8 units)	8436047306010	22,00
	R150DIF	Difusor / Diffuser	8436047302807	150,00
	R38	Sujeción Difusor (3 unidades) / Diffuser Hooks (3 Units)	8436047300728	23,00
	R38DIF	Difusor / Diffuser	8436047302531	32,00
	R60	Sujeción Difusor (3 unidades) / Diffuser Hooks (3 Units)	8436535530408	23,00
	R60DIF	Difusor / Diffuser	8436047302616	36,00
	R90	Sujeción Difusor (4 unidades) / Diffuser Hooks (4 Units)	8436047305990	23,00
R90DIF	Difusor / Diffuser	8436047300797	64,00	
Moai	R19213	MOAI B/35-60 accesorio de anclaje cimentación / Anchoring for foundation MOAI B/35-60	8436544896861	63,00
Mos	R224DIF1	Difusor cristal opal blanco / Diffuser white opal glass	8436047303200	19,00
	R224DIF2	Difusor cristal opal blanco / Diffuser white opal glass	8436544890609	40,00
	R224DIF3	Difusor cristal opal blanco / Diffuser white opal glass	8436047308984	43,00
Oliver	R313PLF	Cristal Oliver / Oliver Glass	8436544891729	85,00
	R313SUSP	Cristal Oliver / Oliver Glass	8436544893228	112,00
Oval	R21250D	Difusor cristal negro / Diffuser black glass	8436047303453	45,00
	R21250B	Base cristal negro / Base black glass	8436047309417	33,00
	R199	Sujeción difusor (4 unidades) / Diffuser hooks (4 units)	8436544896861	22,00
	R199DIF	Difusor / Diffuser	8436544890210	82,00
Penta	R906019N	Cable Coaxial Negro (precio metro) / Black coaxial cable (price per meter)	8436535536141	7,00
	R906014B	Cable Coaxial Blanco (precio metro) / White coaxial cable (price per meter)	8435493723563	14,00
Plafonet	R01249	Cristal óptico mate / Optical matte glass diffuser	8436047304344	40,00
	R02249	Cristal óptico mate / Optical matte glass diffuser	8436047304412	100,00
	R03249	Difusor metacrilato opal / Methacrylate opal diffuser	8436047308625	226,00
Siam	R02320DIF	Difusor: Metacrilato / Methacrylate diffuser	8436047309141	31,00
	R05320DIF	Difusor: Metacrilato / Methacrylate diffuser	8436544894034	26,00
	R03320DIF	Difusor: Metacrilato / Methacrylate diffuser	8436047307277	66,00
	R01320DIF	Difusor: Metacrilato / Methacrylate diffuser	8436047307604	36,00
Skybell	AC357001	Luminaria Skybell 45 cm 30° 2700K Negro Ebano / Skybell Light 45 cm 30° 2700K Black Ebony	8435493725253	73,00
	AC357002	Luminaria Skybell 55 cm 30° 2700K Negro Ebano / Skybell Light 55 cm 30° 2700K Black Ebony	8435493725260	73,00
	AC357003	Luminaria Skybell 65 cm 30° 2700K Negro Ebano / Skybell Light 65 cm 30° 2700K Black Ebony	8435493725284	73,00
	AC357004	Luminaria Skybell 75 cm 30° 2700K Negro Ebano / Skybell Light 75 cm 30° 2700K Black Ebony	8435493725277	77,00
	AC357005	Luminaria Skybell 240 cm 30° 2700K Negro Ebano / Skybell Light 240 cm 30° 2700K Black Ebony	8435493727110	82,00
	AC357006	Luminaria Skybell 45 cm 40° 2700K Negro Ebano / Skybell Light 45 cm 40° 2700K Black Ebony	8435493726960	73,00
	AC357007	Luminaria Skybell 55 cm 40° 2700K Negro Ebano / Skybell Light 55 cm 40° 2700K Black Ebony	8435493726977	73,00
	AC357008	Luminaria Skybell 65 cm 40° 2700K Negro Ebano / Skybell Light 65 cm 40° 2700K Black Ebony	8435493726984	73,00
	AC357009	Luminaria Skybell 75 cm 40° 2700K Negro Ebano / Skybell Light 75 cm 40° 2700K Black Ebony	8435493726991	77,00
	AC357010	Luminaria Skybell 240 cm 40° 2700K Negro Ebano / Skybell Light 240 cm 40° 2700K Black Ebony	8435493727127	82,00
	AC357011	Luminaria Skybell 45 cm 30° 3000K Negro Ebano / Skybell Light 45 cm 30° 3000K Black Ebony	8435493731186	73,00
	AC357012	Luminaria Skybell 55 cm 30° 3000K Negro Ebano / Skybell Light 55 cm 30° 3000K Black Ebony	8435493731254	73,00
	AC357013	Luminaria Skybell 65 cm 30° 3000K Negro Ebano / Skybell Light 65 cm 30° 3000K Black Ebony	8435493731193	73,00
	AC357014	Luminaria Skybell 75 cm 30° 3000K Negro Ebano / Skybell Light 75 cm 30° 3000K Black Ebony	8435493731261	77,00
	AC357015	Luminaria Skybell 240 cm 30° 3000K Negro Ebano / Skybell Light 240 cm 30° 3000K Black Ebony	8435493731278	82,00
	AC357016	Luminaria Skybell 45 cm 40° 3000K Negro Ebano / Skybell Light 45 cm 40° 3000K Black Ebony	8435493731209	73,00
	AC357017	Luminaria Skybell 55 cm 40° 3000K Negro Ebano / Skybell Light 55 cm 40° 3000K Black Ebony	8435493731285	73,00
	../.	AC357018	Luminaria Skybell 65 cm 40° 3000K Negro Ebano / Skybell Light 65 cm 40° 3000K Black Ebony	8435493731292

## Recambios y Accesorios / Spare Parts and Accessories

Familia/Family	Ref	Descripción / Description	EAN	Euros
Skybell	AC357019	Luminaria Skybell 75 cm 40° 3000K Negro Ebano / Skybell Light 75 cm 40° 3000K Black Ebony	8435493731308	77,00
	AC357020	Luminaria Skybell 240 cm 40° 3000K Negro Ebano / Skybell Light 240 cm 40° 3000K Black Ebony	8435493731315	82,00
Spock	R10518	Difusor policarbonato / Polycarbonate diffuser	8436047303927	27,00
Syra	RDIFSYRA45	Difusor cristal / Glass diffuser	8436544895444	60,00
	RDIFSYRA90	Difusor cristal / Glass diffuser	8436544895468	78,00
	R907016	Cable Neopreno 3x1 Blanco (precio metro) / Neoprene Cable White 3x1 (price per meter)	8436544895437	12,00
	RDIFSYRA60	Difusor cristal / Glass diffuser	8436544895451	61,00
Tibeta	R907022	Cable Metálico Cobre 3x18AWG / Copper Metallic Mesh 3x18AWG	8436544896144	18,00
	R907024	Cable Textil Negro 3x0,75 / Black Fabric Cable 3x0,75	8436544896151	14,00
Urban	R01325DIF	Difusor metacrilato + aro / Methacrylate diffuser + ring	8436544890401	138,00
	R02325DIF	Difusor metacrilato + aro / Methacrylate diffuser + ring	8436544890388	257,00
	R03325DIF	Difusor metacrilato / Methacrylate diffuser	8436544890708	185,00
	R04325DIF	Difusor metacrilato / Methacrylate diffuser	8436544895765	161,00
	R4102325DIF	Difusor superior metacrilato / Methacrylate upper diffuser	8436544890524	76,00
	R4103325DIF	Difusor superior metacrilato / Methacrylate upper diffuser	8436544891880	210,00
	R4104325DIF	Difusor superior metacrilato / Methacrylate upper diffuser	8436544895796	156,00

# Reguladores Triac

## *Triac Dimmers*

# Reguladores Triac / Triac Dimmers

- Leading Edge Dimmer
- Trailing Edge Dimmer

Familia / Family	Ref	Descripción / Description	Fabricante / Manufacturer	Modelo / Model
Atticus	3100xxxxxx	Atticus B/56 Outdoor Atticus B/66 Outdoor	BUSCH JAEGER	U-102
			DUWI	ET1 53850
			HPM	400T
BCN	2650101xxx	BCN 01	● CLIPSAL	32V500
			● HPM	CAT300E
			● HPM	CAT400L
			● JUNG	266 GDE
			● KIWI ELECTRONICS	K010L
			● LEGRAND	5734 62
			● MK ELECTRIC	DW480
			● NORTH-WEST	M1500
			● SCHNEIDER	SBD-SPL
			○ BERKER	2874
			○ BUSCH	6513U-102
			○ CLIPSAL	32E450TM
			○ CLIPSAL	32E450UDM
			○ HPM	CAT400T
			○ JUNG	225 TDE
○ MERTEN	SBD315RC (except LMTC10W200)			
	2650201xxx	BCN 02	—	—
Cornet	3400xxxxxx	Cornet A/01 Outdoor Cornet B/27 Outdoor Cornet B/52 Outdoor Cornet B/77 Outdoor	BUSCH JAEGER	U-102
			DUWI	ET1 53850
			HPM	400T
Dome	25806xxxxx 25807xxxxx	Dome 60/01 Dome 60/02	● BUSCH	2250U
			● CHINT	NEW7-305
	● HPM	CAT300E		
	● HPM	CAT400L		
	● KIWI ELECTRONICS	K010L		
	● LEGRAND	5734 62		
	● SCHNEIDER	SBD-SPL		
	○ BERKER	2874		
	○ BUSCH	6513U-102		
	○ CLIPSAL	32E450UDM		
	○ HAGER	WUD		
	○ HPM	CAT400T		
	○ JUNG	225 TDE		
	○ SCHNEIDER	CCTSE12011		
	25809xxxxx 25818xxxxx	Dome 90 Dome 180	CLIPSAL	32E450TM
		CLIPSAL	32E450UDM	
		LUTRON	GXI-3104-T-CE-WH	



# Reguladores Triac / Triac Dimmers

● Leading Edge Dimmer

○ Trailing Edge Dimmer

Familia / Family	Ref	Descripción / Description	Fabricante / Manufacturer	Modelo / Model
Drip/Drop	25903xxxxx	Drip/Drop S/03L	● BUSCH	2250U
			● CHINT	NEW7-305
			● HPM	CAT300E
			● HPM	CAT400L
			● KIWI ELECTRONICS	K010L
			● LEGRAND	5734 62
			● SCHNEIDER	SBD-SPL
			○ BERKER	2874
			○ BUSCH	6513U-102
			○ CLIPSAL	32E450UDM
			○ HAGER	WUD42
	○ HPM	CAT400T		
	○ JUNG	225 TDE		
	○ SCHNEIDER	CCTSE12011		
	25907xxxxx	Drip/Drop S/07L	BUSCH JAEGER	2247U
			BUSCH JAEGER	U-102
			CLIPSAL	32E450LM
			CLIPSAL	32E450UDM
			DUWI	ET 1 53850
			HPM	250T
			HPM	400T
25912xxxxx	Drip/Drop S/12L	BERKER	Tronic-Drehdimmer 286710	
		CLIPSAL	32E450UDM	
		CLIPSAL	Cat 400T	
		CLIPSAL	NO 32E450LM	
		CLIPSAL	NO 32E450TM	
		JUNG	Licht-Management 225 NV DE	
		JUNG	Licht-Management 225 TDE	
Garota	335070xxxx 335011xxxx 335012xxxx	Garota A/01 Outdoor Garota PF/01 Outdoor Garota S/01 Outdoor	● BUSCH	2250U
			● CHINT	NEW7-305
			● HPM	CAT300E
	● HPM	CAT400L		
	● KIWI ELECTRONICS	K010L		
	● LEGRAND	5734 62		
	● SCHNEIDER	SBD-SPL		
	○ BERKER	2874		
	○ BUSCH	6513U-102		
	○ CLIPSAL	32E450UDM		
	○ HAGER	WUD42		
	○ HPM	CAT400T		
	○ JUNG	225 TDE		
	○ SCHNEIDER	CCTSE12011		

# Reguladores Triac / Triac Dimmers

- Leading Edge Dimmer
- Trailing Edge Dimmer

Familia / Family	Ref	Descripción / Description	Fabricante / Manufacturer	Modelo / Model
Marietta	33101xxxxx	Marietta S/32 Outdoor	—	—
Maxi	29501xxxxx	Maxi P/180 Outdoor Maxi S/01 Outdoor	● CHINT	NEW7-305
			● HPM	CAT300E
			● HPM	CAT400L
			● KIWI ELECTRONICS	K010L
			● LEGRAND	5734 62
			● SCHNEIDER	SBD-SPL
			○ BERKER	2874
			○ BUSCH	6513U-102
			○ CLIPSAL	32E450UDM
			○ HAGER	WUD42
Moai	1920xxxxxx	Moai B/35 Outdoor Moai B/60 Outdoor	○ HPM	CAT400T
			○ JUNG	225 TDE
			BUSCH JAEGER	U-102
Mod	2663xxxxxxx	Mod PF/73/3L Mod S/73/3L	○ BUSCH	6513U-102(420W)
			○ BUSCH	6519U(550W)
			○ JUNG	225 TDE(525W)
	2666xxxxxxx	Mod PF/73/6L Mod S/73/6L	● CHINT	NEW7-305
			● HPM	CAT300E
			● HPM	CAT400L
			● KIWI ELECTRONICS	K010L
			● LEGRAND	5734 62
			● SCHNEIDER	SBD-SPL
			○ BERKER	2874
			○ BUSCH	6513U-102
			○ CLIPSAL	32E450UDM
			○ HAGER	WUD42
2669xxxxxxx	Mod PF/73/9L Mod S/73/9L	○ HPM	CAT400T	
		○ JUNG	225 TDE	
		● LUTRON	DVELV-300P-AL	
		● LUTRON	SELV-300P-AL	
		○ LEVITON	ILLUMATECH-IPL06	
		○ LEVITON	SURESLIDE-6672	
		○ LUTRON	CTCL-153P-IV	
○ LUTRON	DVCLV-153P-IV			
○ LUTRON	SCL-153P-AL			

# Reguladores Triac / Triac Dimmers

- Leading Edge Dimmer
- Trailing Edge Dimmer

Familia / Family	Ref	Descripción / Description	Fabricante / Manufacturer	Modelo / Model		
Nón Lá	3320xxxxxx	Nón Lá A/01 Nón Lá A/03 Nón Lá A/04 Nón Lá S Nón Lá Set 3/Rectangular Nón Lá T	● BUSCH	2250U		
			● CHINT	NEW7-305		
			● HPM	CAT300E		
			● HPM	CAT300E		
			● KIWI Electronics	K010L		
			● LEGRAND	5734 62		
			● SCHNEIDER	SBD-SPL		
			○ BERKER	2874		
			○ BUSCH	6513U-102		
			○ CLIPSAL	32E450UDM		
			○ Hager	WUD42		
			○ HPM	CAT400T		
			○ JUNG	225 TDE		
			○ SCHNEIDER	CCTSE12011		
Sisal	2840xxxxxx	Sisal A/01 Outdoor	○ BUSCH	6513U-102(420W)		
			○ BUSCH	6519U(550W)		
			○ CLIPSAL	32E450TM(450W)		
			○ JUNG	225 TDE(525W)		
Tibeta	2570xxxxxx	Tibeta 01 Tibeta 02 Tibeta 03 Tibeta Set 3	—	—		
			—	—		
			—	—		
			—	—		
Tria	208010xxxx	Tria 01	○ BUSCH	6513U-102(420W)		
			○ BUSCH	6519U(550W)		
			○ CLIPSAL	32E450TM(450W)		
			○ JUNG	225 TDE(525W)		
	208020xxxx 208030xxxx 208130xxxx 208160xxxx 208180xxxx	Tria 02 Tria 03 Tria Set 3 Tria Set 6 Tria Set 8	BUSCH-JEAGER	2247U		
			BUSCH-JEAGER	U-102		
			CONTROLUX	AB300		
			DUWI	ETI 53850		
			HPM	CAT 250T		
			HPM	CAT 400T		
			208040xxxx 208050xxxx	Tria 04 Outdoor Tria 05 Outdoor	Bodo Ehmann LICHTREGLER	T39.01
					CLIPSAL	32E450UDM
	CLIPSAL	NO 32E450TM				
	JUNG	Licht-Management 225 NV DE				
	JUNG	Licht-Management 225 TDE				
	JUNG	Licht-Management 225 TDE				

# Reguladores Triac / *Triac Dimmers*

- Leading Edge Dimmer
- Trailing Edge Dimmer

Familia / Family	Ref	Descripción / Description	Fabricante / Manufacturer	Modelo / Model
Twall	19701013xx	Twall LED	● CLIPSAL	32V500
			● HPM	CAT300E
			● HPM	CAT400L
			● JUNG	266 GDE
			● KIWI Electronics	K010L
			● LEGRAND	5734 62
			● MK Electric	DW480
			● NORTH-WEST	M1500
			● SCHENEIDER	SBD-SPL
			○ BERKER	2874
			○ BUSCH	6513U-102
			○ CLIPSAL	32E450TM
			○ CLIPSAL	32E450UDM
			○ HPM	CAT400T
			○ JUNG	225 TDE
○ MERTEN	SBD315RC (except LMTC10W200)			
Urban	710232506x	Urban PF/60	—	—
	610232506x	Urban S/60	—	—

Especificaciones técnicas  
y condiciones de venta  
*Technical Specifications  
& Sales Conditions*

	Solo aislamiento básico. Las partes accesibles están conectadas a una toma de tierra. Toma de tierra: obligatoria.	Only basic insulation, accessible conductors are earthed. Grounding: compulsory.
	Aislamiento básico más aislamiento secundario o ambos sustituidos por un aislamiento reforzado. Toma de tierra: excluida.	Basic Insulation plus second Insulation or both replaced by reinforced Insulation. Grounding: excluded.
	Alimentación de seguridad realizada a muy bajo voltaje. No debe usarse a más de 12V (a 50Hz). Toma de tierra: excluida.	Very low safety supply voltage; not to be used at over 12V (at 50 Hz). Grounding: excluded.
	Aparato adecuado para el montaje directo sobre superficies normalmente inflamables.	Suitable for mounting on normally flammable surfaces.
	Luminarias no adecuadas para el montaje directo en superficies normalmente inflamables.	Products identified with this symbol CANNOT be in contact with normally-flammable materials.
	Todos los productos están fabricados siguiendo las normas de seguridad y electromagnetismo de Europa: EN 60598-1, EN 60598-2-1 y marcado CE.	All products are manufactured according to the set safety and electromagnetism standards of Europe: EN 60598-1, EN 60598-2-1 and marked CE.
	Productos USA - Certificados by UL Standard Safety / Underwriters Laboratories.	US Products - Certified by UL Standard Safety / Underwriters Laboratories.
	Permite importar y comercializar los productos de Bover en Rusia y en la Unión Euroasiática.	It allows to import and sale Bover' products in Russia and the Eurasian Union.
	Dimmer incorporado	Built-in dimmer
	Las medidas se especificarán siempre en cms. l = largo / a = ancho / h = alto / p = profundo / ø = diámetro	Measurements are always given in centimeters. l = length / a = width / h = high / p = deep / ø = diameter
	Índice de protección contra la penetración de cuerpos sólidos y líquidos. La primera cifra indica la penetración de cuerpos sólidos y la segunda cifra la infiltración de agua.	Protection degree offered by the fixture to the ingress of solids and liquids. First figure, protection against solid bodies penetration. Second figure, protection against water penetration.
	Protección completa contra contacto, protección contra penetración de polvo. Protegido contra la penetración de agua en caso de inyección pasajera.	Totally protected against dust ingress. Protected against high pressure water jets from any direction. Limited ingress permitted.
	Protección completa contra contacto, protección contra penetración de polvo. Protegido contra los chorros de agua (desde todas las direcciones).	Full contact protection, protection against dust penetration. Protected against water jets (from all directions).
	Protección completa contra contacto, protección contra sedimentaciones de polvos en el interior. Protegido contra agua pulverizada.	Complete protection against contact, protection against sedimentation of dust inside. Protected against water spray.
	Protección contra cuerpos sólidos de más de 12mm Sin protección contra el agua.	Protected against solid bodies above 12 mm diameter No protected against water.
	Las dimensiones de las cajas y los florones corresponden a la parte externa de los mismos.	Box and canopies dimensions correspond to the external part size.
	Fotometría disponible	Available photometry
	Índice de reproducción cromática	Color rendering index
	Temperatura de color	Color temperature
	Lumen, unidad de medida del flujo luminoso	Lumen, Luminous flux unit measurement
	Digital Addressable Lighting: protocolo estándar digital direccionable para control de sistemas de iluminación.	Digital Addressable Lighting: protocol for control of lighting systems.
	Regulación sin necesidad de línea de control adicional	Regulation without additional control line
	Regulación del flujo luminoso desde el 1% al 100%, instalación de línea adicional de control 2 hilos.	Control of the luminous flux from 1% to 100%, installation of additional control line 2 wires.
	Regulación del flujo luminoso desde 0 (apagado) y el 100%, instalación de línea adicional de control 2 hilos.	Control of the luminous flux from 0 (off) and 100%, installation of additional control line 2 wires.
	Este producto tiene una tarifa de transporte diferenciada	This product has a differentiated shipping rate
	Producto compatible con las regulaciones de la American Disabilities Act.	Product compliant with the American with Disabilities Act regulations.
	Dispositivo regulador de intensidad de la luz por proximidad.	Proximity light intensity control device.
	Prueba de hilo incandescente.	Shade Glow-wire flammability index.
	Indica que el envoltorio, en los puntos que se consideran como más débiles, puede soportar un impacto mecánico nocivo de una pieza poliamida o de acero redondeada de peso 1.7kg y que cayera desde una altura de 295mm.	It indicates that the product, in the points that are considered as weaker, can withstand a harmful mechanical impact of a polyamide piece or rounded steel weighing 1.7kg and falling from a height of 295mm.
	Este símbolo en su equipo o embalaje indica que el presente producto no puede ser tratado como residuo doméstico normal, sino que debe entregarse en el correspondiente punto de recogida de equipos eléctricos y electrónicos. Para recibir información detallada sobre el reciclaje de ese producto, por favor, contacte con su ayuntamiento, su punto de recogida más cercano o el distribuidor donde adquirió el producto.	This symbol on the product or its packaging indicates that it must not be treated as household waste. It should, in fact, be handed at a recognised collection point for recycling electrical and electronic equipment. For more detailed information about the recycling of this product, please contact your local city office, your household waste disposal service or the shop where you purchased the product.



# Terms and conditions

Please read carefully

BOVER IL-LUMINACIO I MOBILIARI reserves the right to cancel any product in the catalogue, modify the measures and finishes of its products or change the current prices without prior notice.  
Property and authority to recover goods remains with BOVER IL-LUMINACIO I MOBILIARI until payment has been made completely.  
This purchase contract is based on the Incoterms 2010.

## WARRANTY

Our products have a warranty of two years from the date of purchase. Warranty will not be considered valid in cases from which defect or damage occurred from inappropriate usage, mishandling, improper installation, any field modifications, or incorrect application of the product.  
Furthermore, for those products using natural materials such as wood or leather and for those products featuring mouth blown glass, minor imperfections of natural occurrence to the typology of material may not be considered as defective.

## PRICES:

Prices do not include VAT.  
Prices do not include bulbs.  
This price list cancels all previous ones.

## ORDERS:

Orders must be sent via fax (938462089) or email to orders@bover.es as well as any modification thereof.  
Orders below 200€ will have a 20€ processing charge.  
Orders cancelled after production has begun, even if not yet shipped; may be subject to a 30% re-stock fee.

## PAYMENT TERMS:

The due date for our invoices is unalterable. In case of delay or return, interests and expenses will be charged. Exceptions to expiration date are not allowed for vacation periods.  
The days of expiration will always be calculated from the date of issue of the commercial invoice, never from the date of issue of the shipment or from the date of receipt of the material.  
The client is not authorized to deduct from the due dates any amount in the form of a claim unless it has been authorized in writing.  
In case the client has not fulfilled his payment commitments, totally or partially, the company reserves the right to modify its commercial conditions.

## FREIGHT TERMS:

Orders will be delivered Ex-Works (EXW) unless otherwise agreed.  
Orders are not delivered to residential addresses.

 This product has a differentiated shipping rate.

## TRANSPORT CLAIMS:

In the event of visible damages in the packaging or product, the client must indicate them on the delivery note of the transport company.  
Inform the seller of the above damages by email or fax within 24 hours, providing a copy of the transport delivery note with all marks indicated.  
Claims for non-visible damages will not be accepted unless marks are indicated in the transport company delivery note.  
Bover will not be responsible for any defects, damages or breakdowns occurred in transport. The transport company will have to assume damages with its transport insurance.

## PRODUCT REPAIRS

All repairs of purchased lamps must be previously authorized by Bover with an authorization number.  
The products must be packed correctly and sent with the authorization number visible on the packaging. On the contrary, Bover reserves the right of not accepting the goods.  
The estimate for repair will be calculated once the goods are in the Bover facilities. The client will assume all transport charges of this repair request.

## RETURNS AND CHANGES

Returns are not accepted.  
All exchanges must be previously approved by Bover with an authorization number.  
Exchanged materials will have a 20% depreciation on the invoiced amount. In case the product has been handled, repair costs will be charged.  
Exchanges will not be accepted after 30 days from the reception of the goods.  
The client will have to send the product to the Bover facilities within 15 days after the authorization date. The product must be shipped on its original packaging and with the authorization number visible on the packaging. On the contrary, Bover reserves the right of not accepting the goods.  
The client will assume all transport charges of this exchange request.  
Resolution on the product will be made within 15 days of the reception.

## ON-LINE

Use of any Bover product require previous written authorization by Bover. Please, request conditions to the commercial department.

## JURISDICTION

In the event of any dispute, it will refer to Spanish Jurisdiction and law and the courts of Barcelona.

The confirmation of the order is considered as the acceptance of the present conditions.

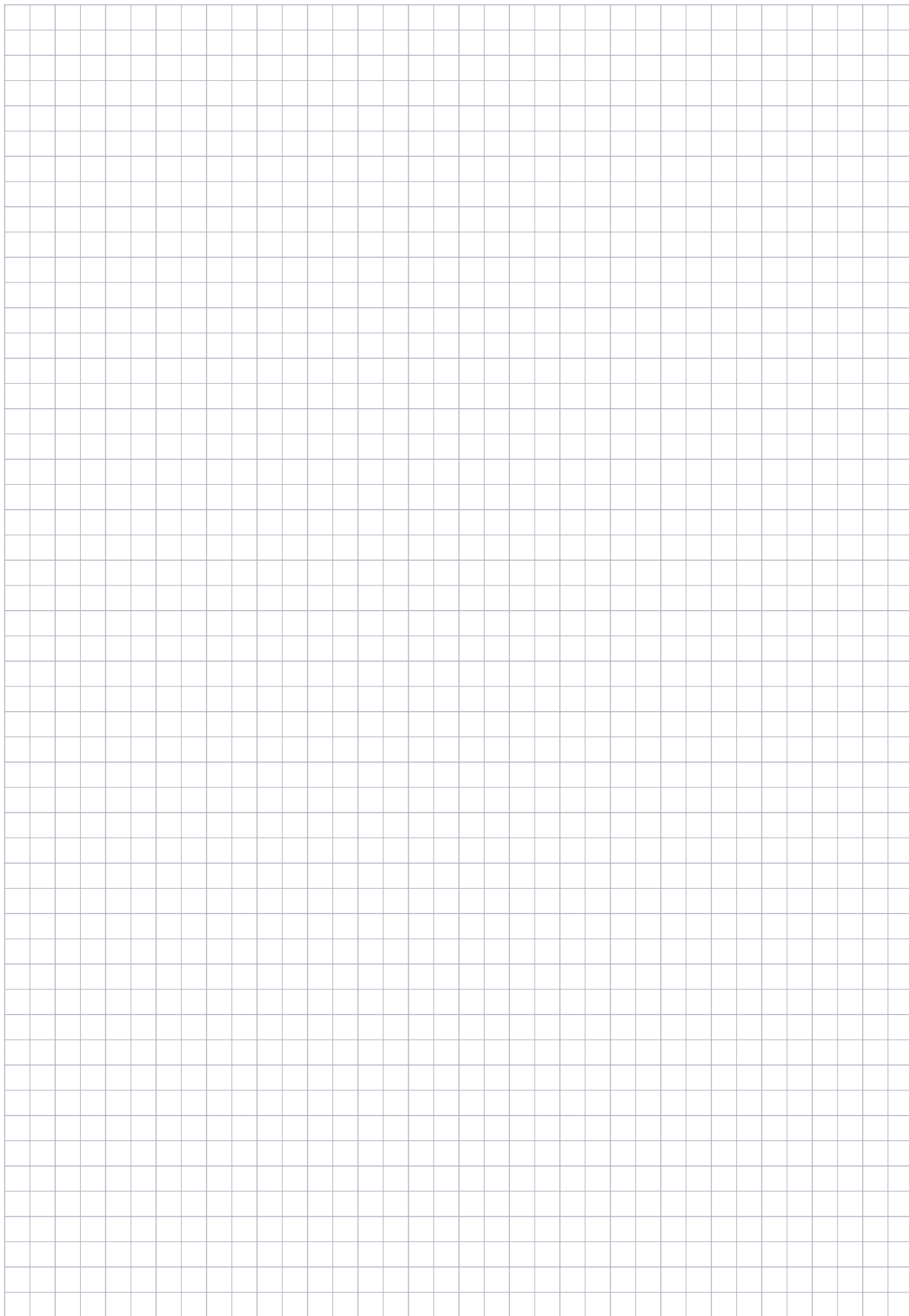

# bover

barcelona lights

---

Avda. Catalunya 173  
Poligon Ind. Sud  
08440 Cardedeu  
Barcelona, Spain

T. +34 938 713 152  
F. +34 938 462 089  
info@bover.es  
www.bover.es

1231 Collier Road,  
Suite C  
Atlanta, GA 30318  
United States

T. +1 (404) 924 2342  
info@boverusa.com  
www.boverusa.com